

1

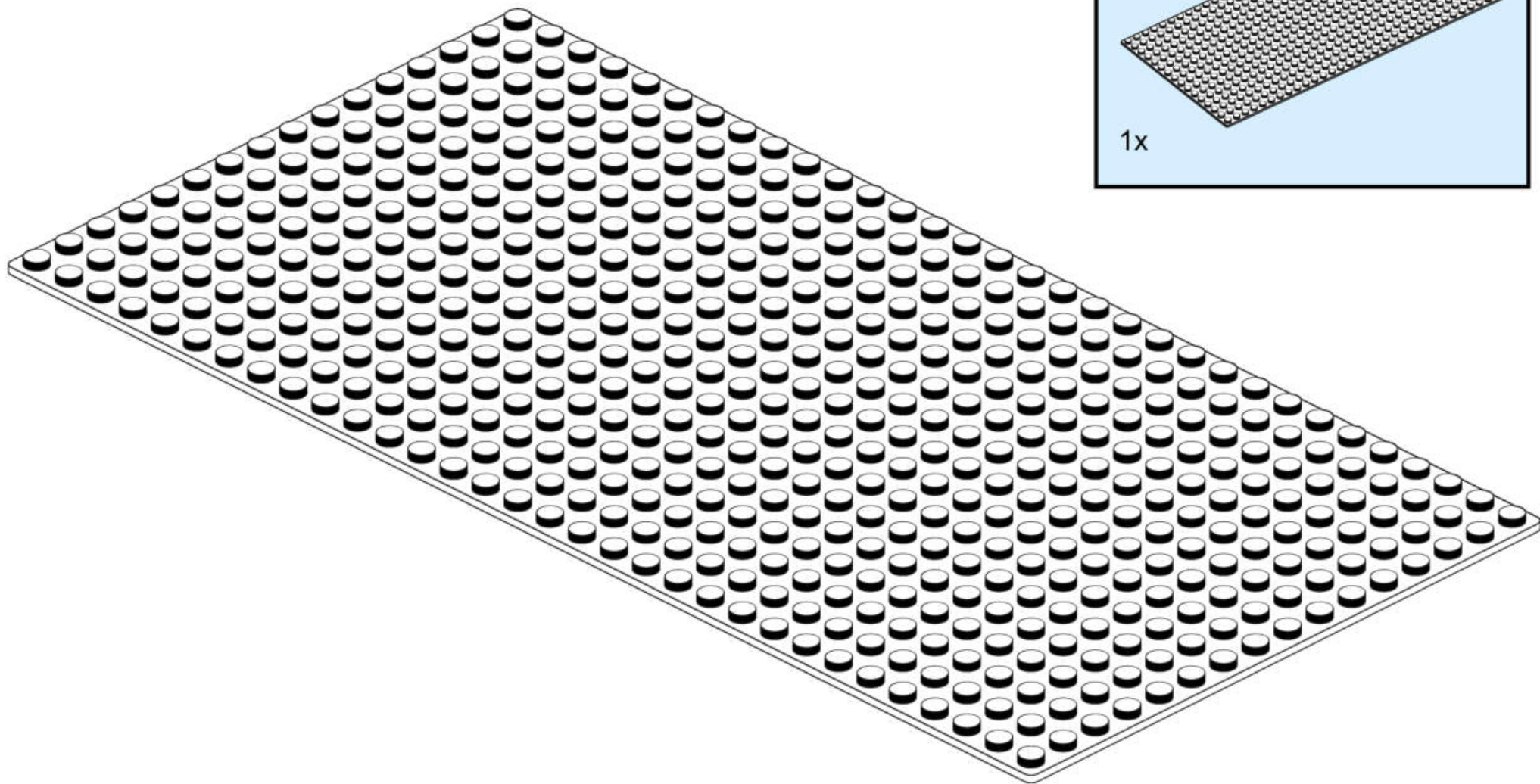

2

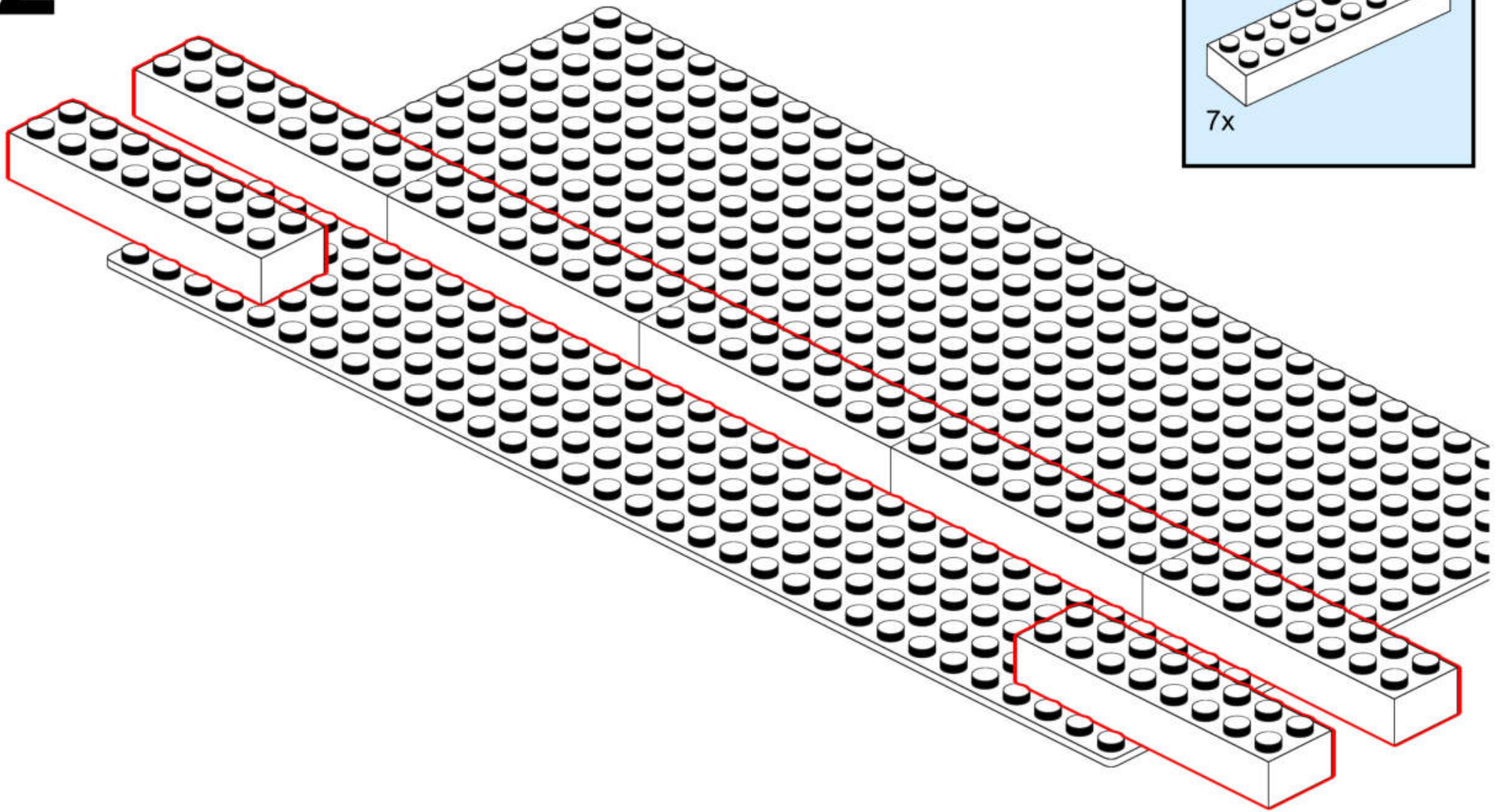



3

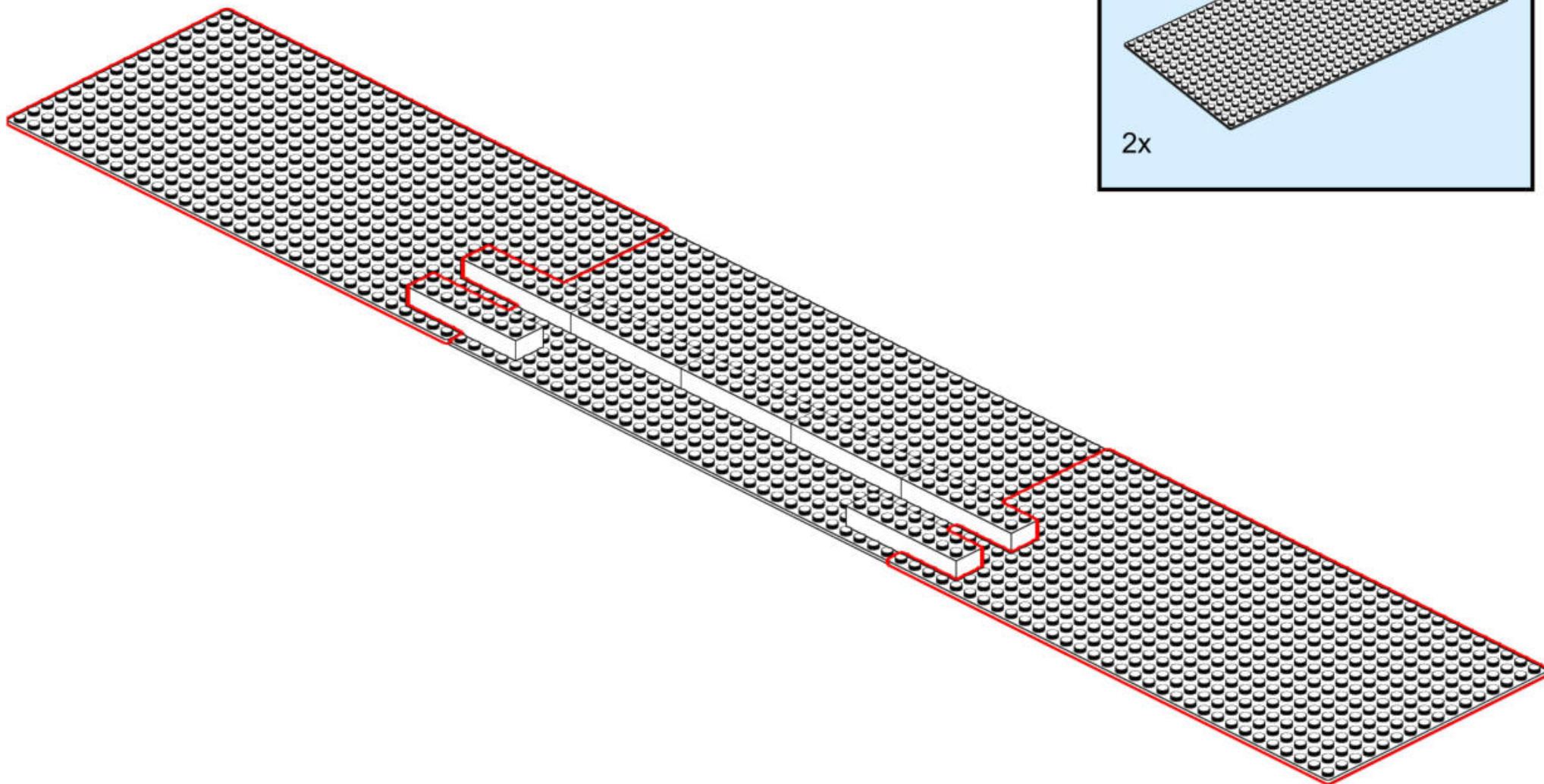



4

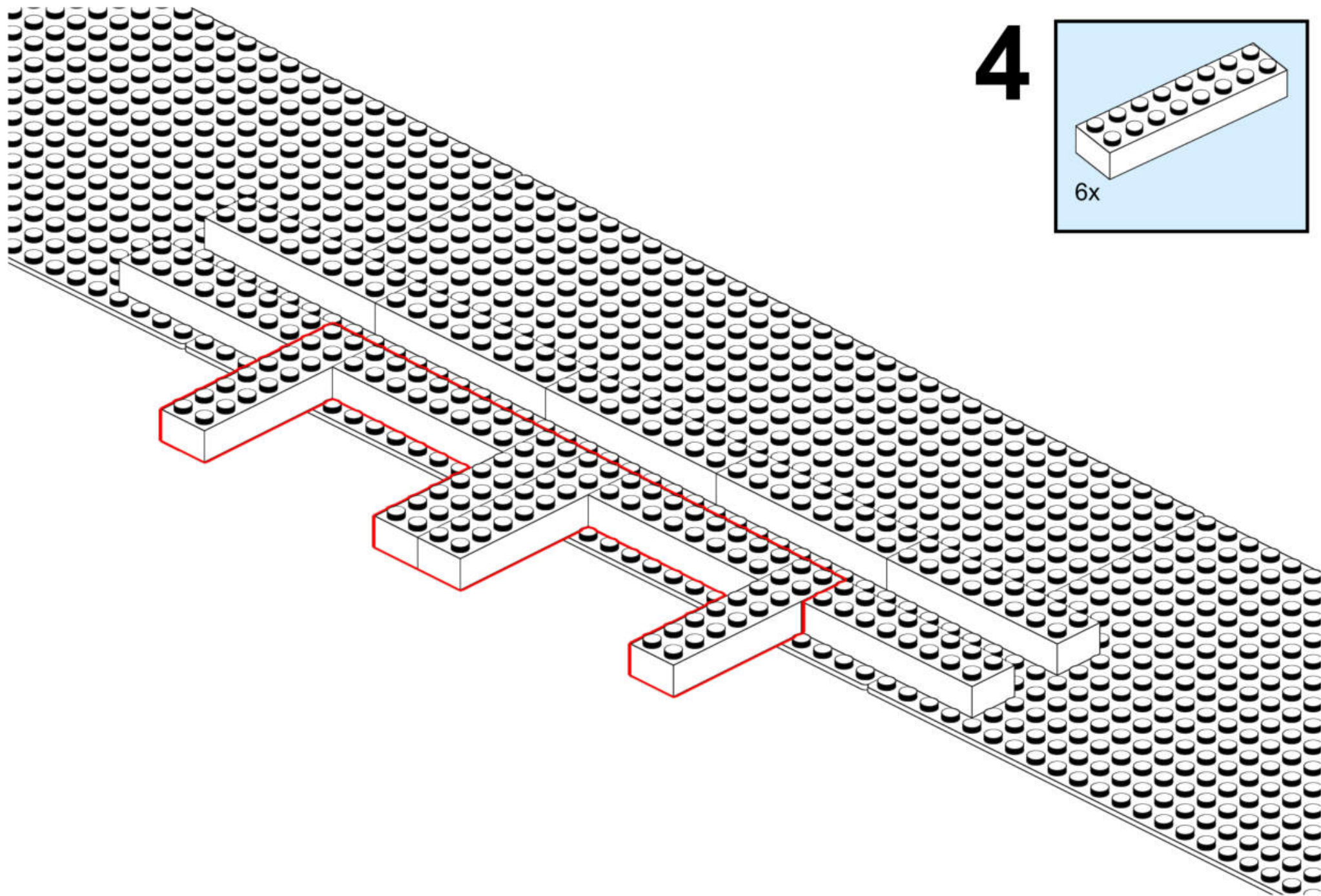
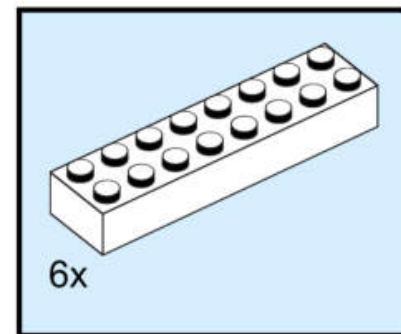

5

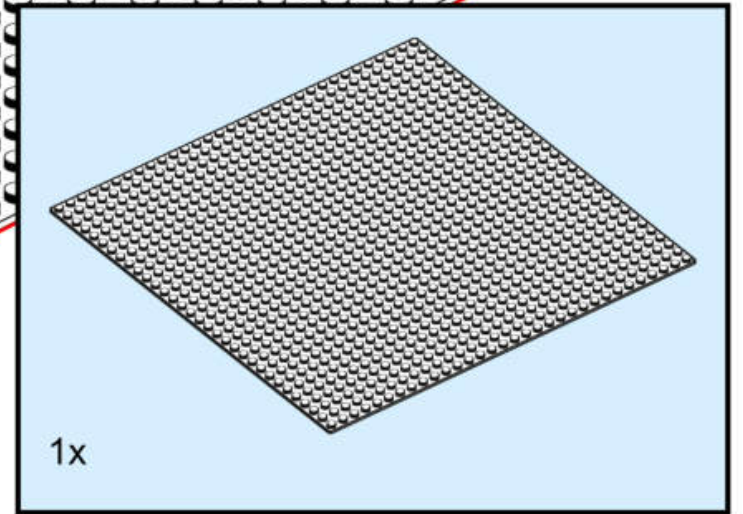
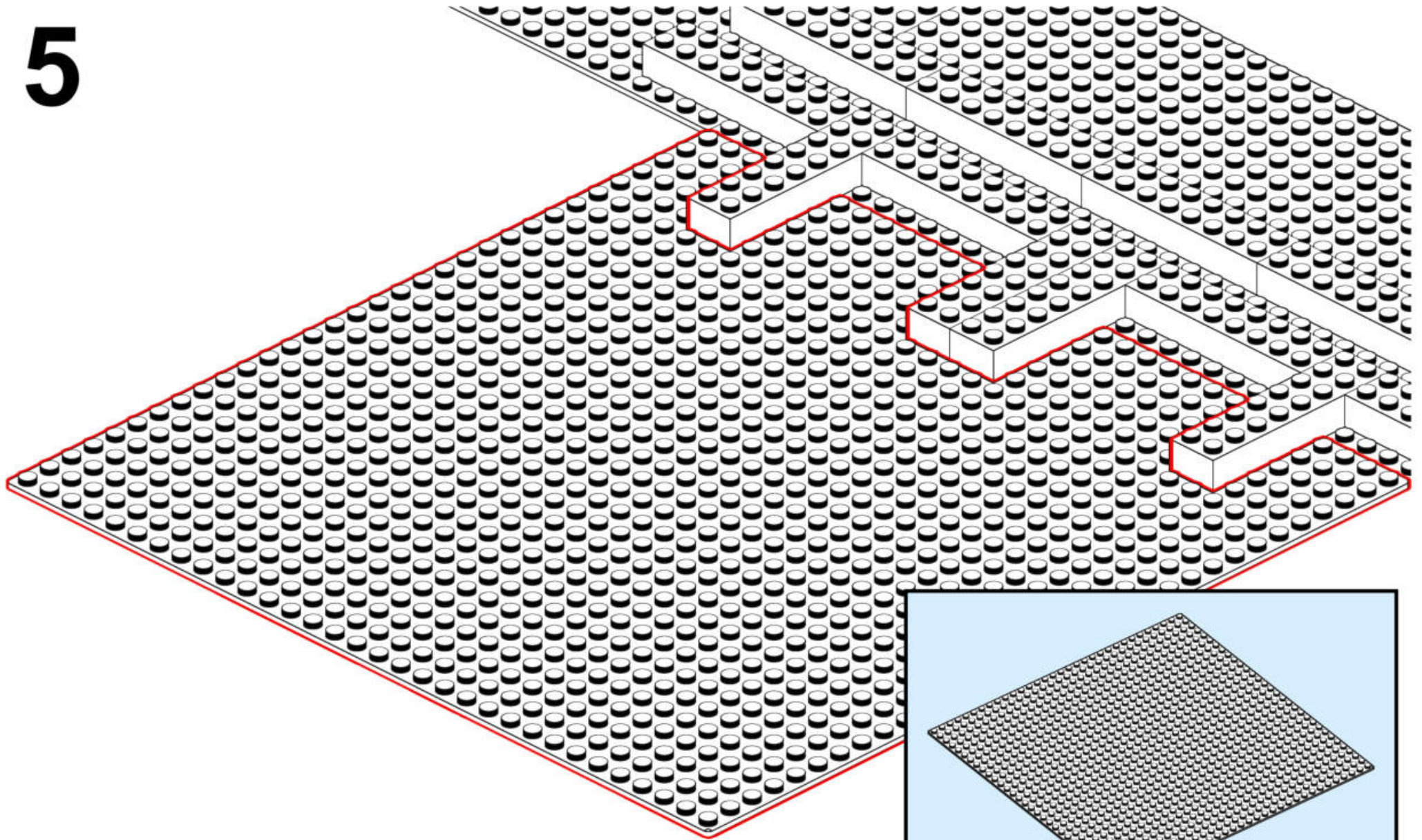



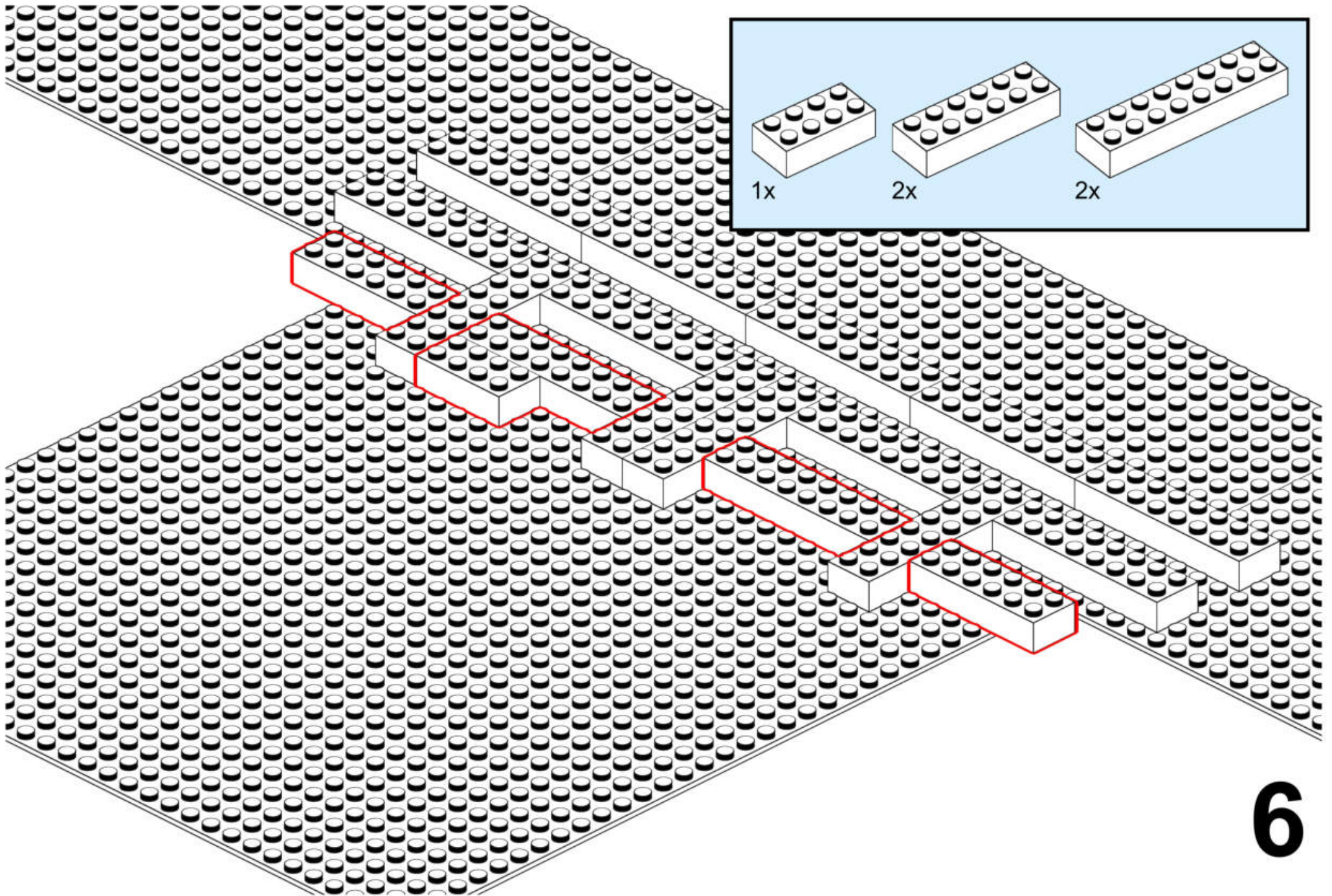

6



7

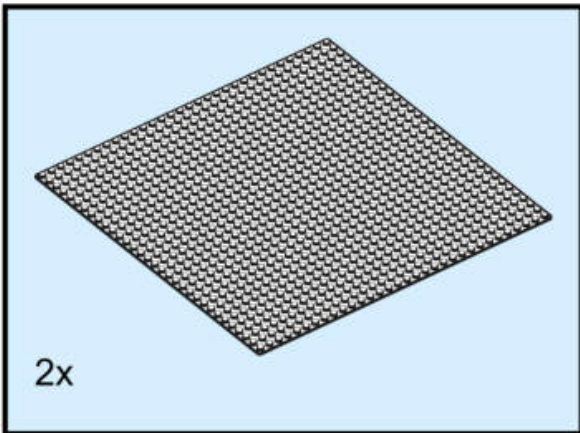
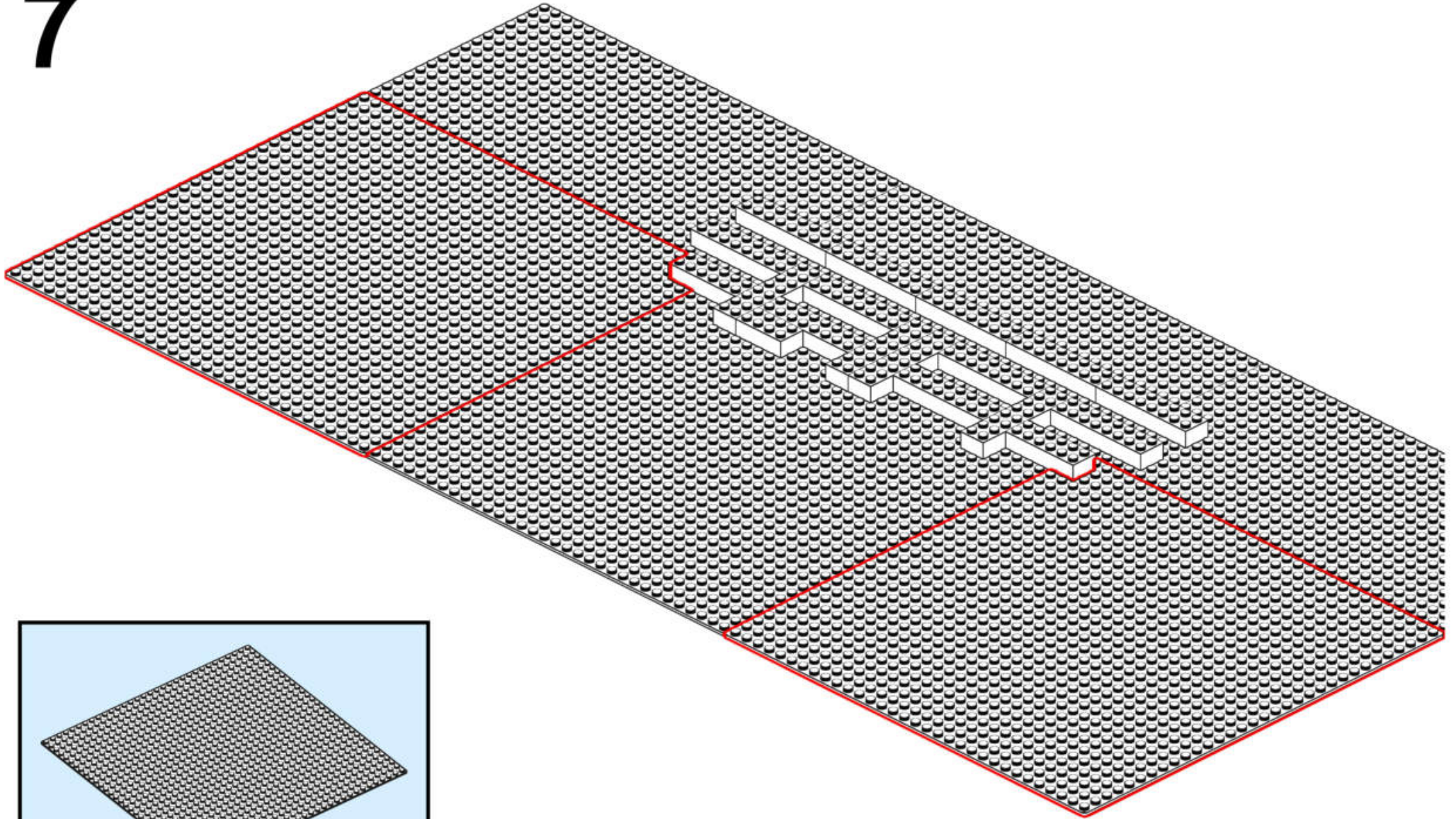



8

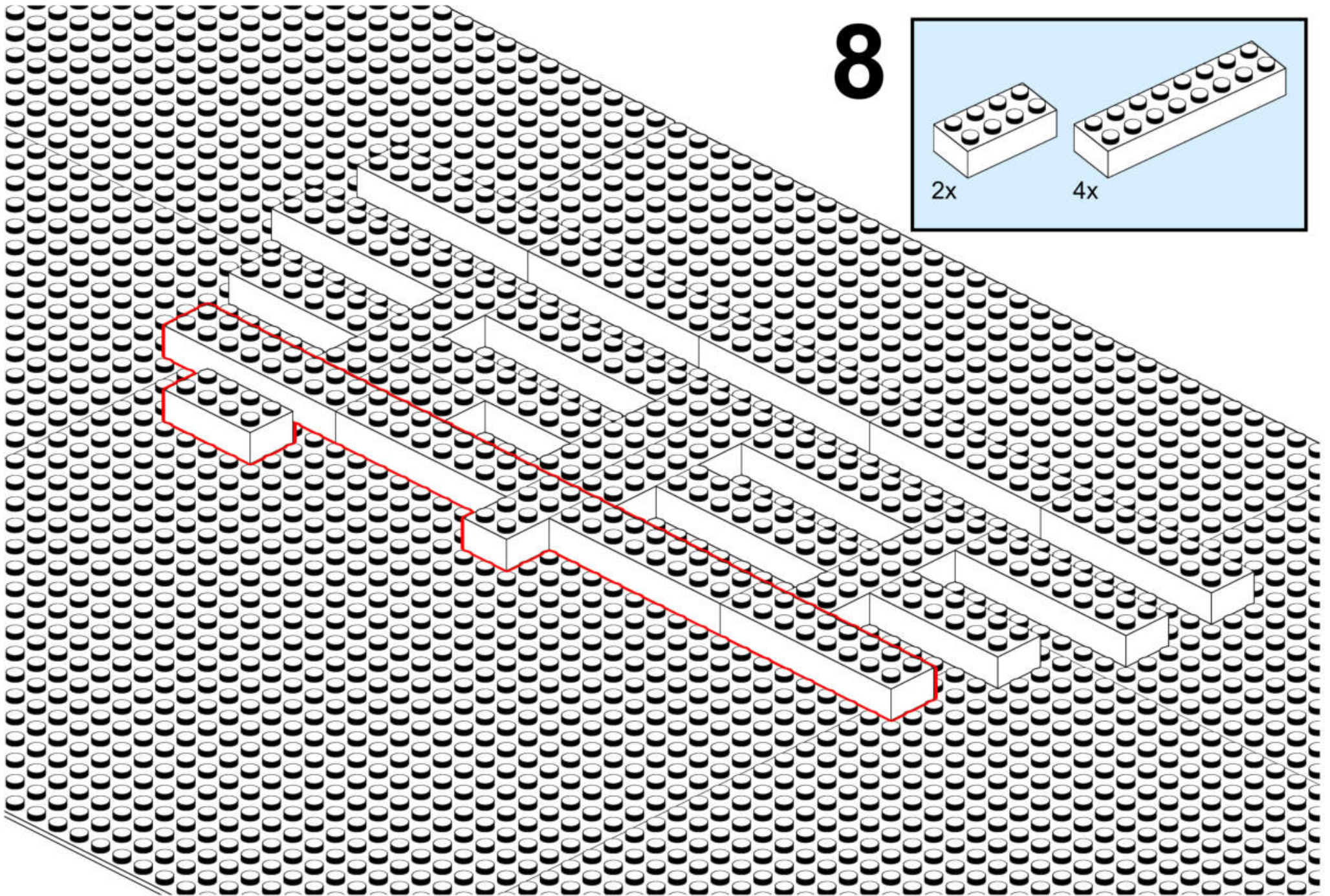
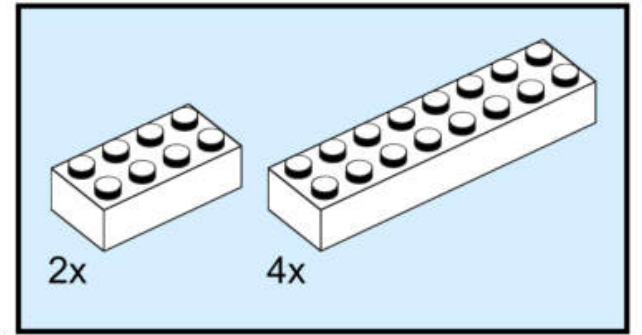



9

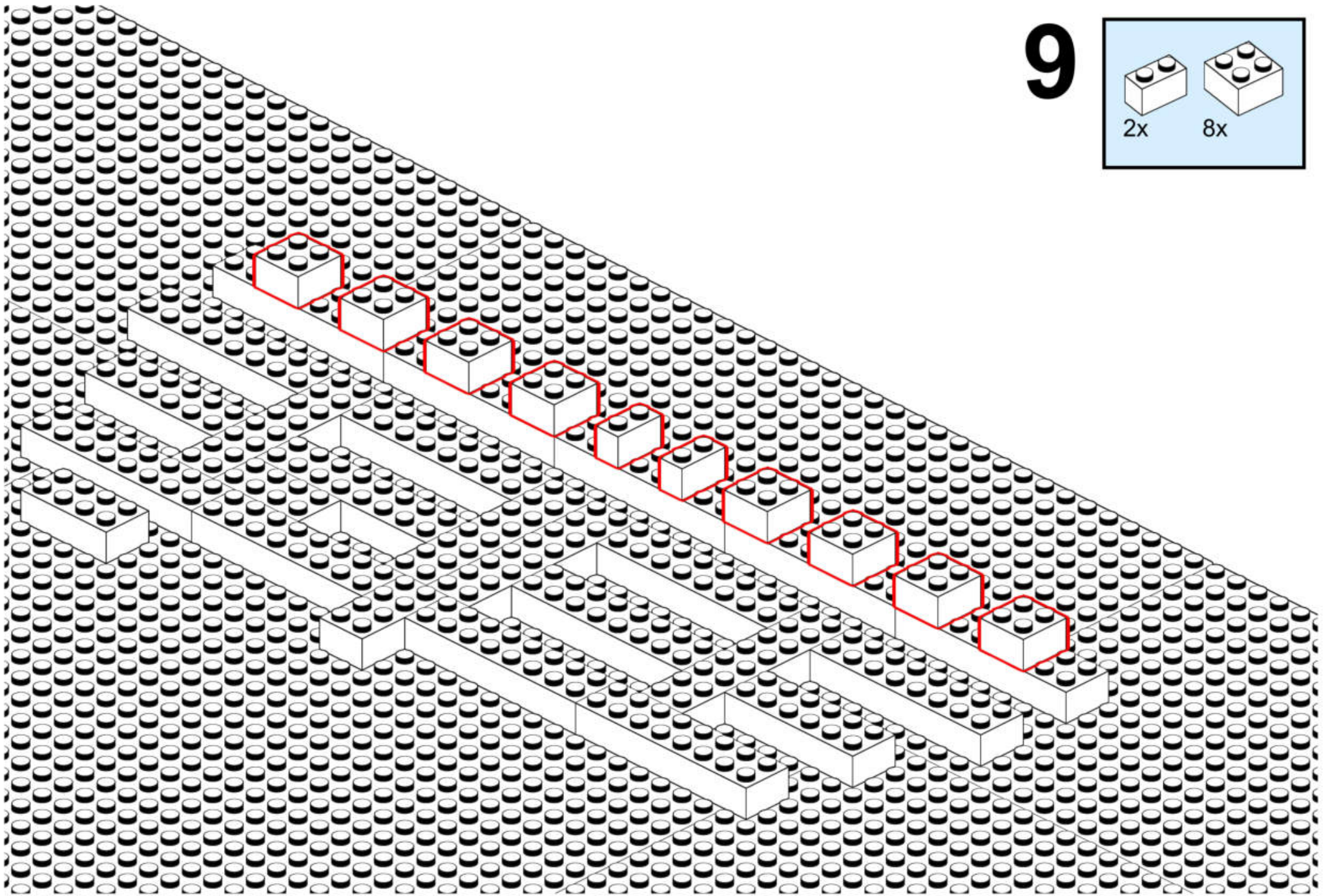
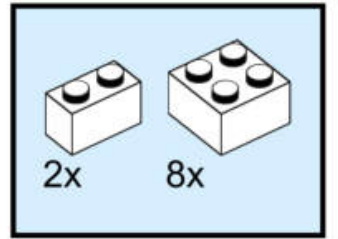



# 10

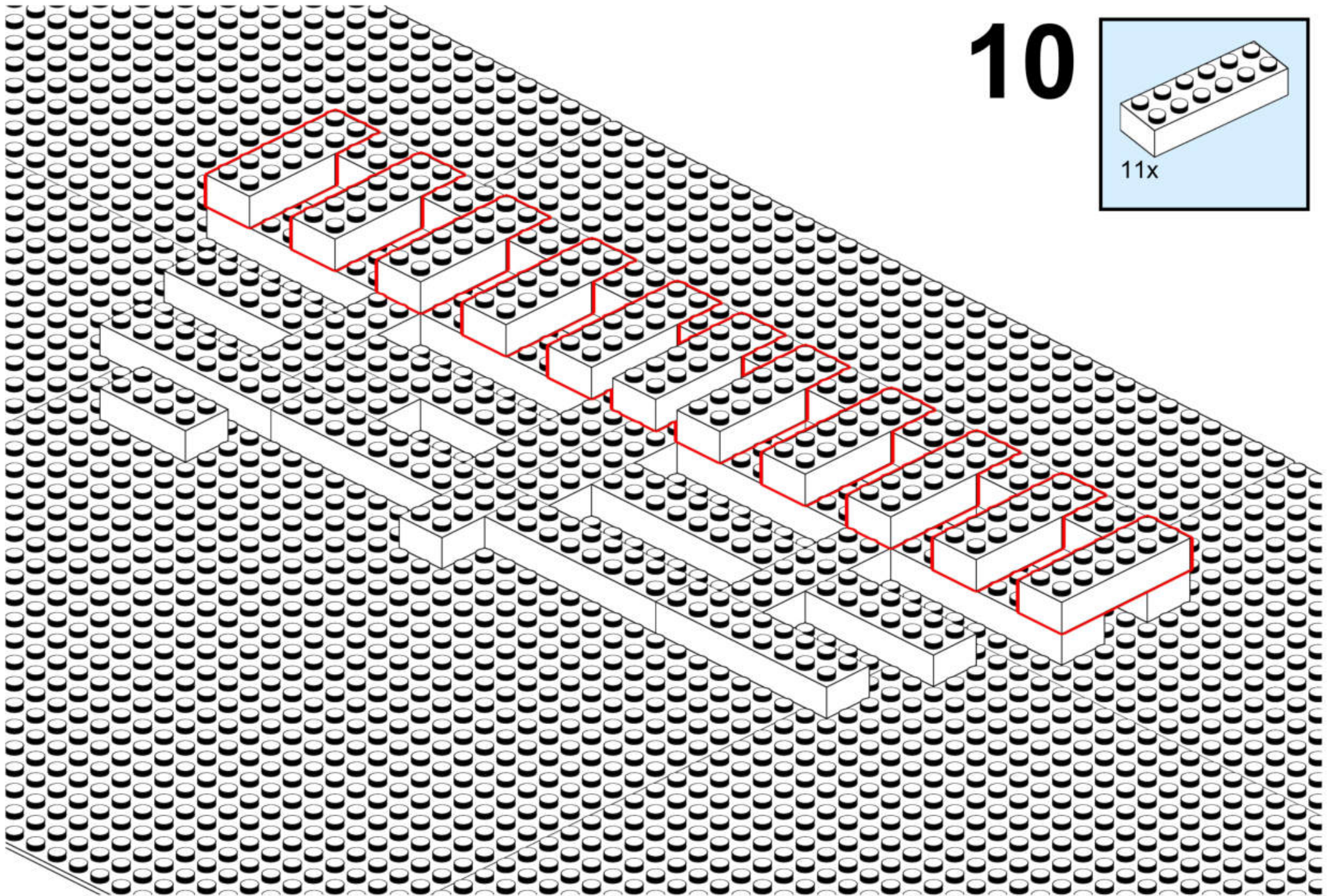
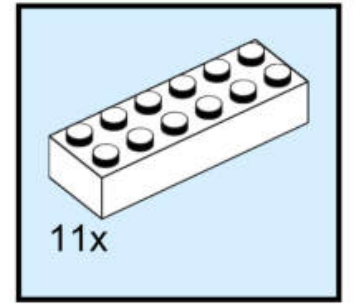



# 11

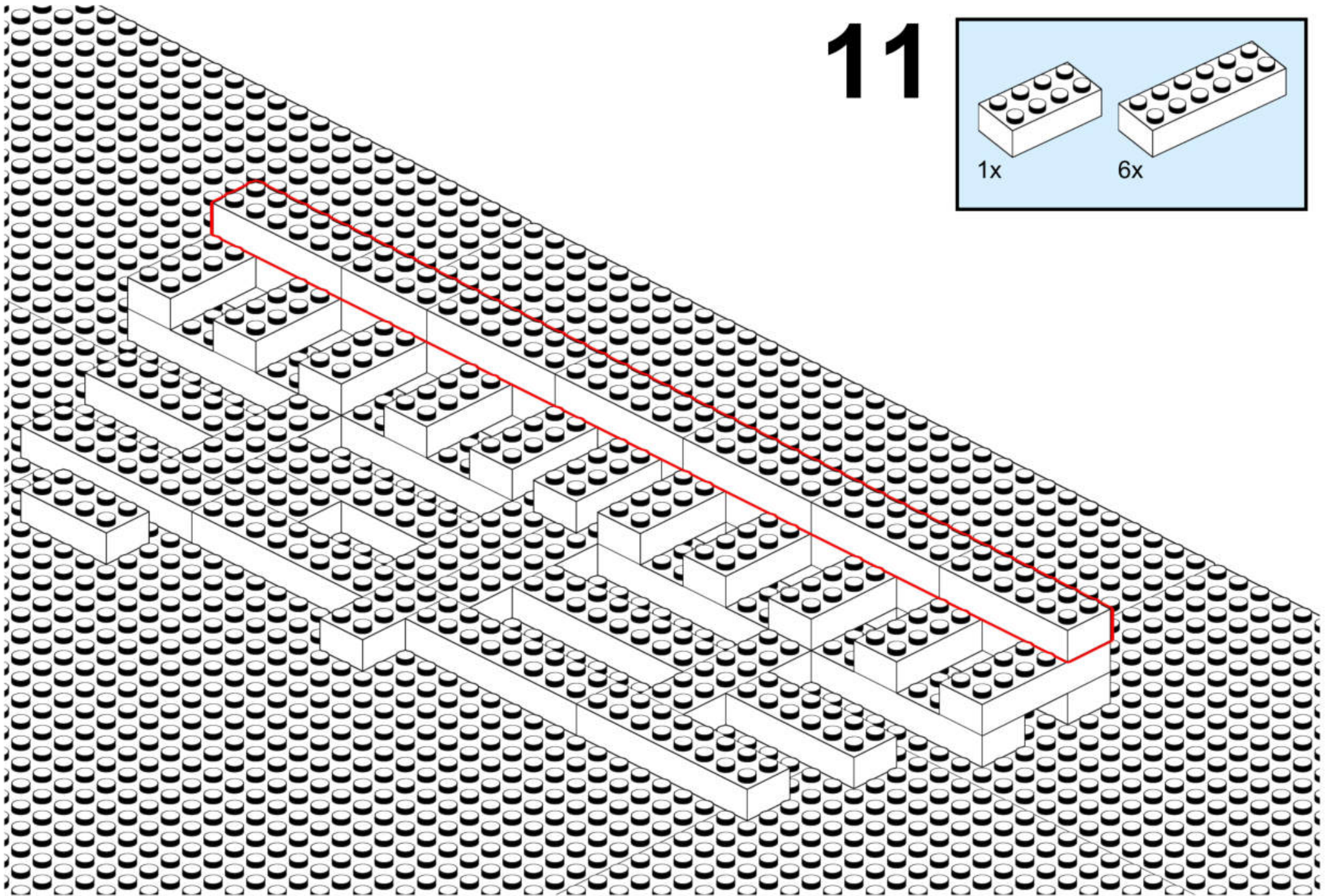
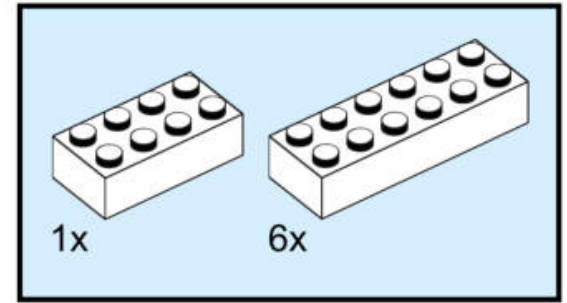



# 12

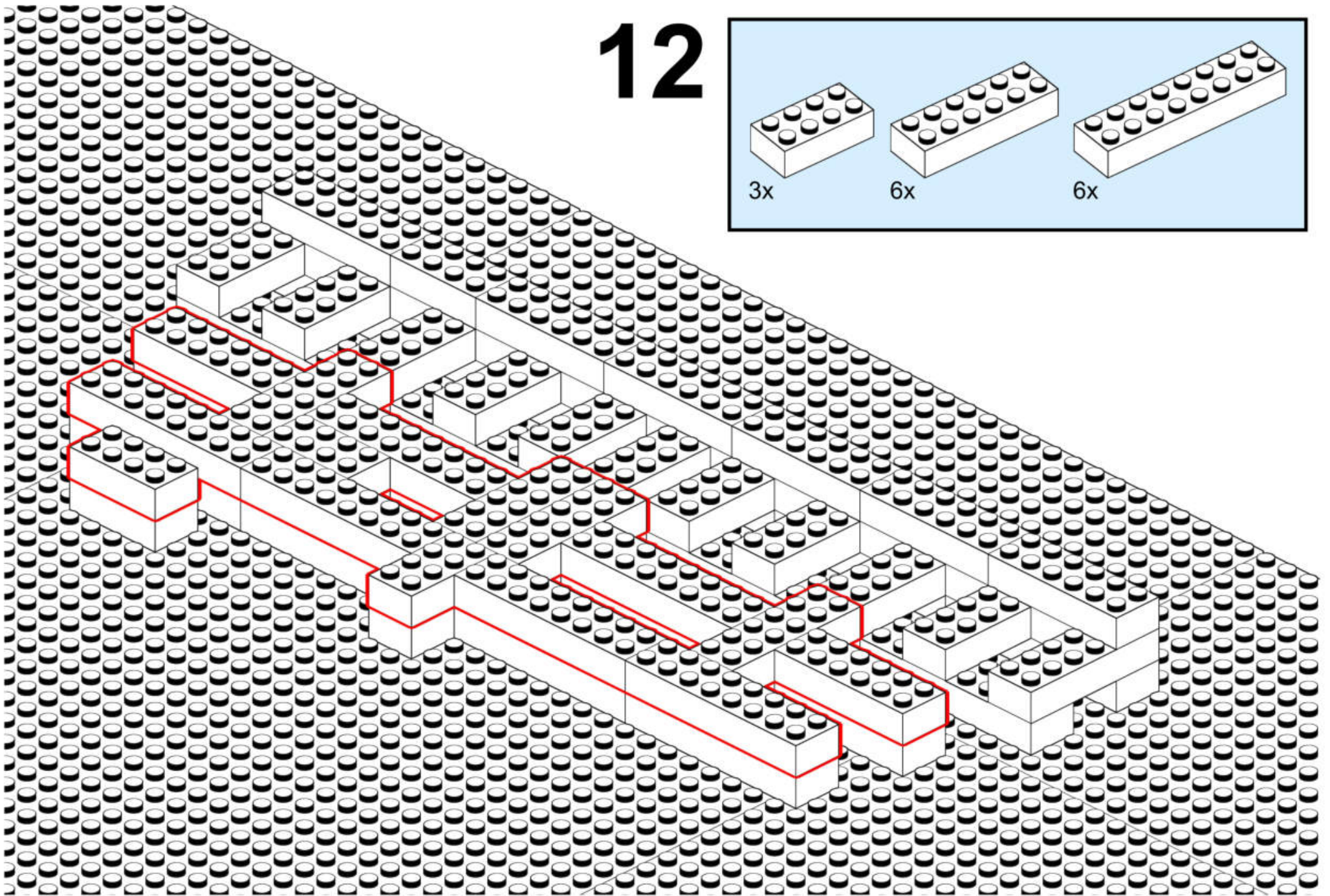
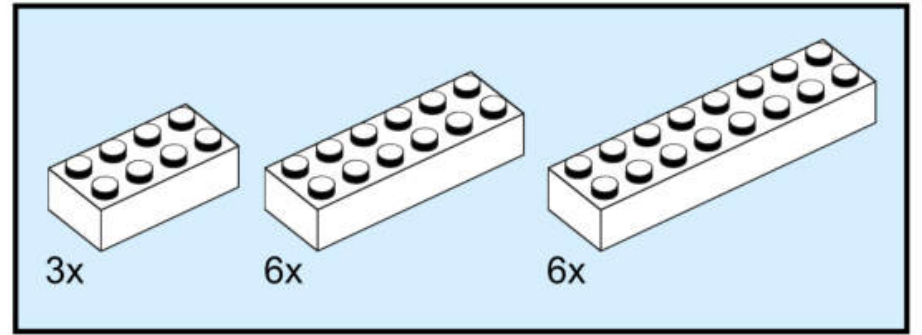



# 13

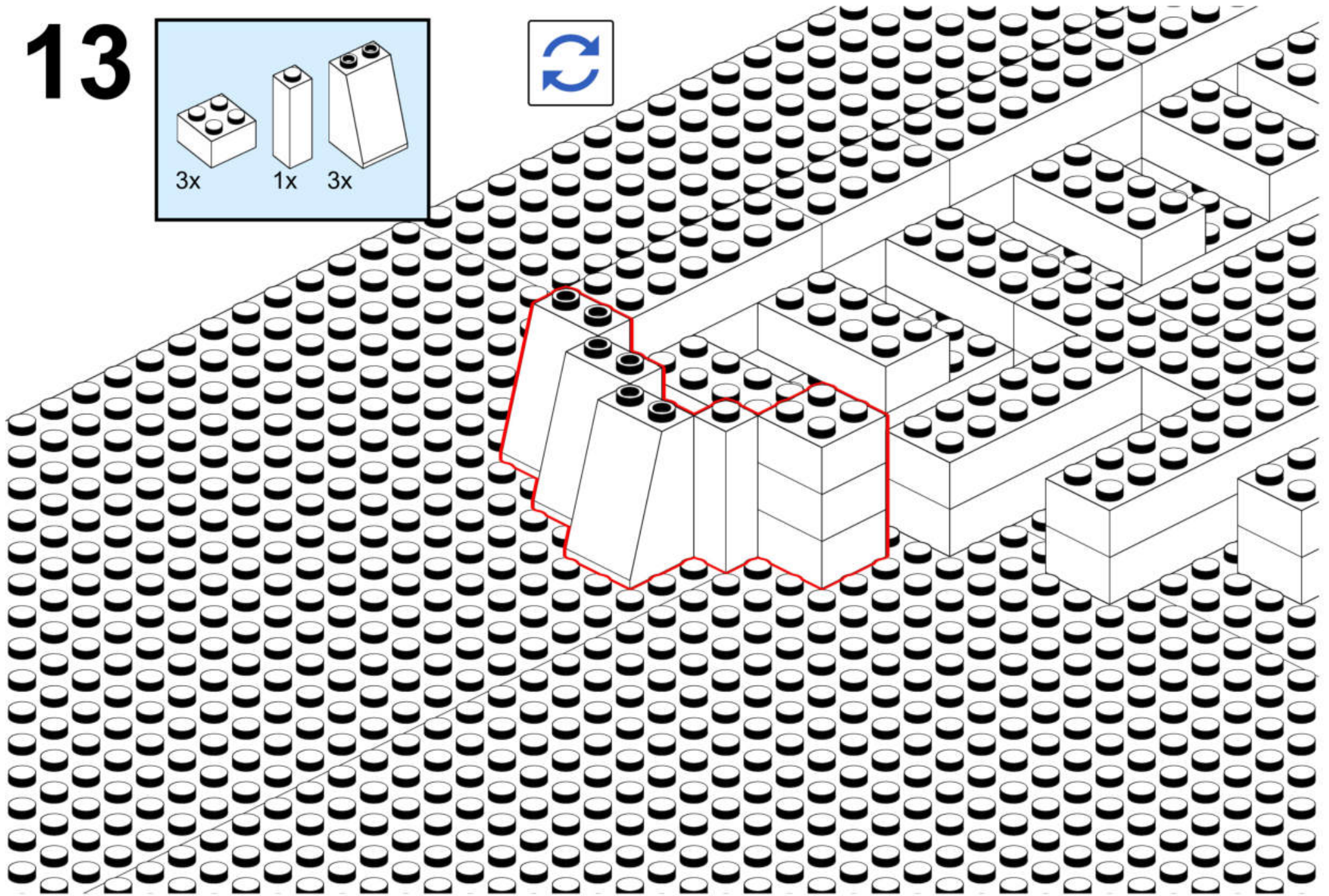
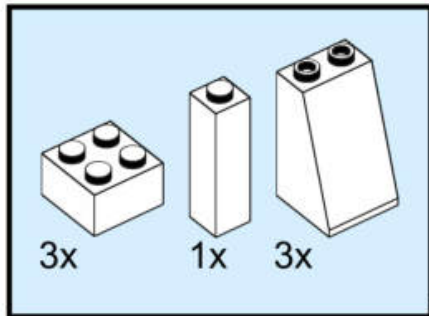



# 14

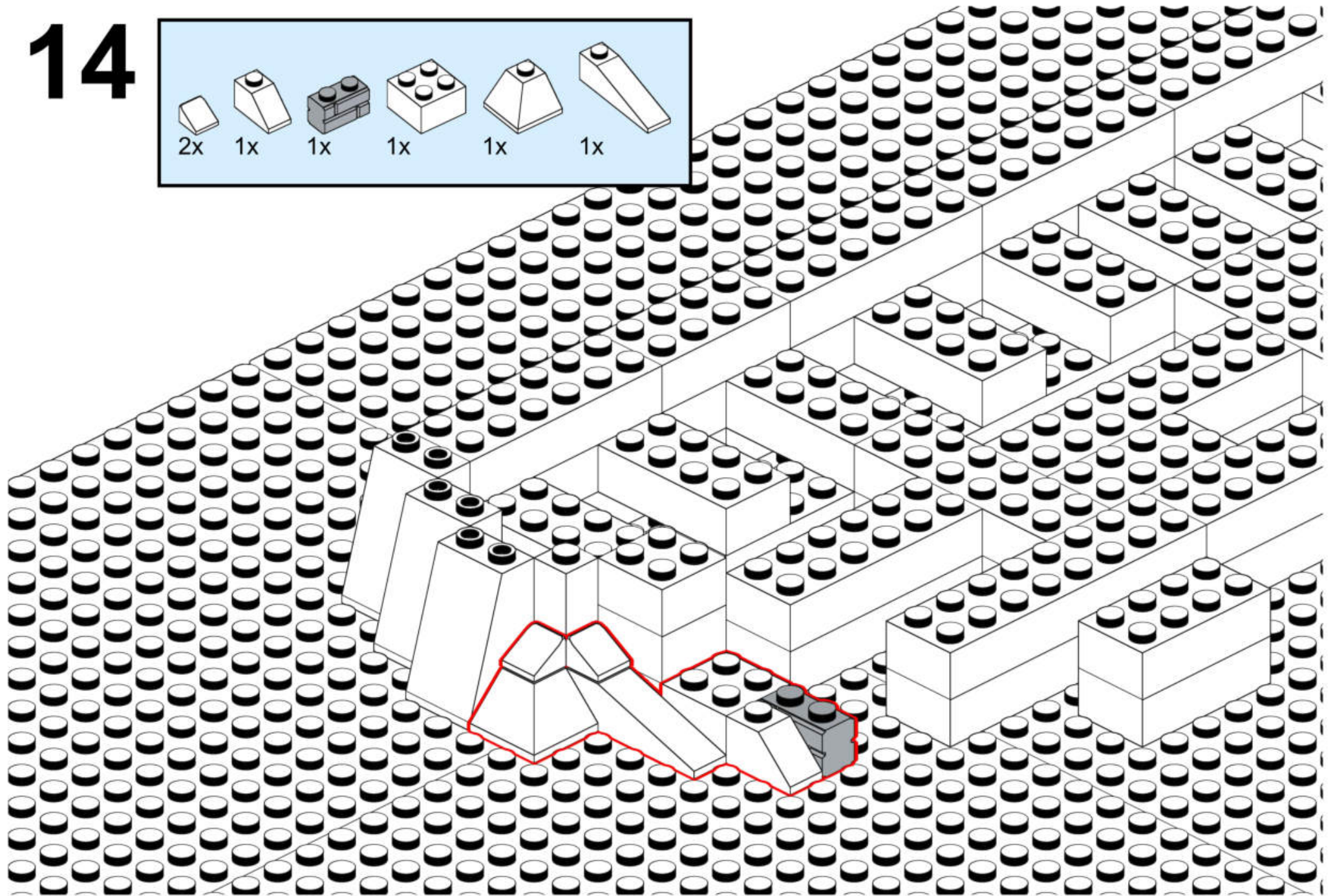
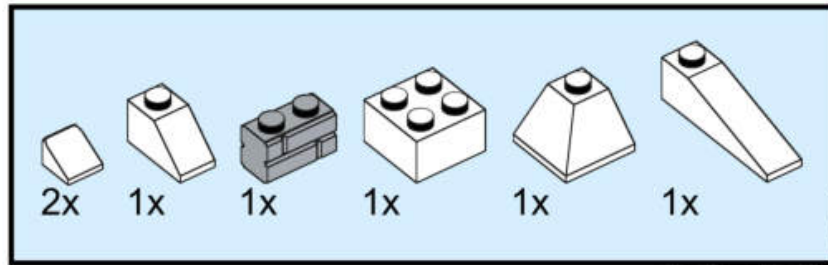



# 15

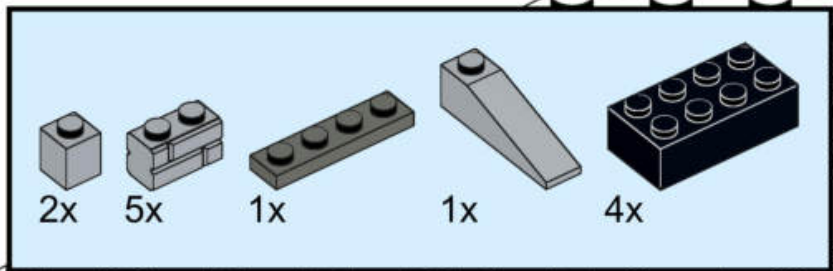

2x 5x 1x 1x 4x

This inset box lists the required parts for step 15: two 1x1 grey bricks, five 1x2 grey bricks, one 1x3 grey brick, one grey wedge, and four 1x4 dark grey bricks.

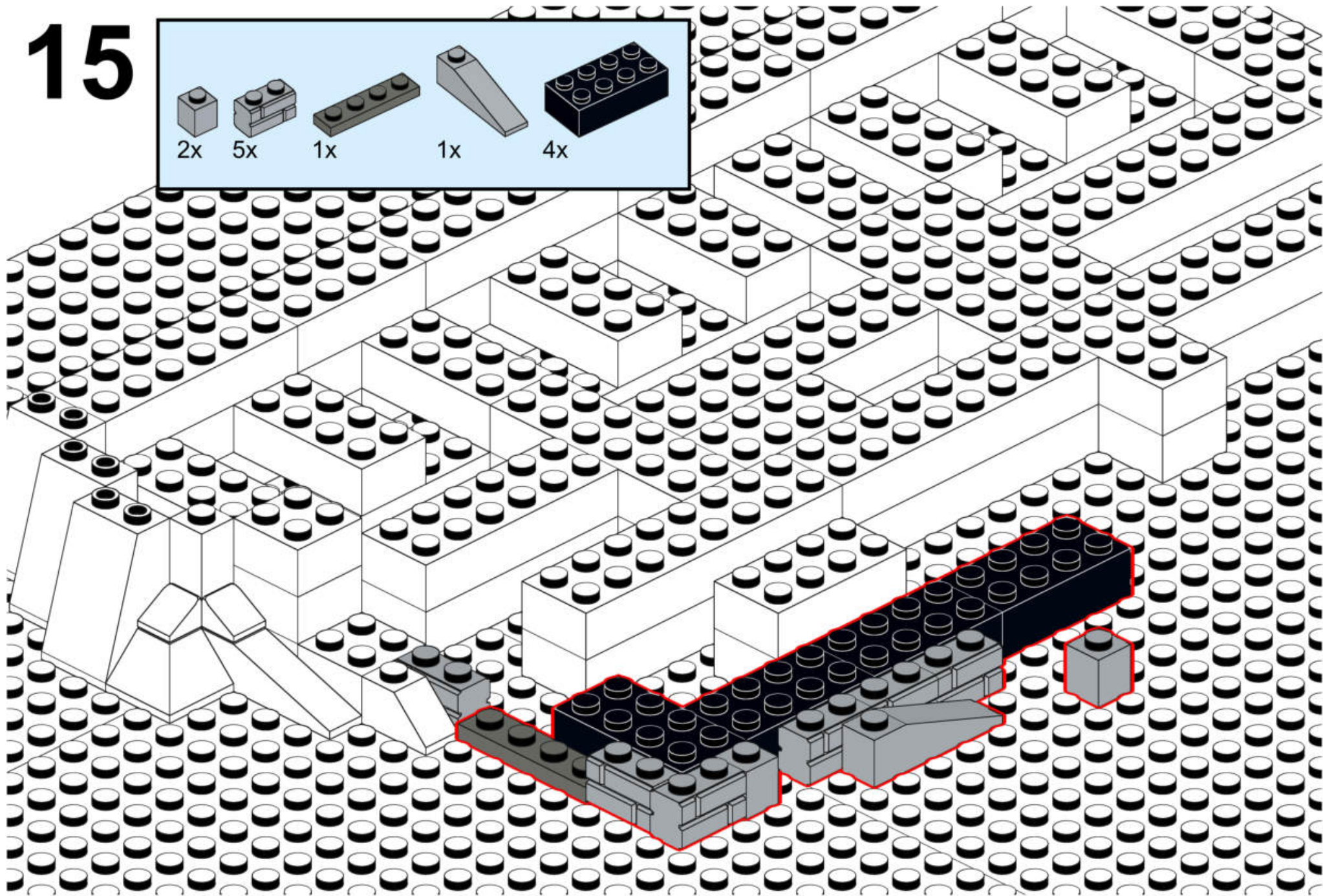



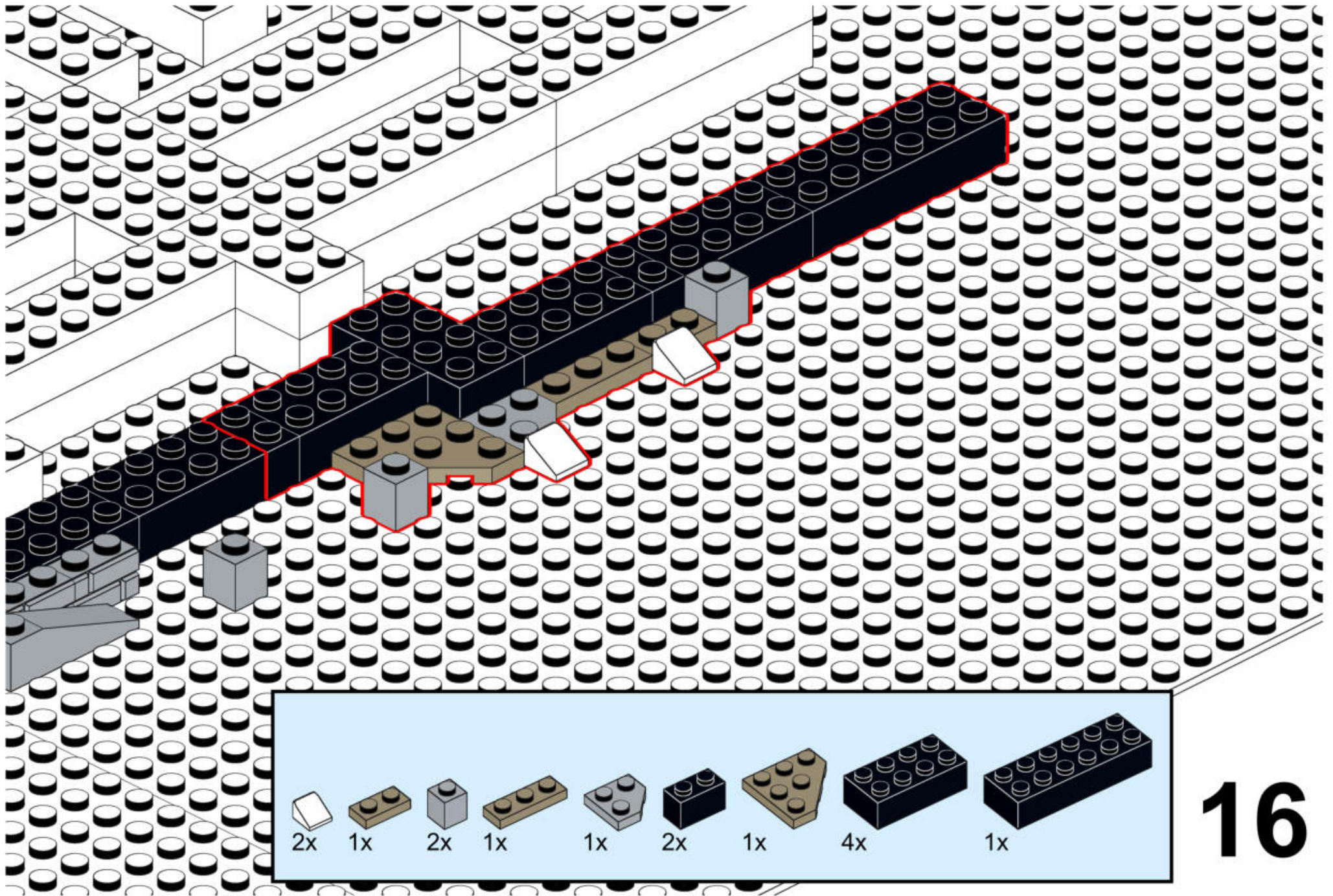

16



# 17

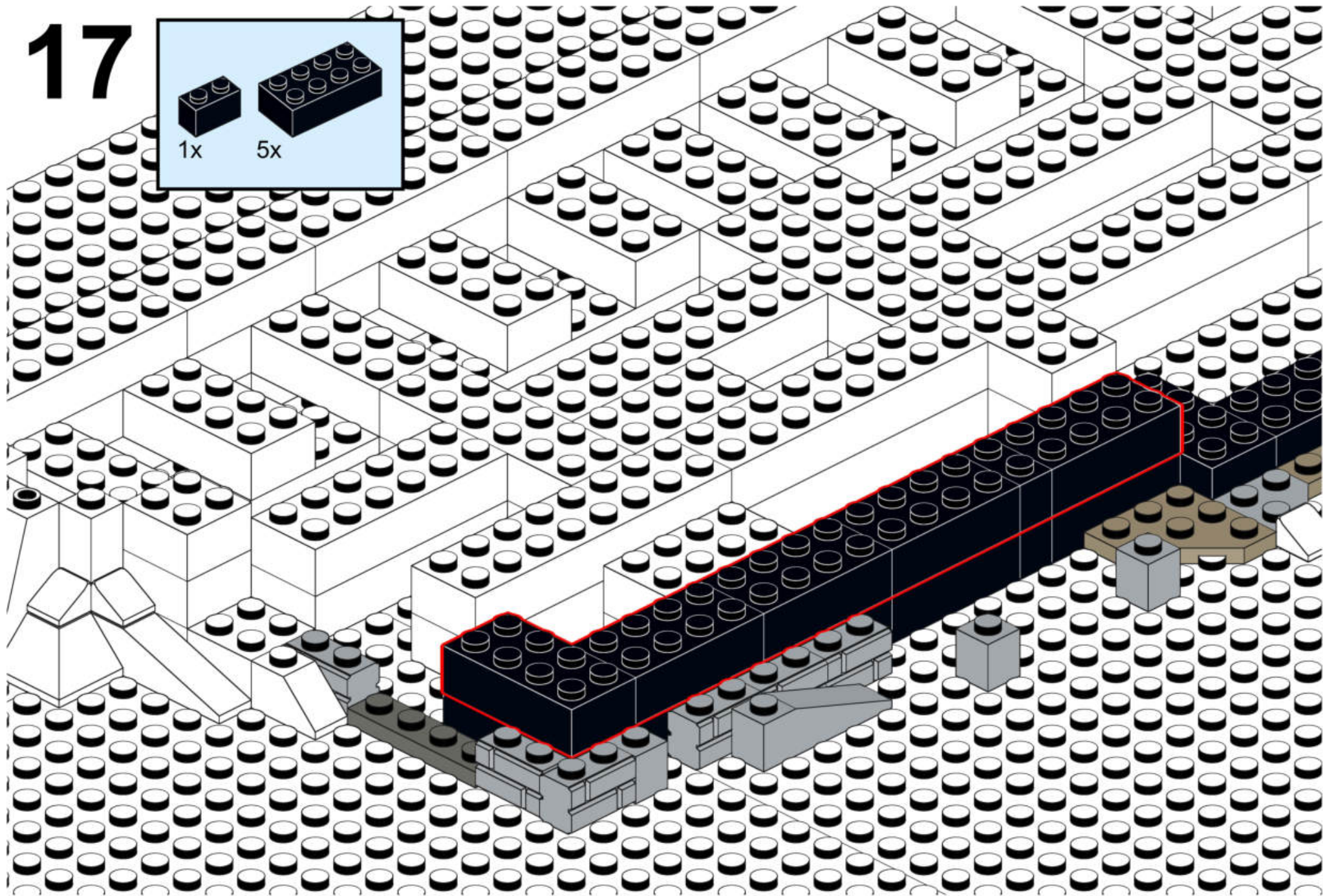
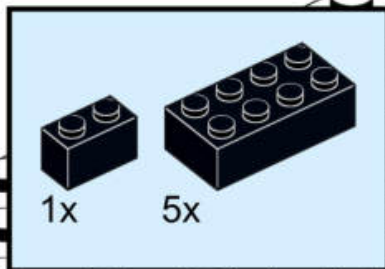



# 18

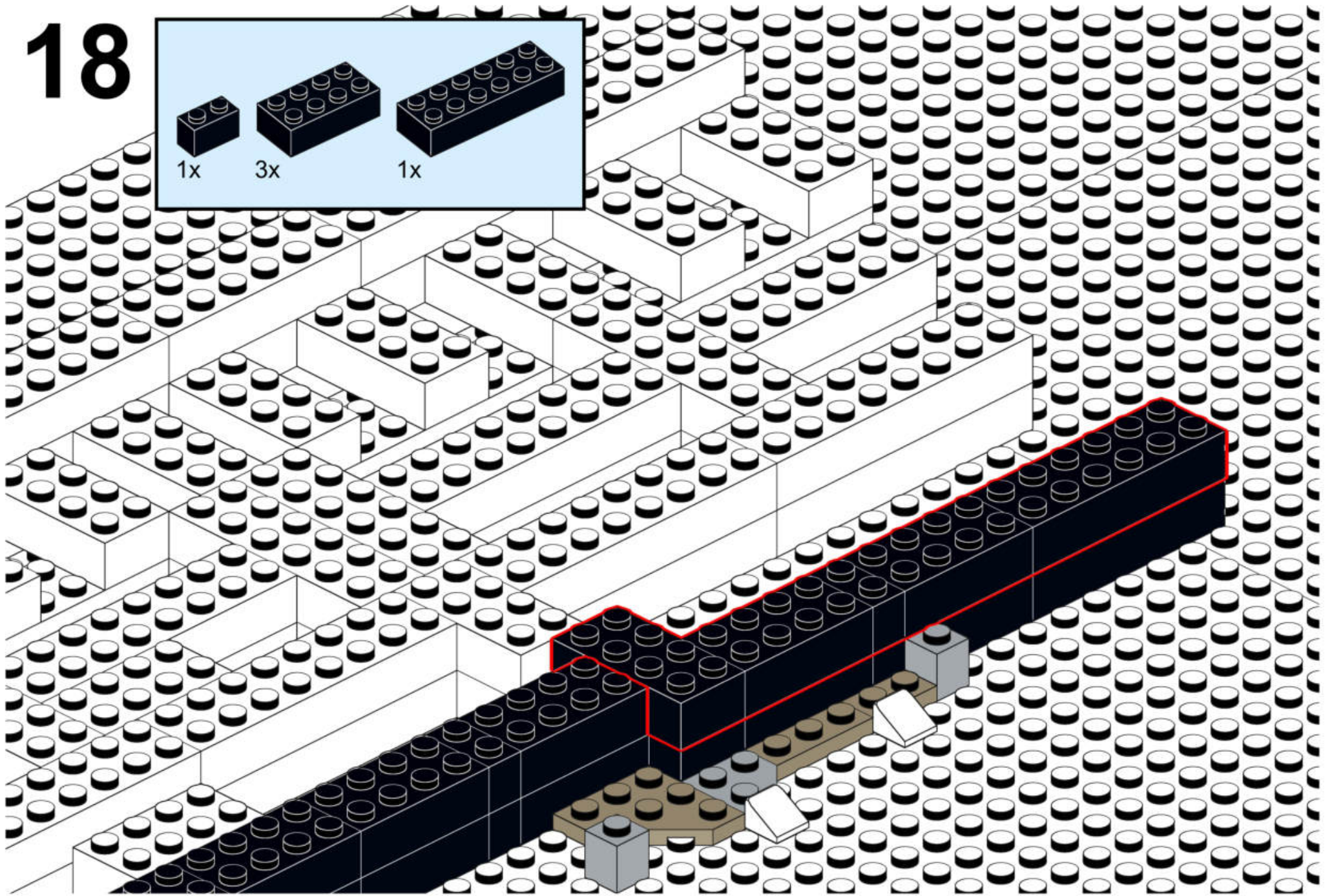
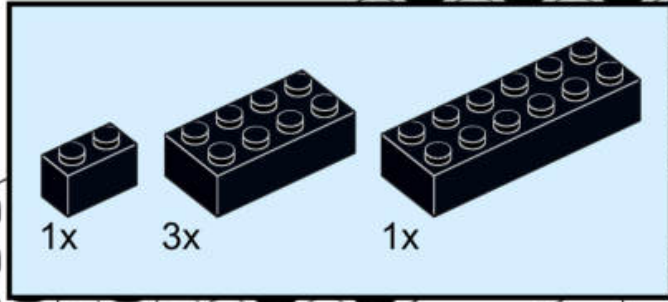



# 19

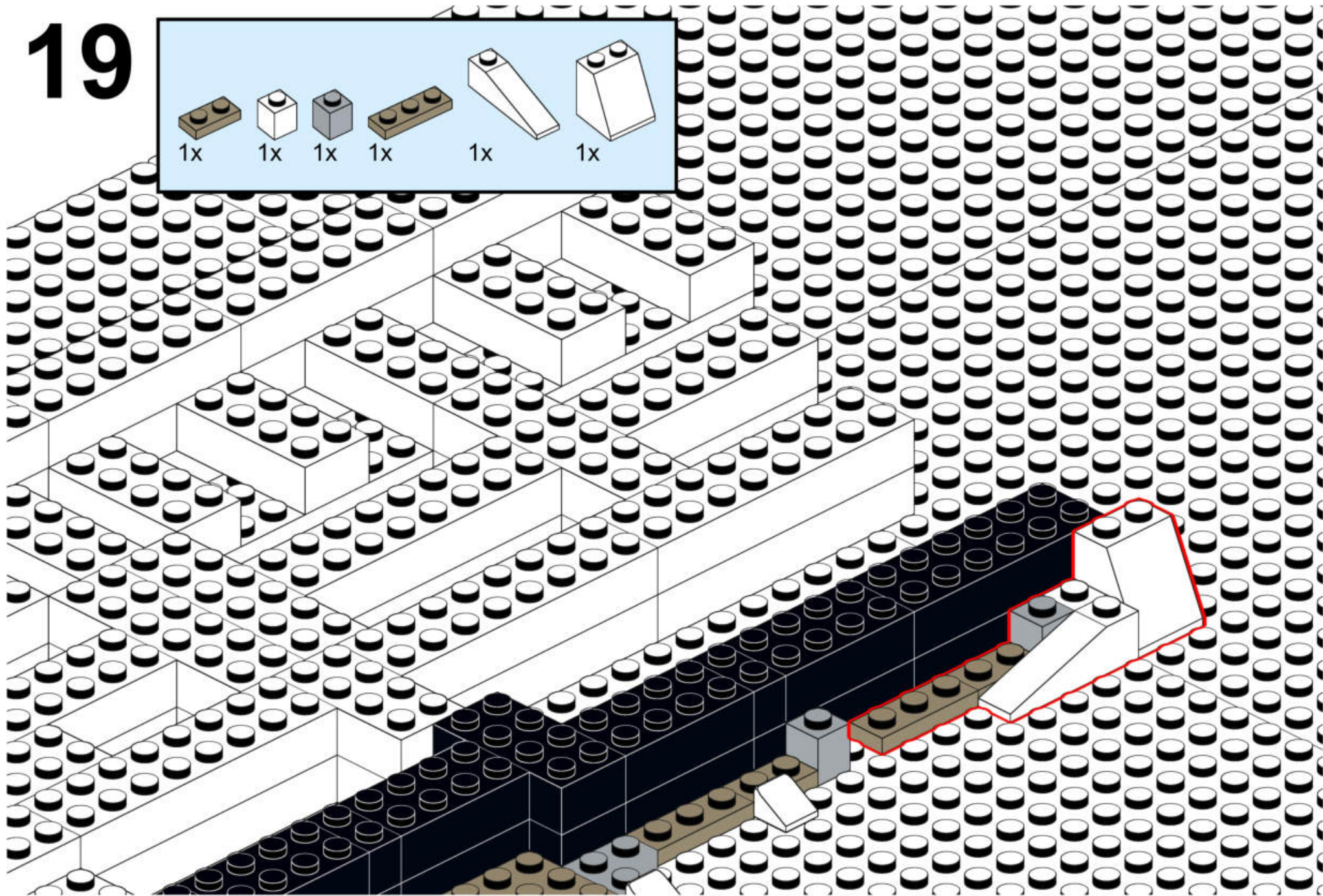
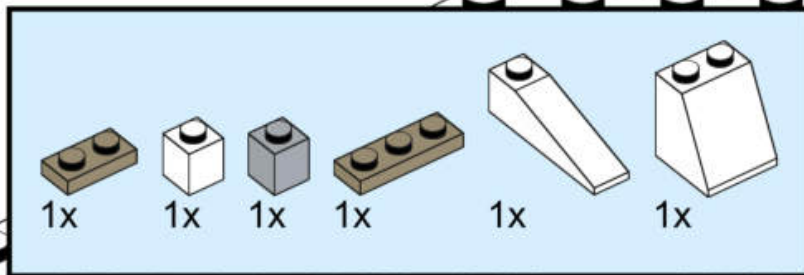



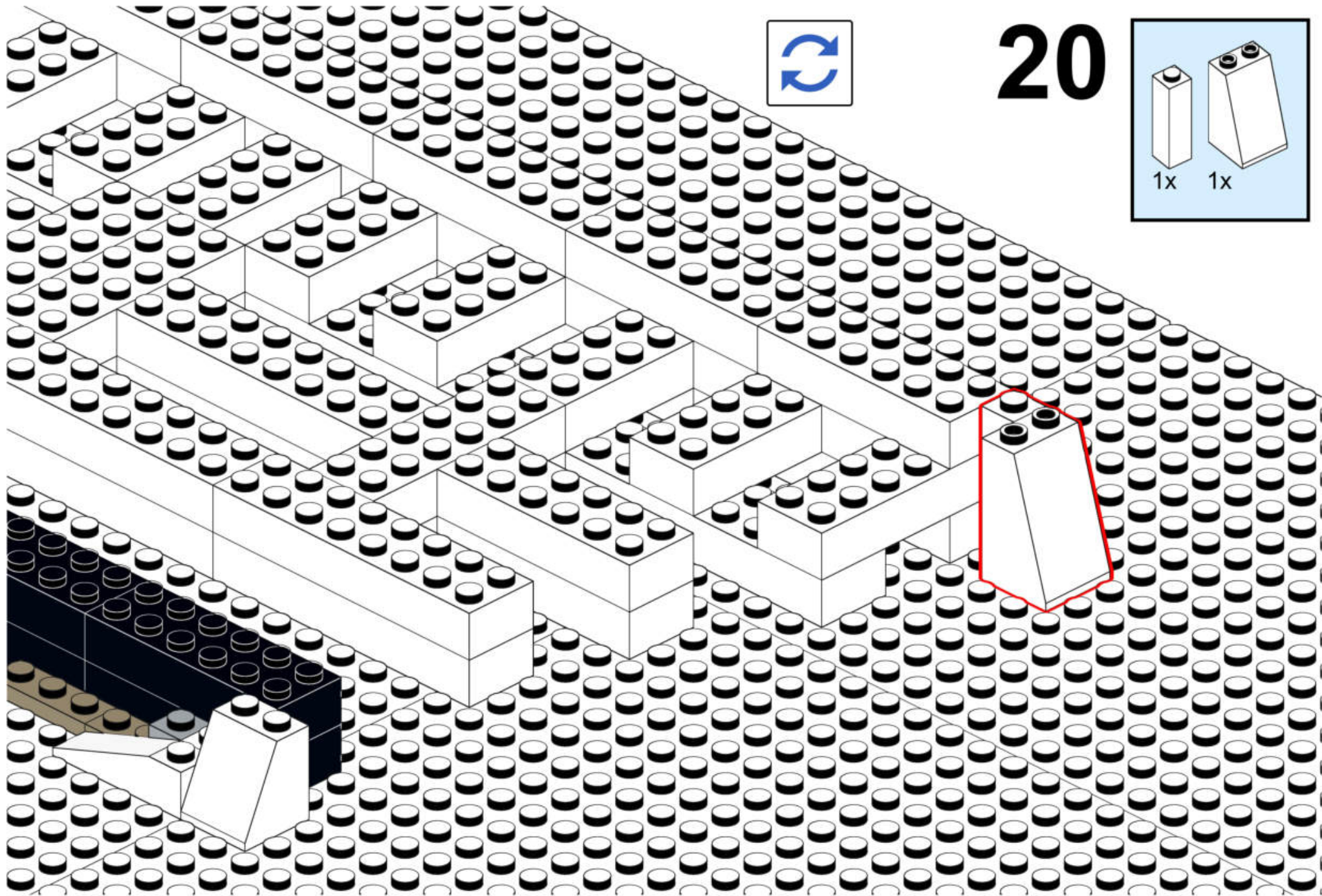



# 21

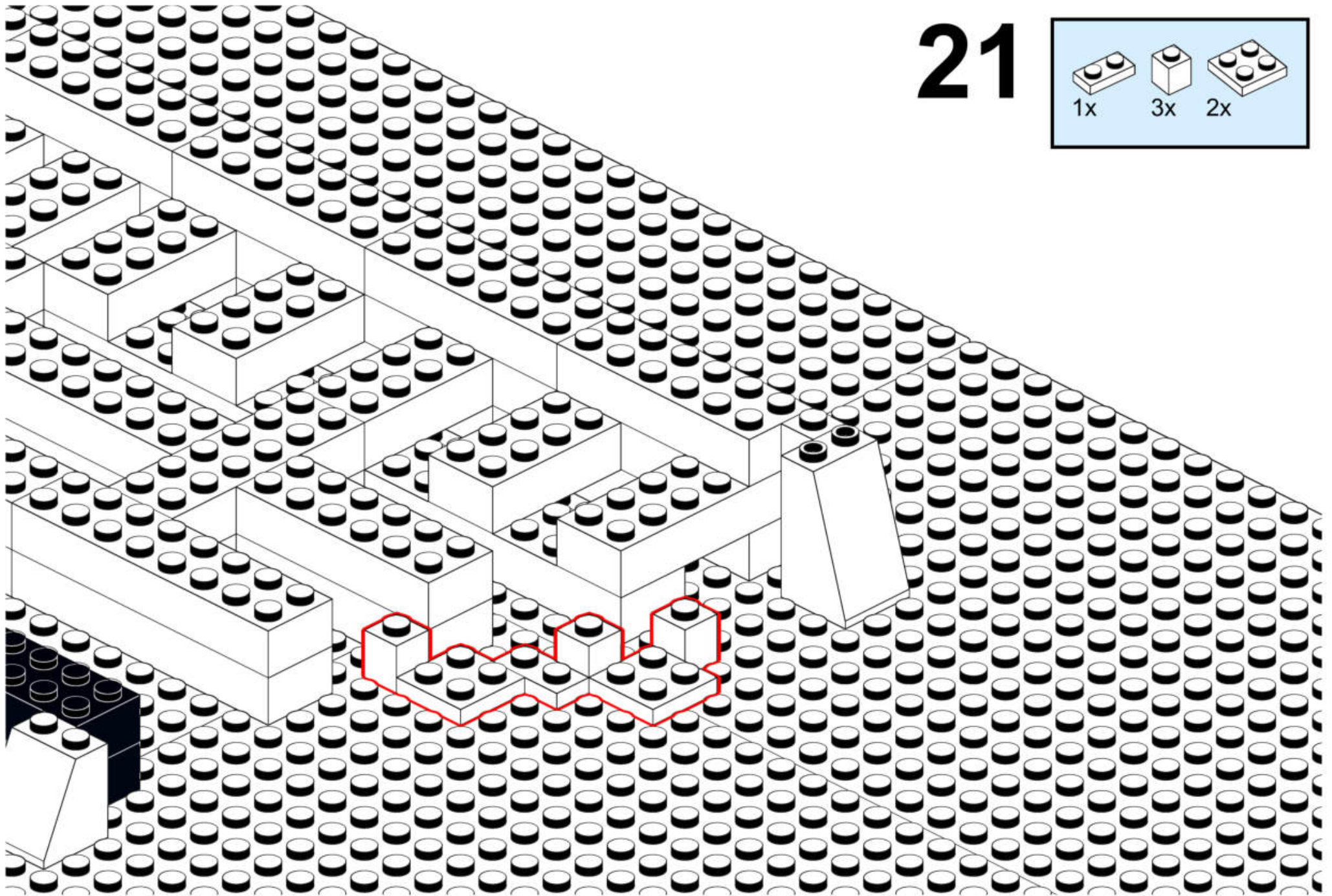
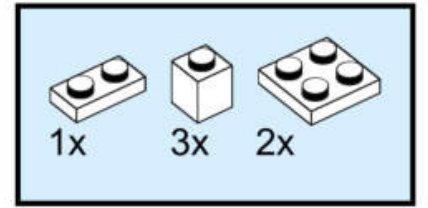



# 22

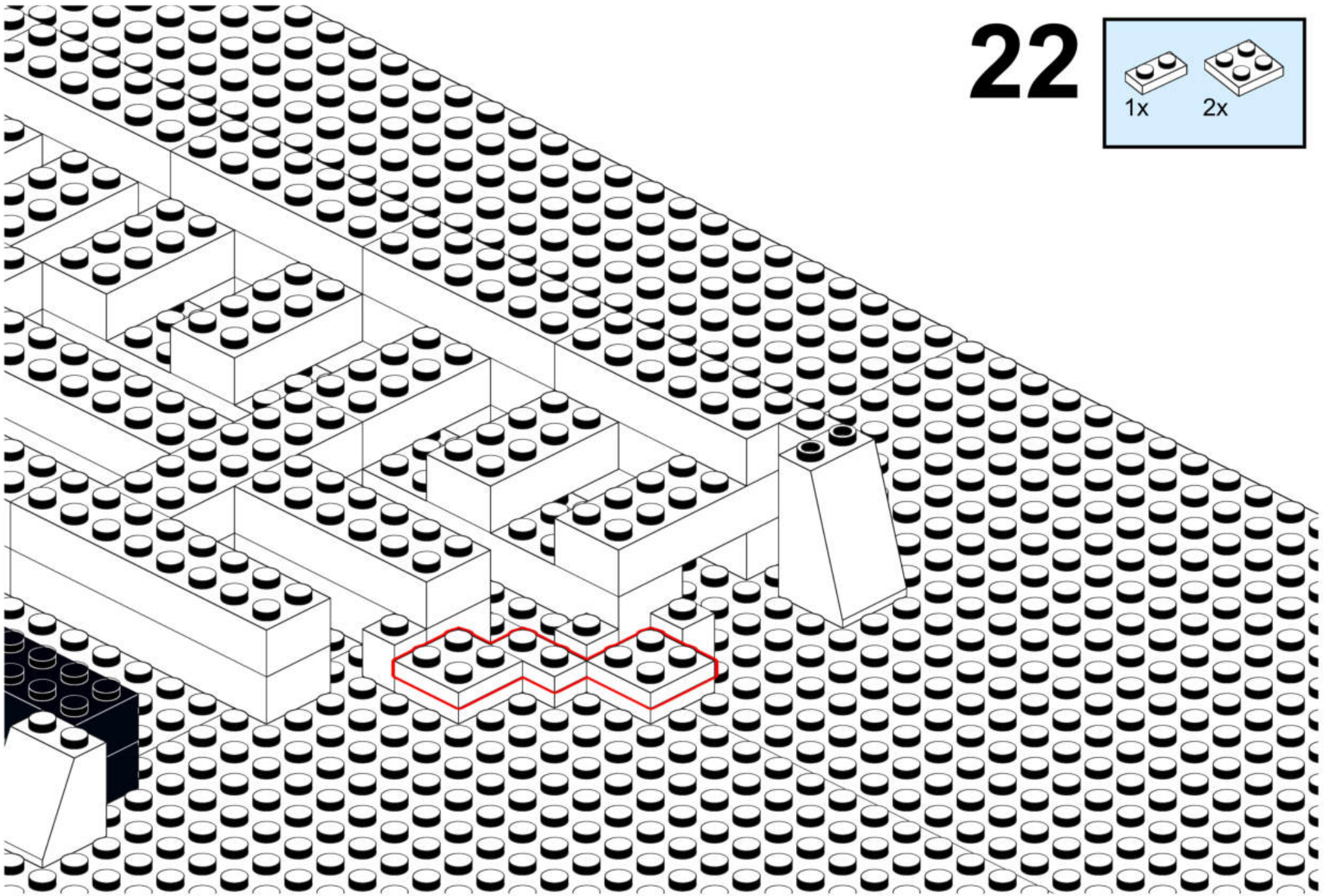
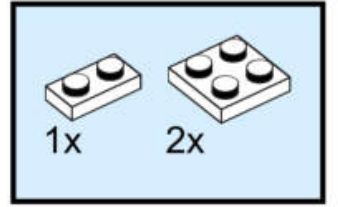



# 23

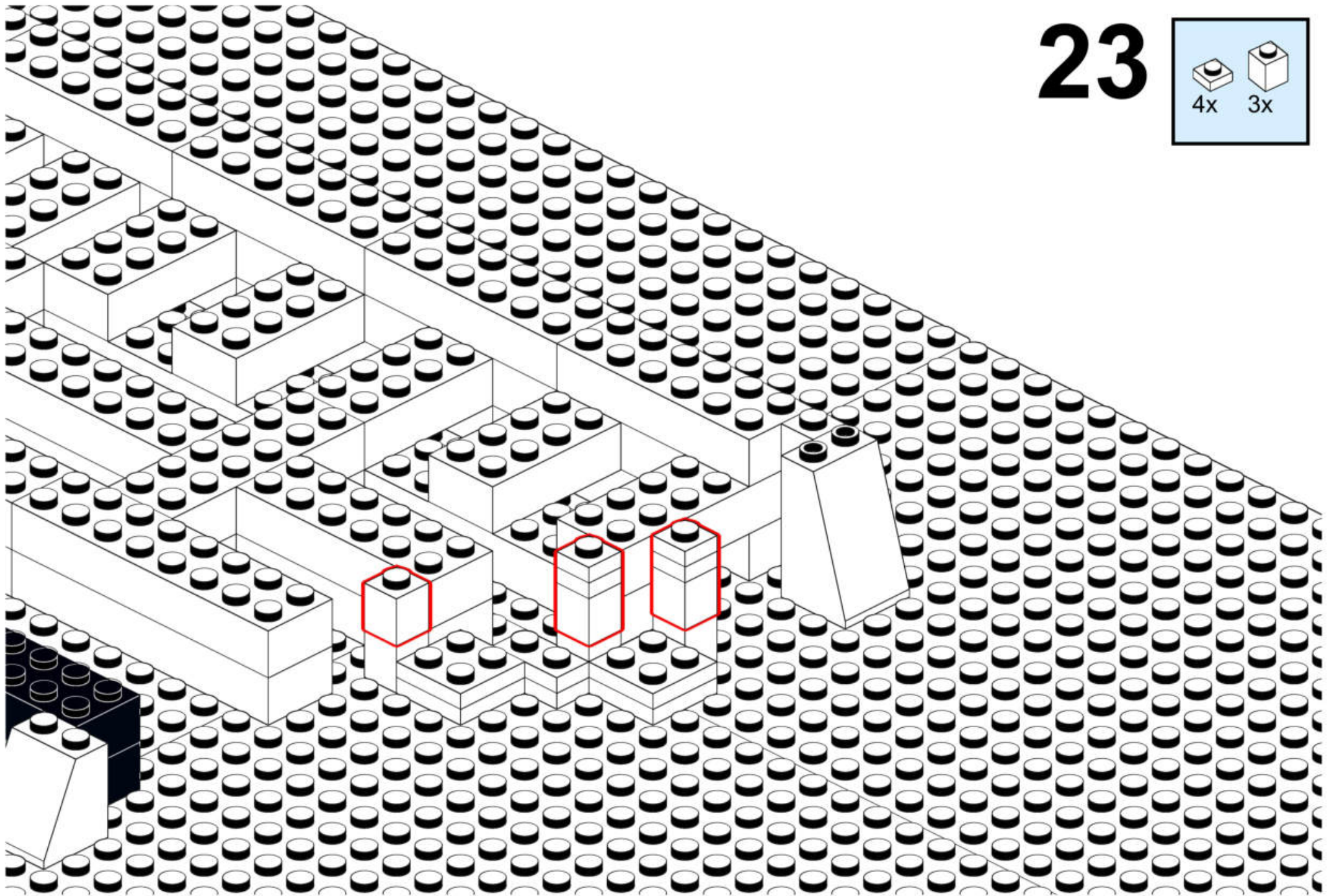
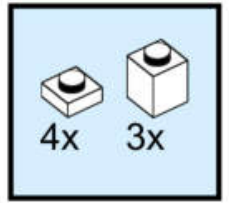



24

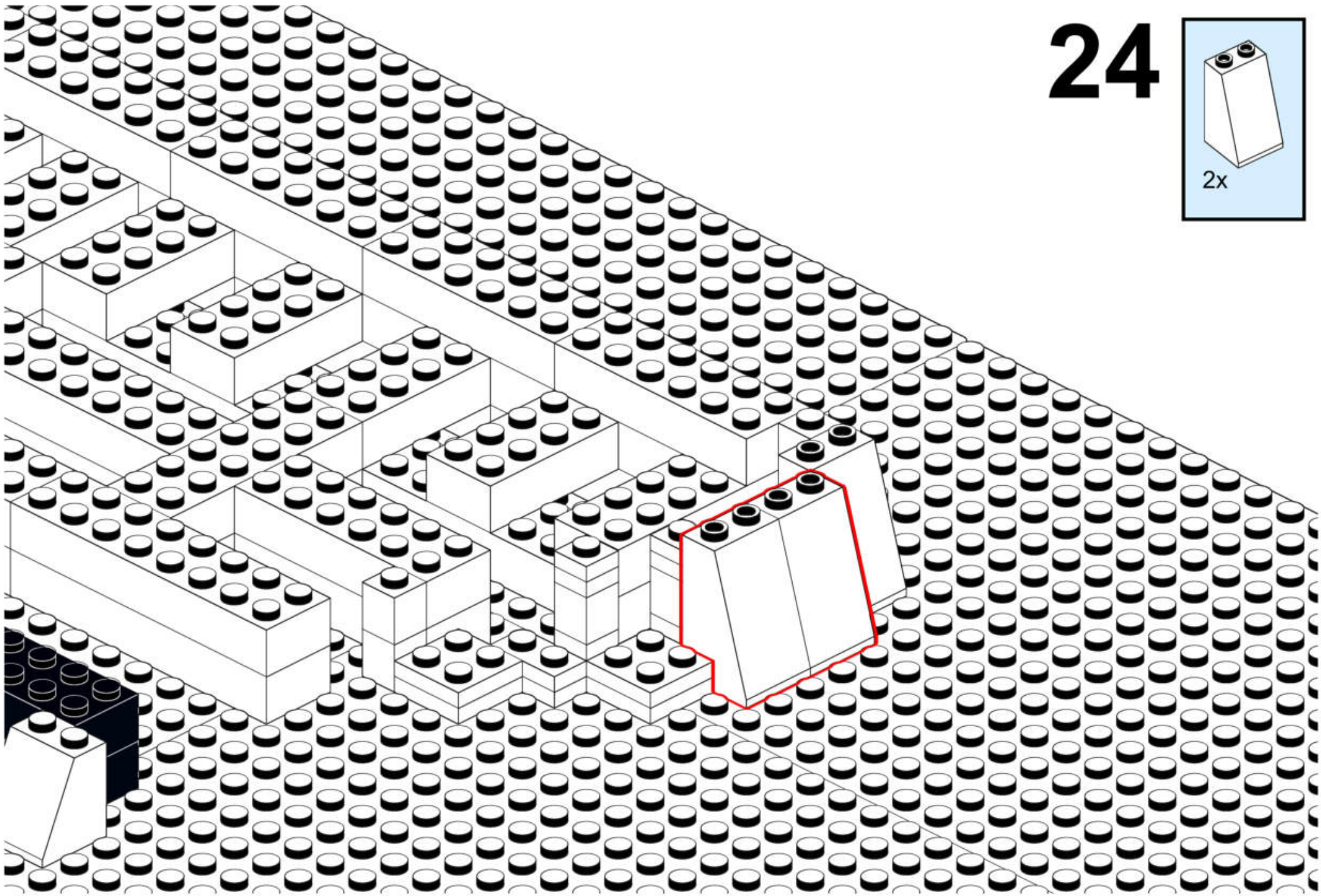
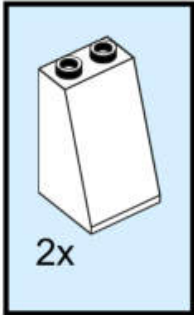



# 25

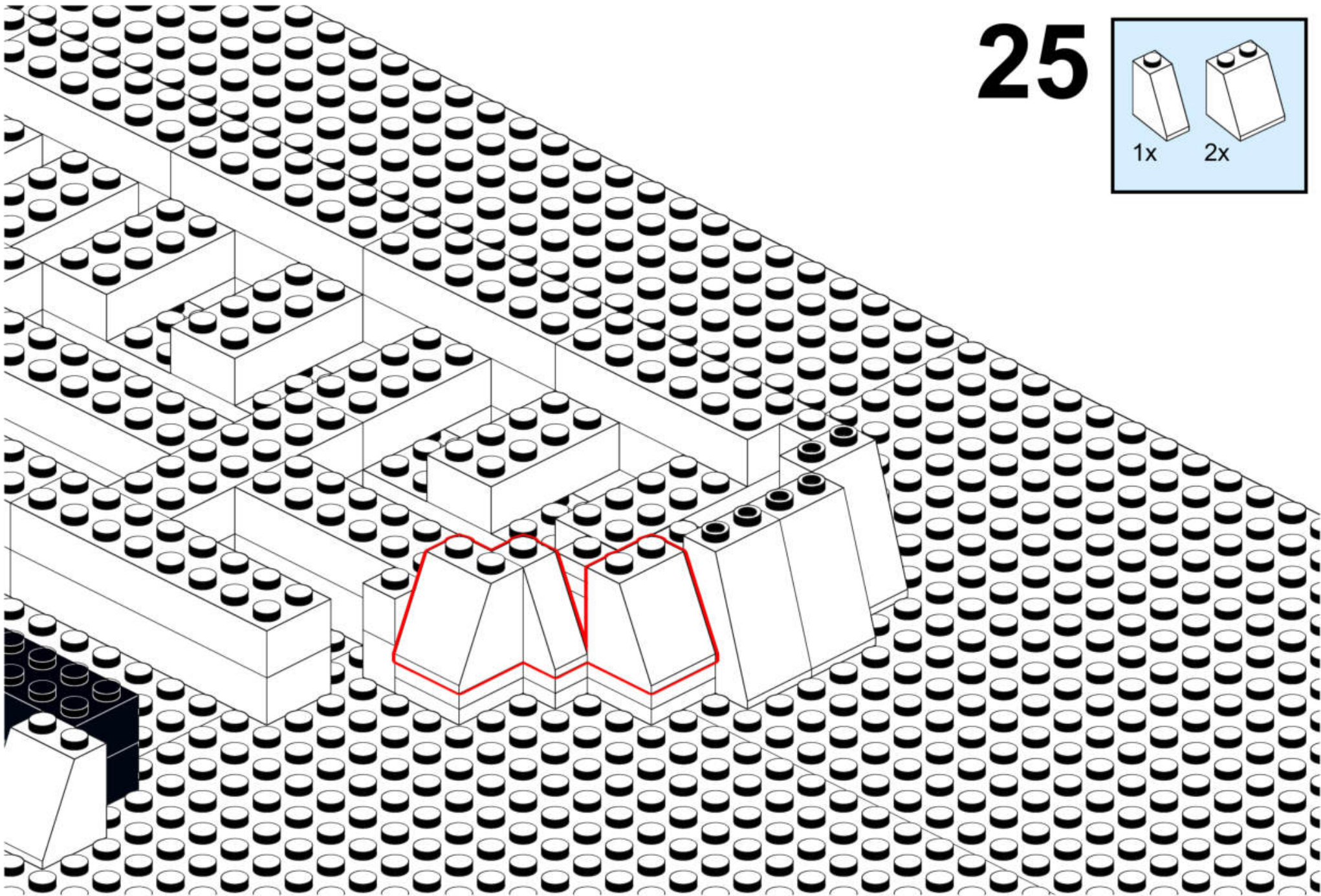
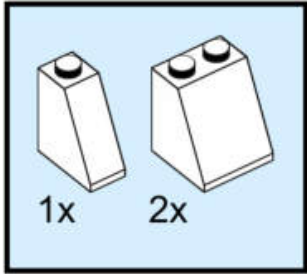



# 26

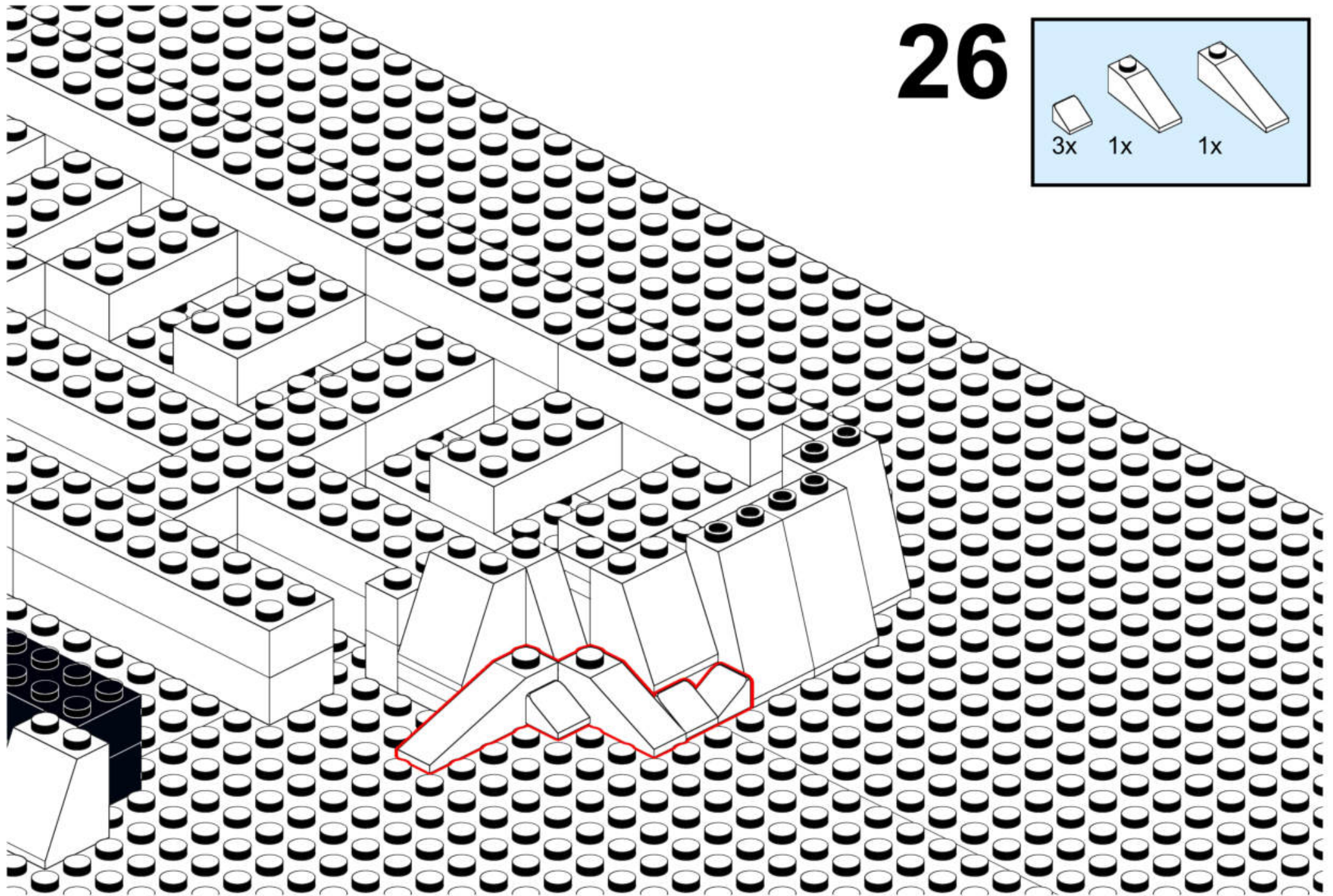
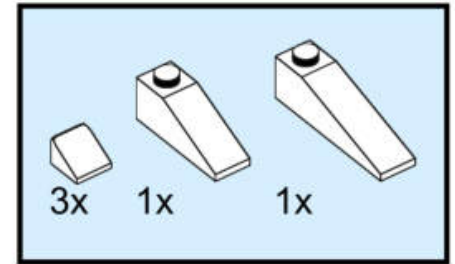



# 27

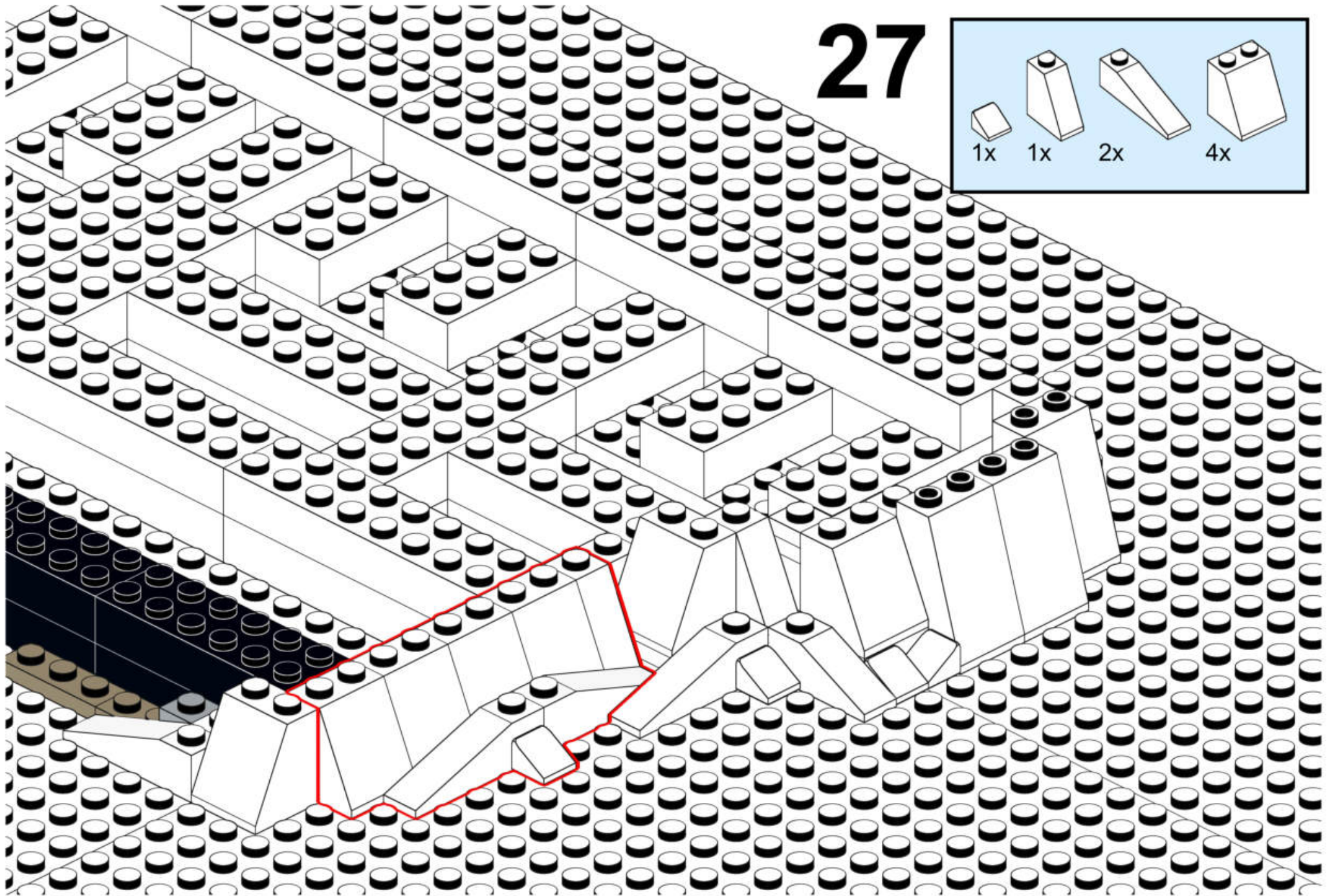
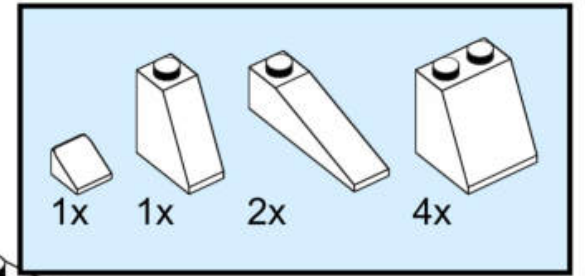



# 28

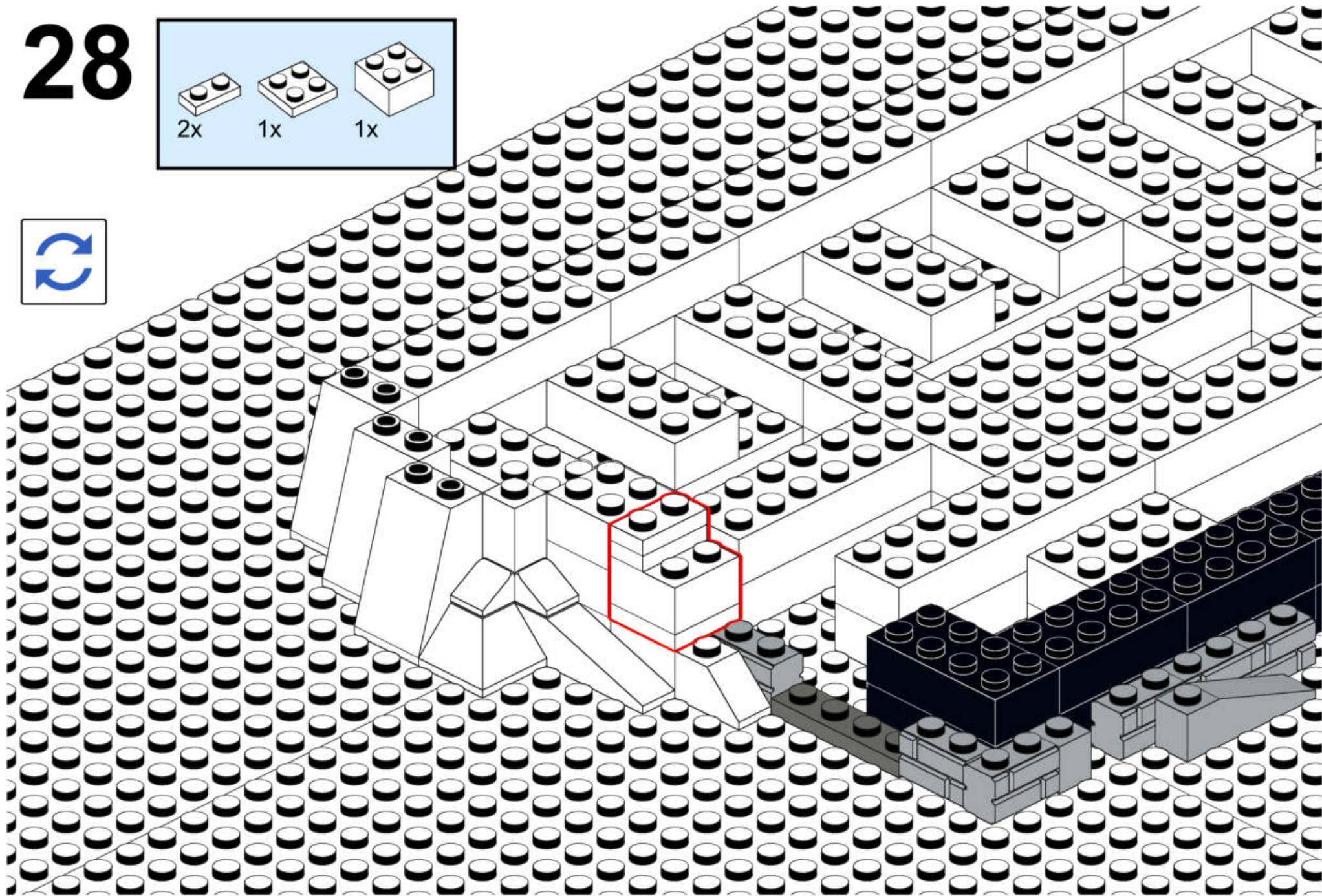
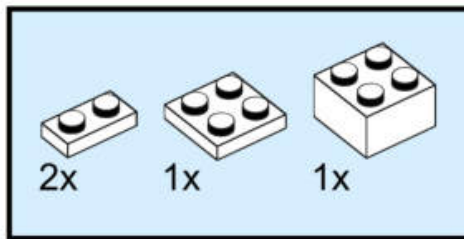



# 29

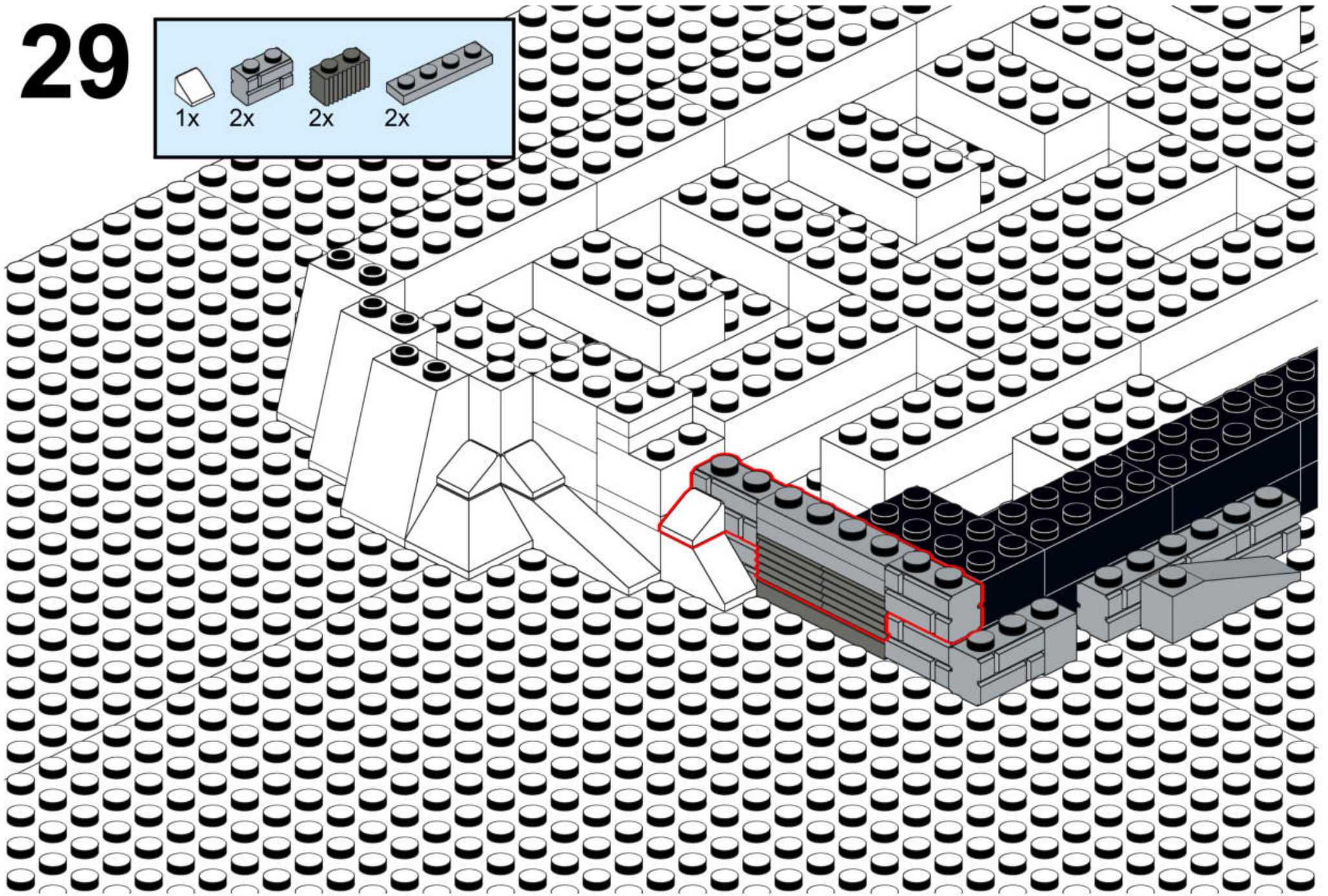
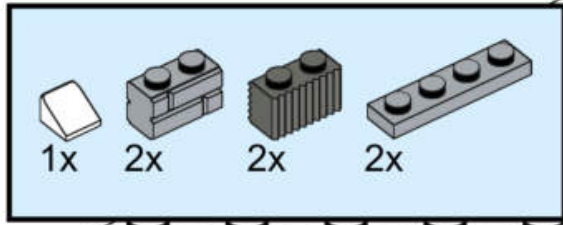





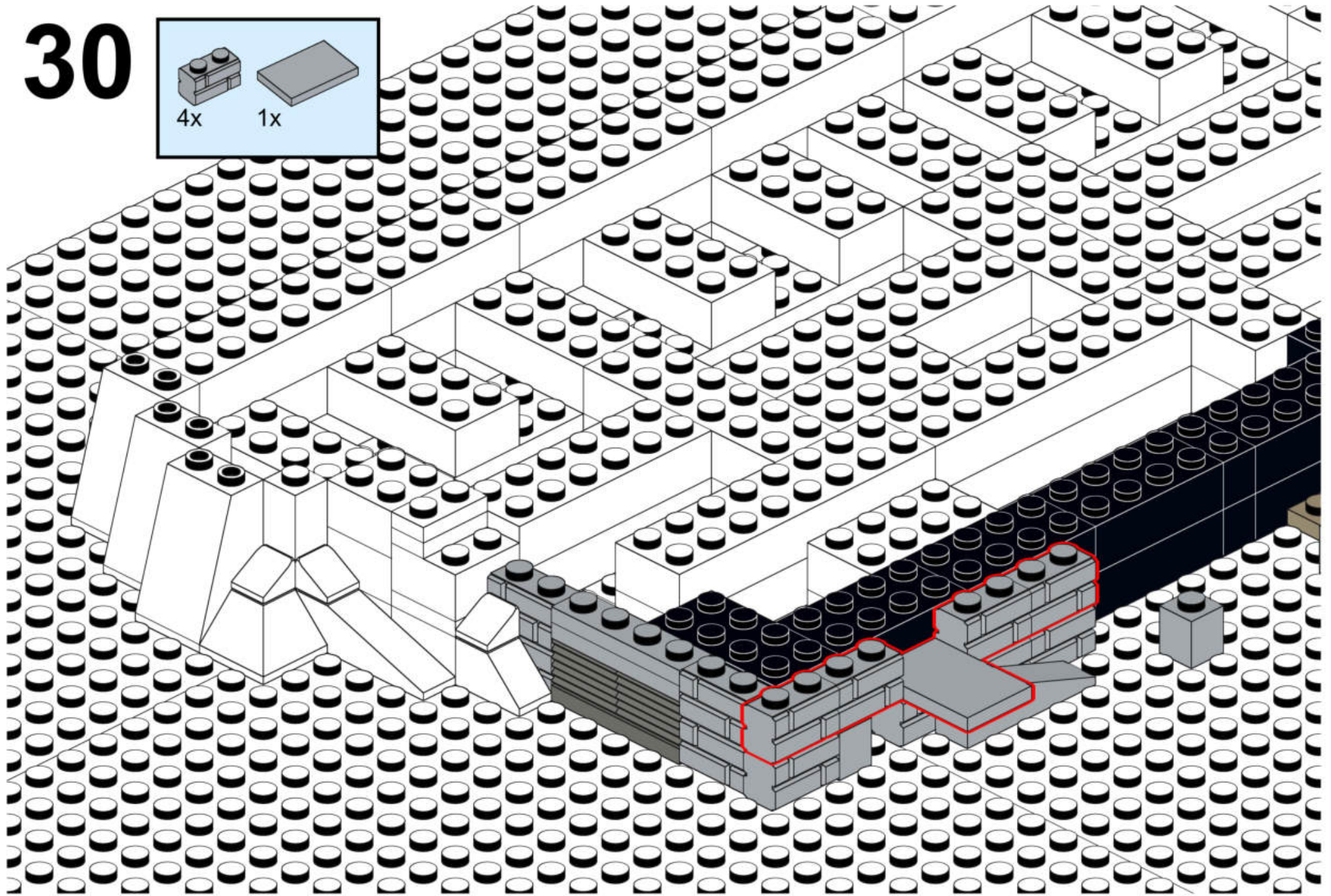
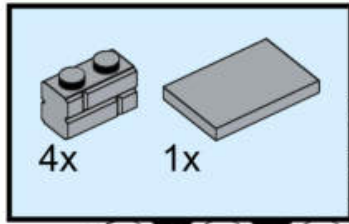

# 30





# 31

			
3x	1x	1x	1x





# 32

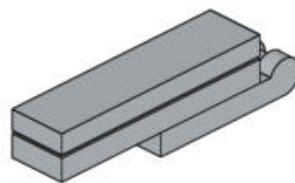
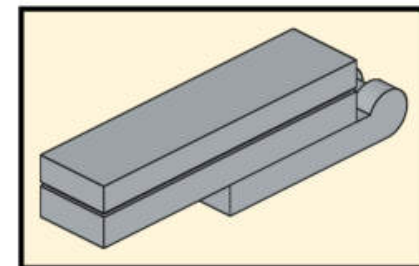
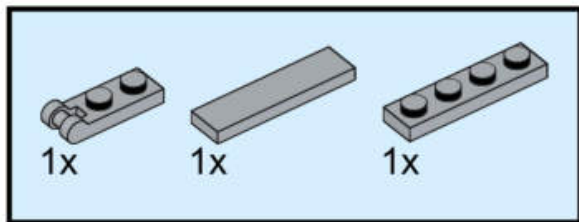



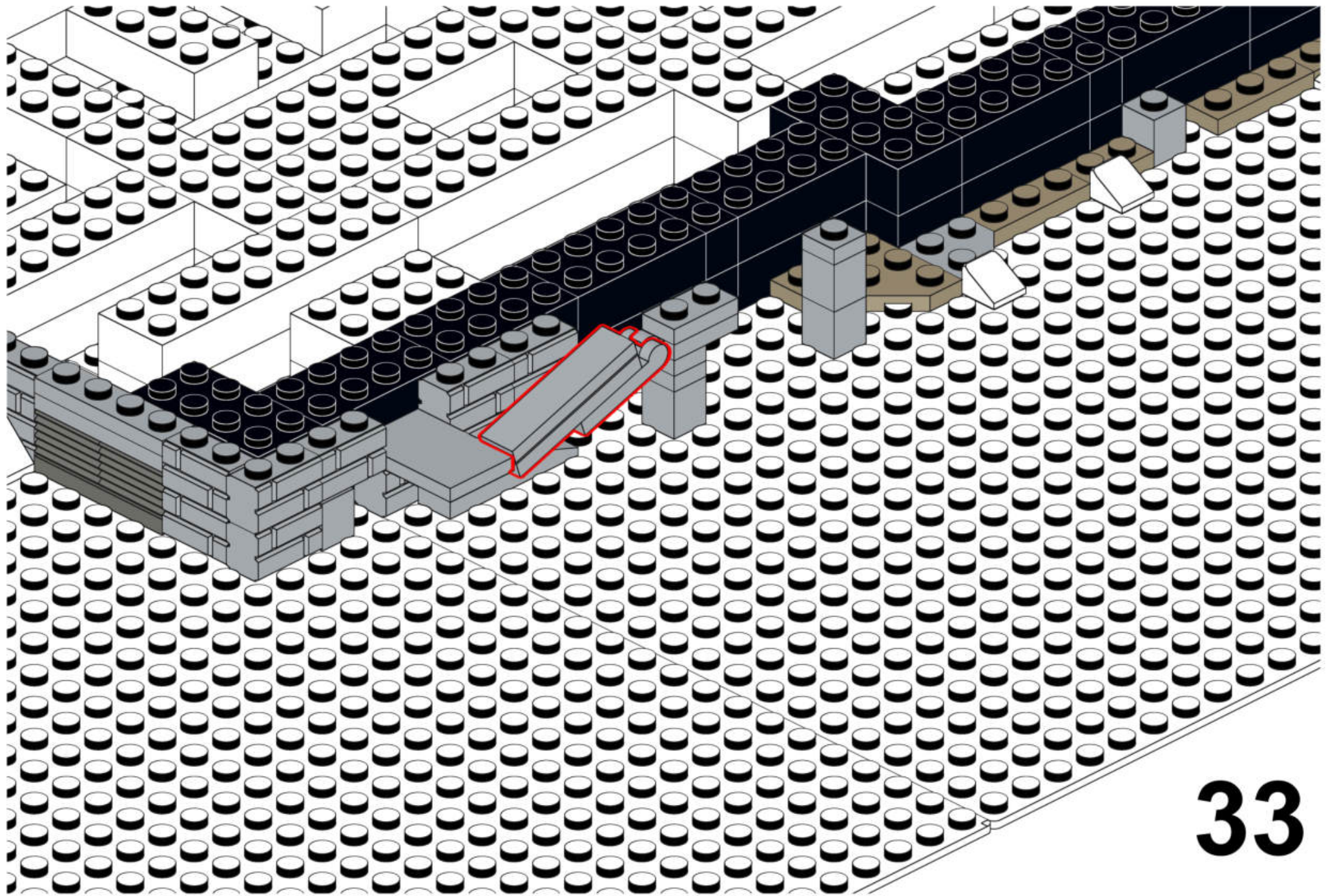



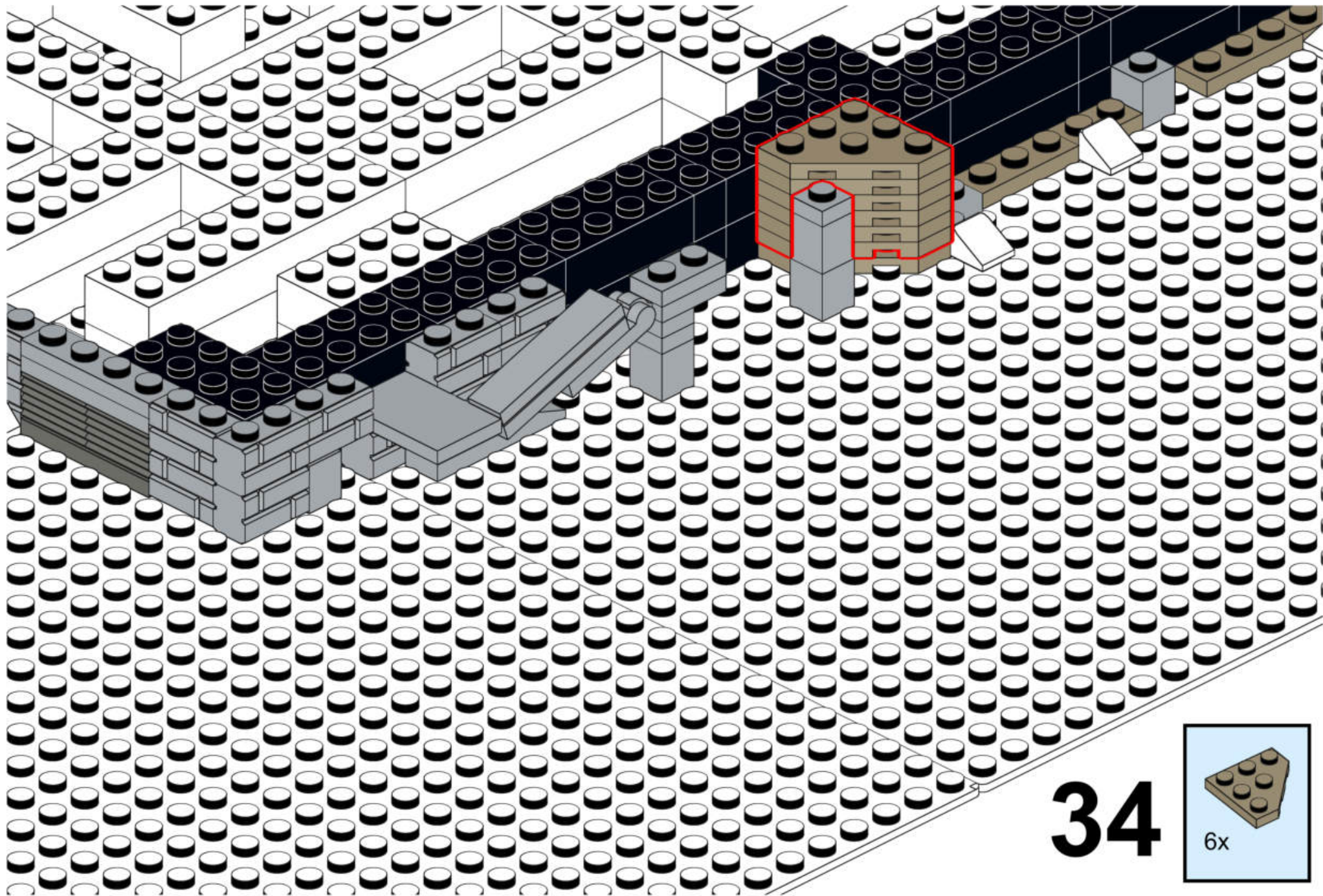



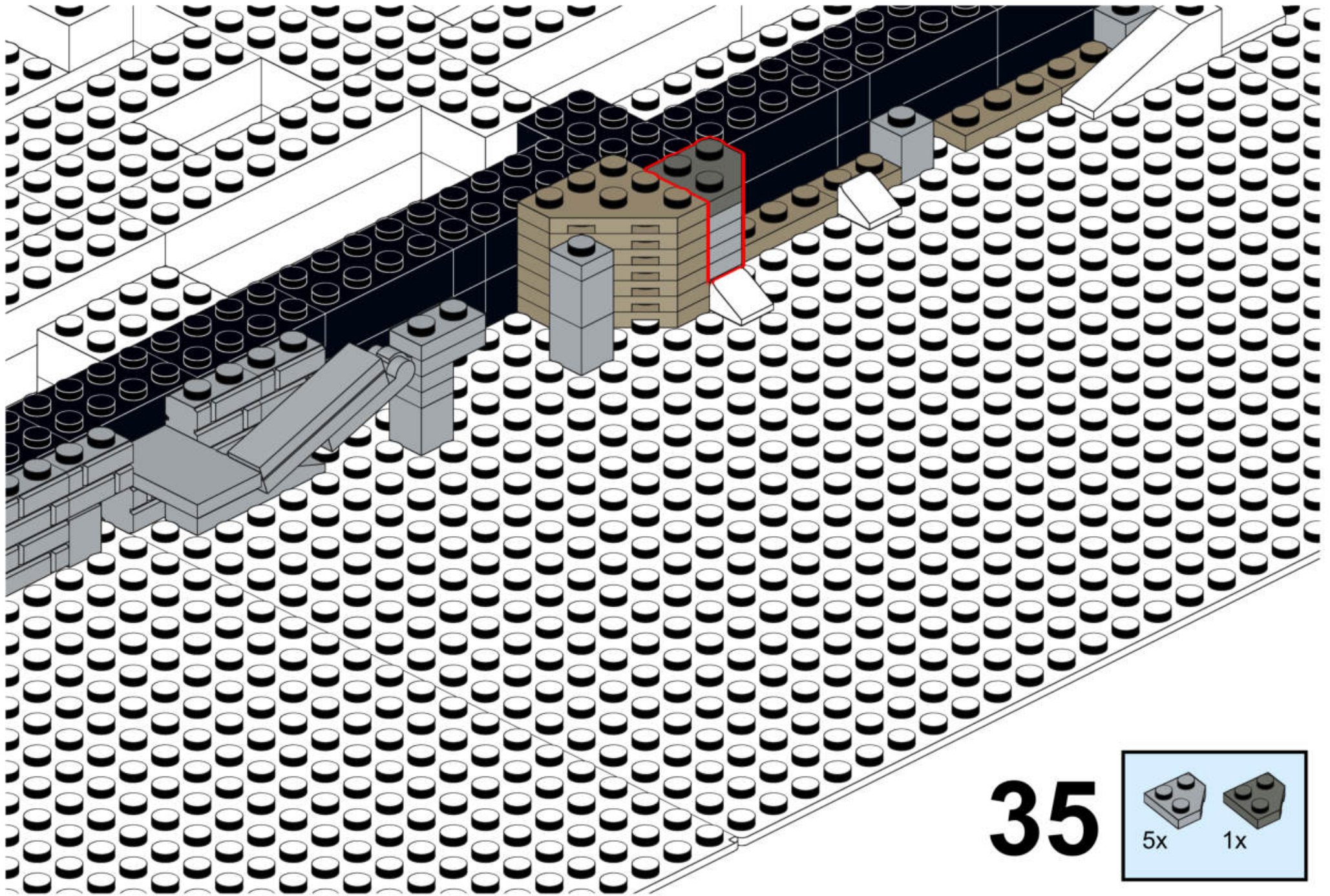

35

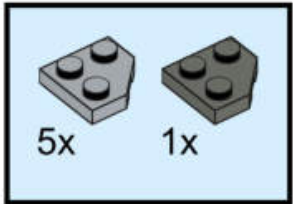



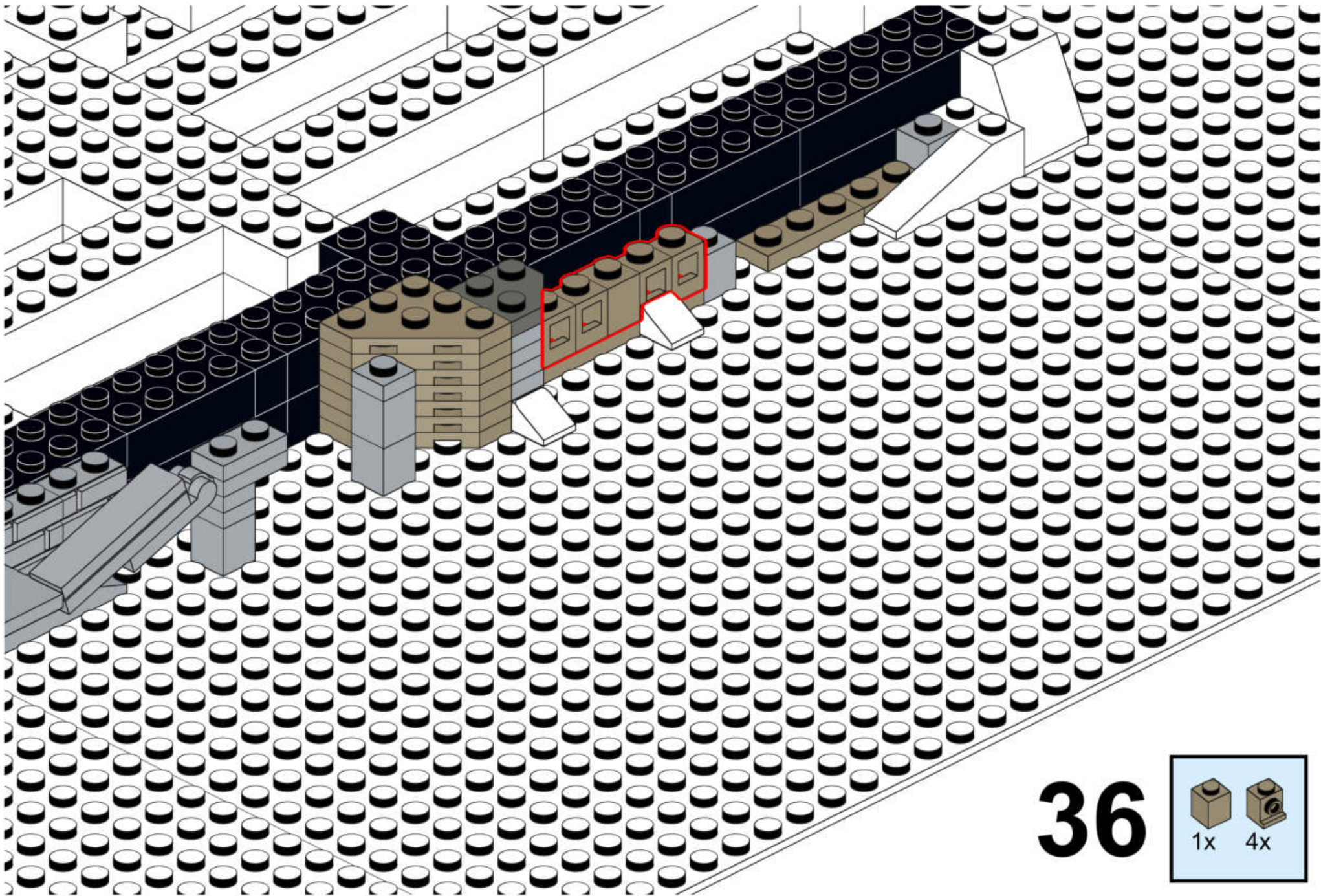

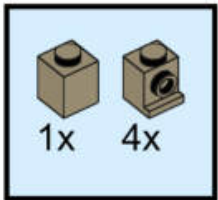

36



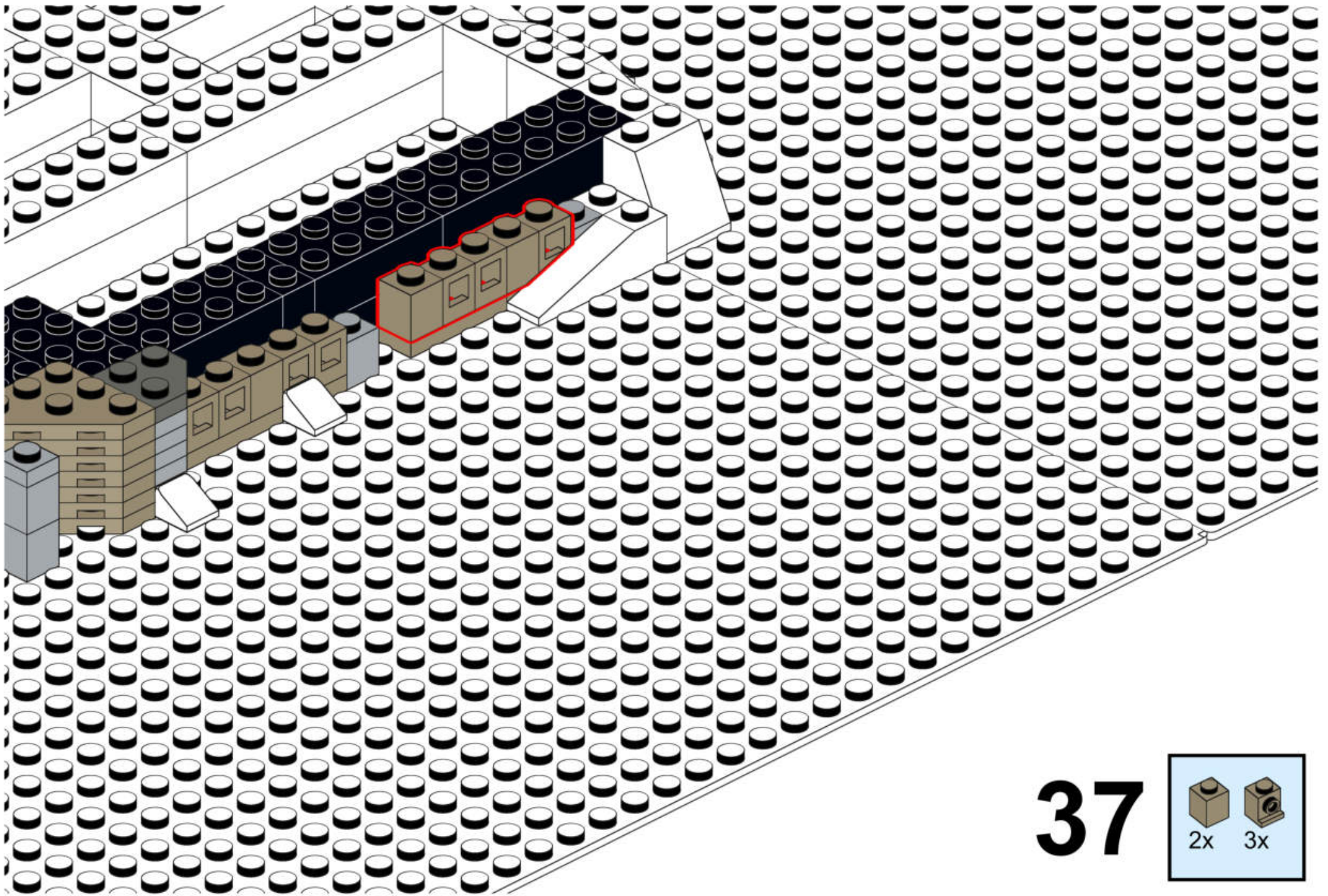



37

	
2x	3x



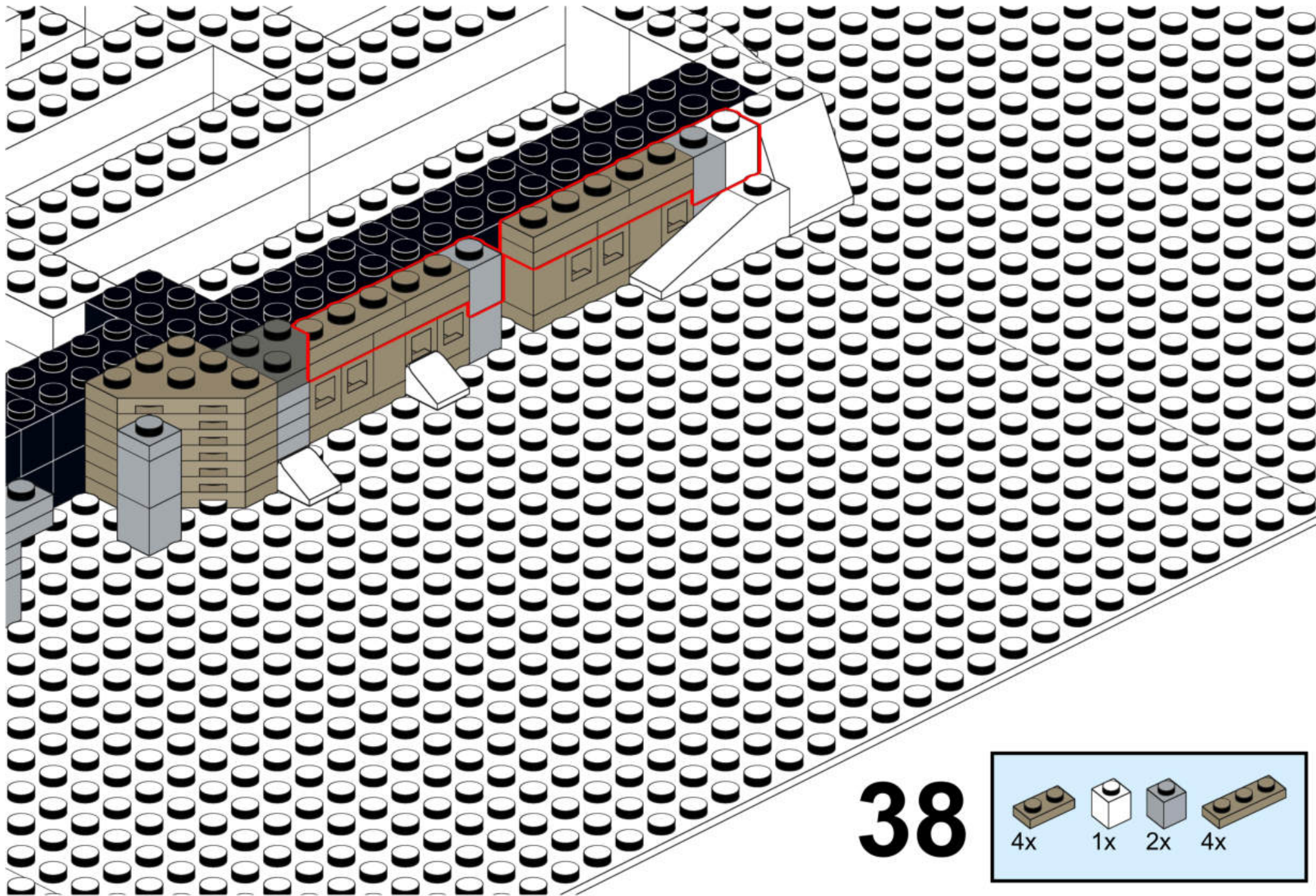



# 39

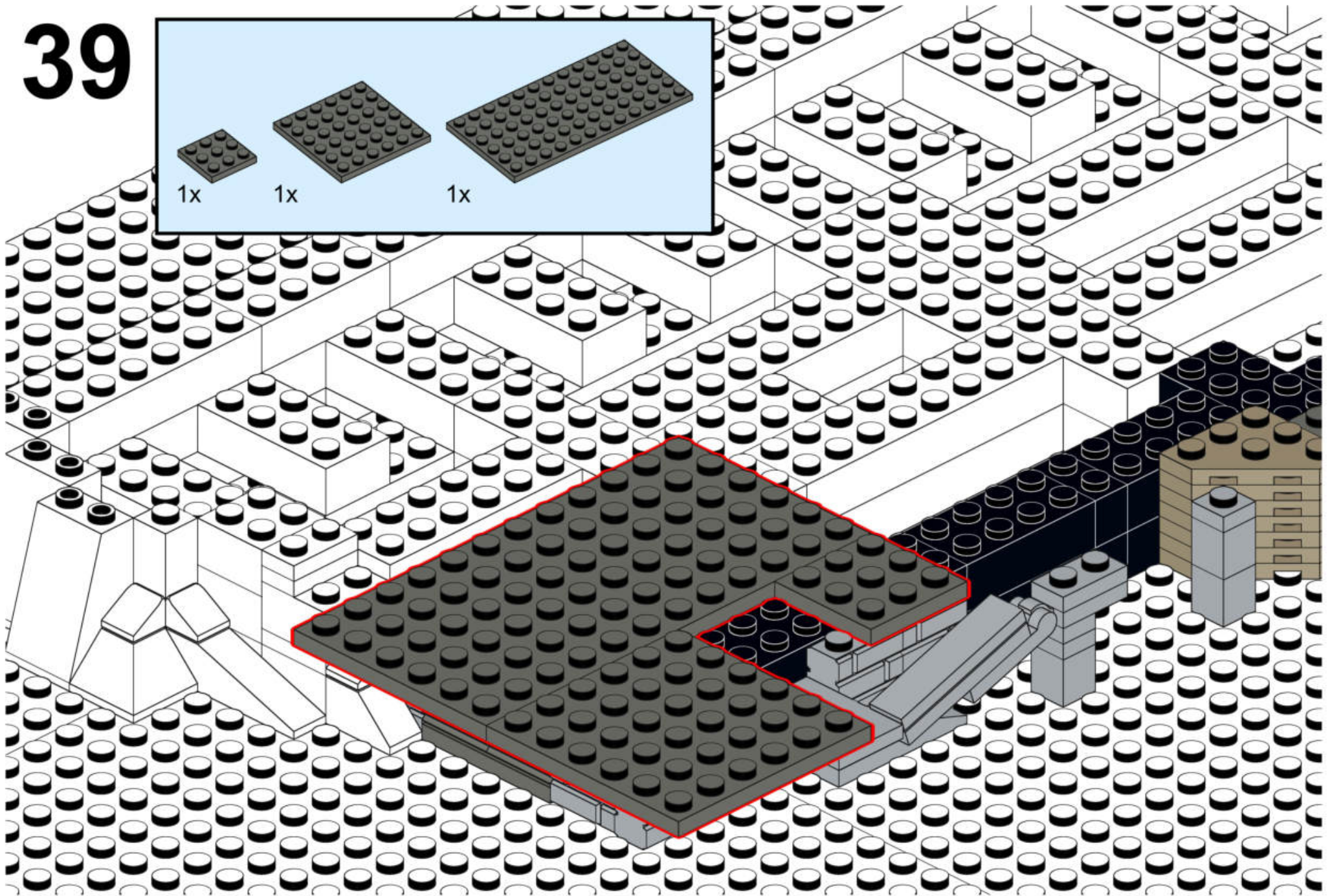
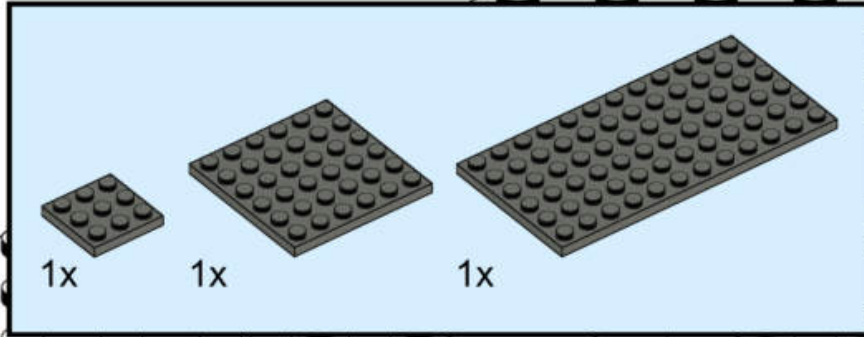



# 40

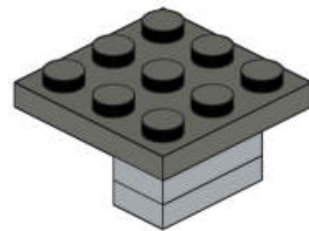
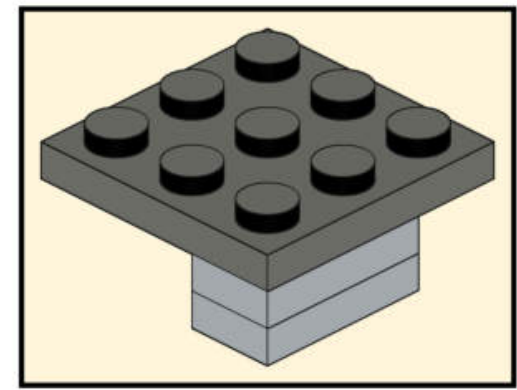
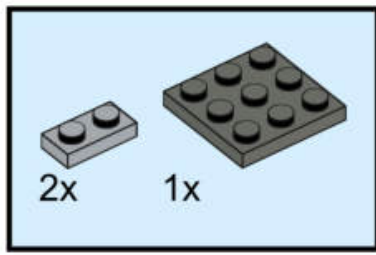



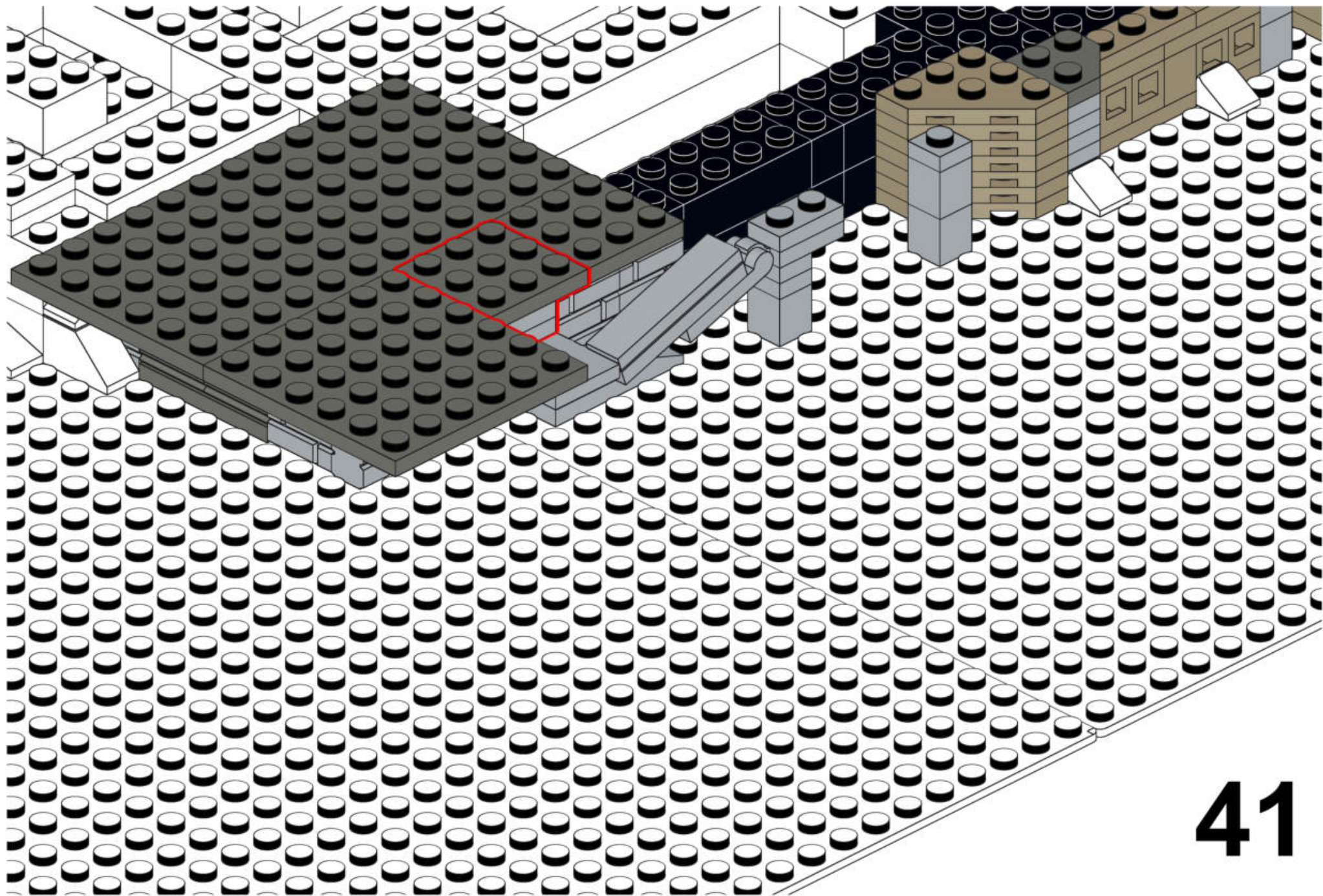

41



# 42

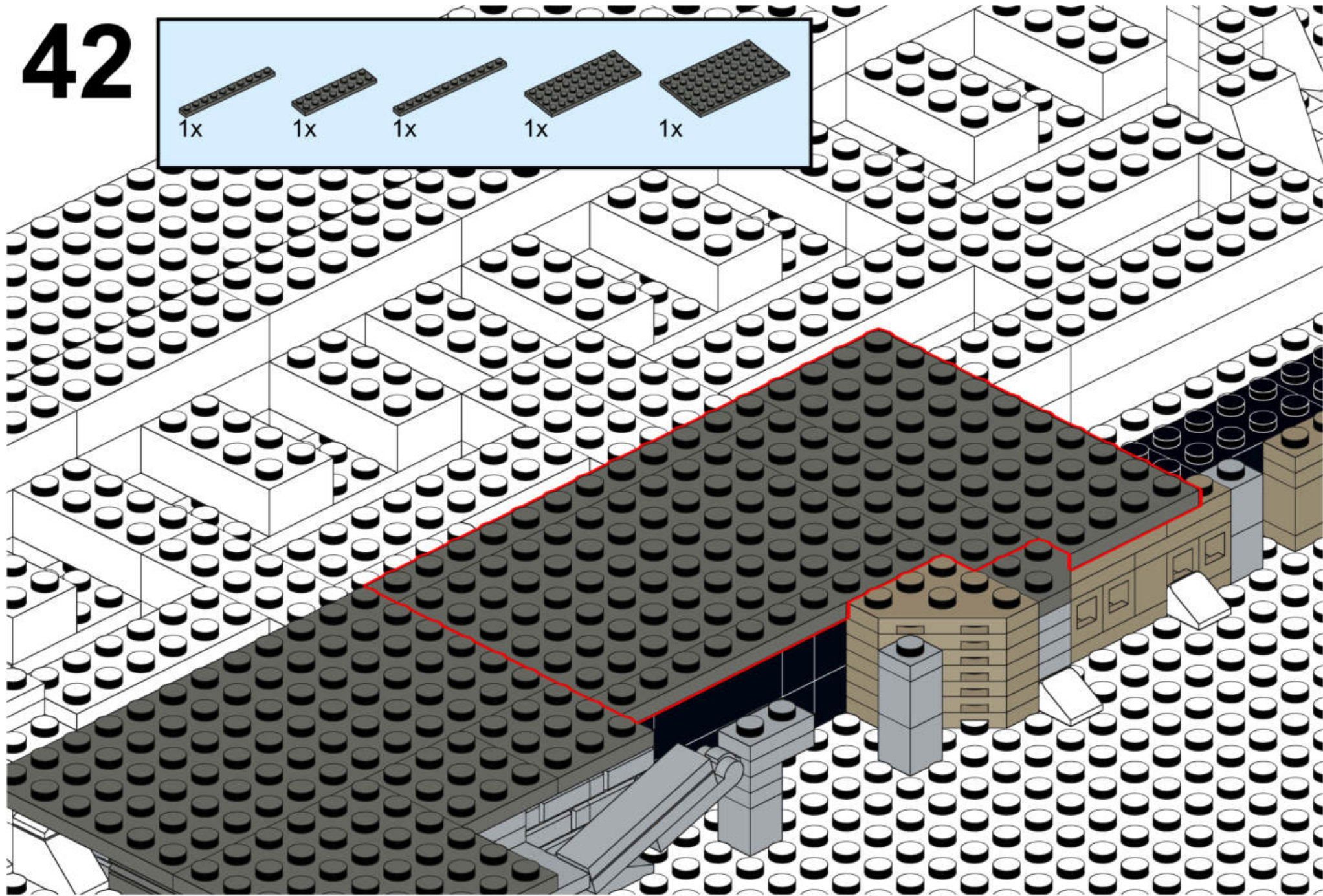
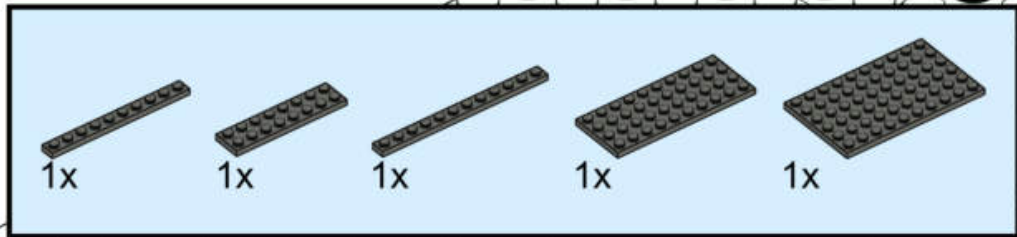



# 43

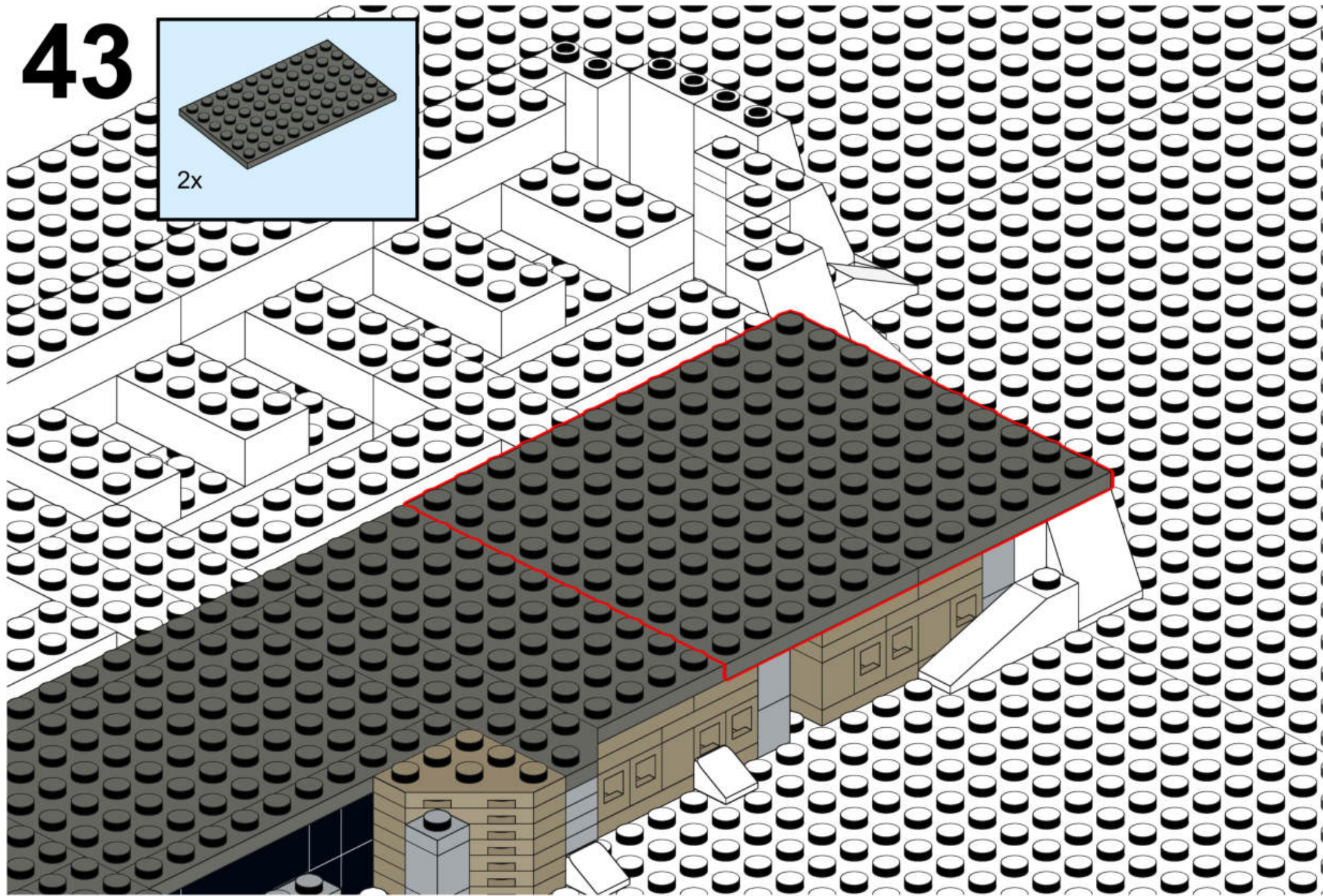
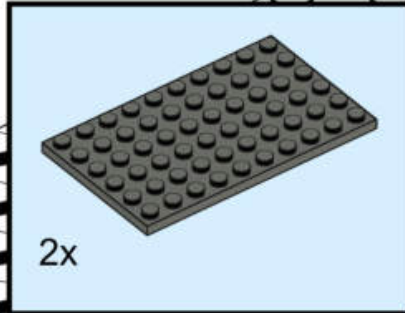



# 44

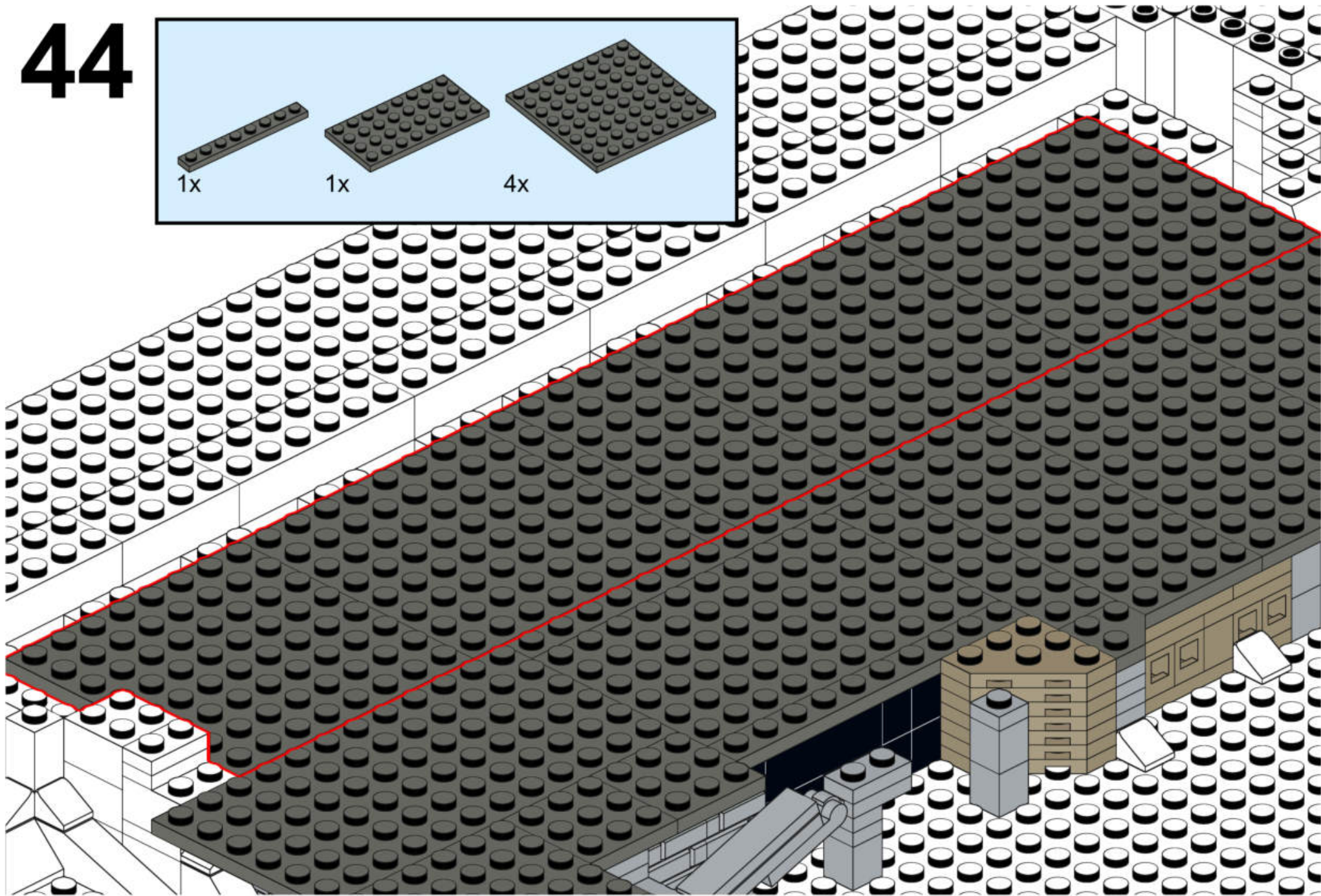
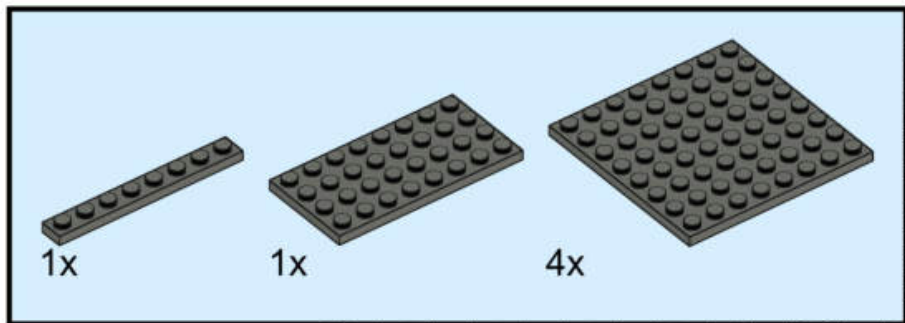



# 45

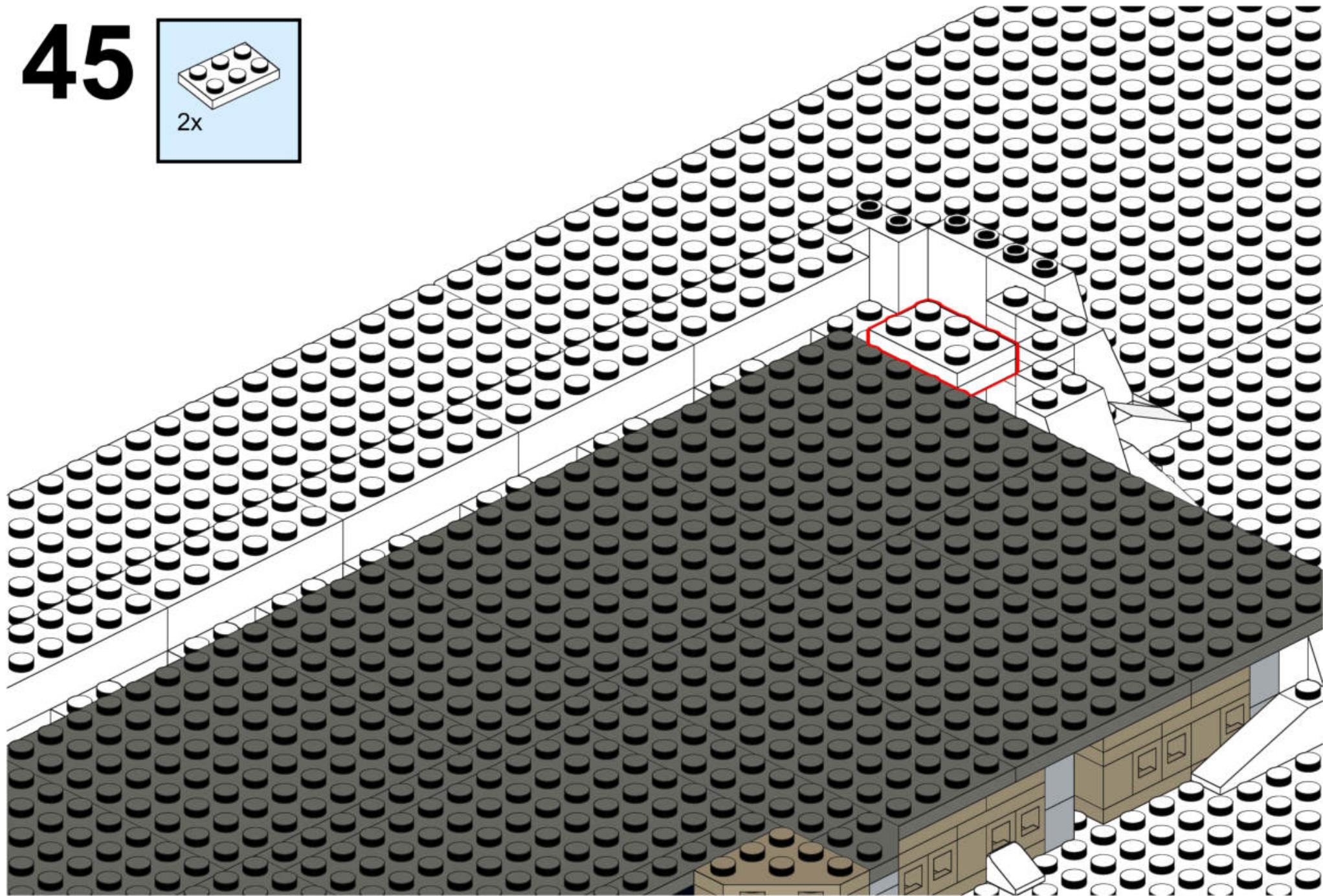
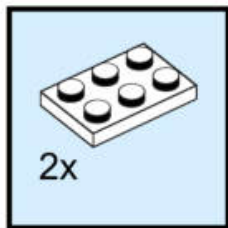



# 46

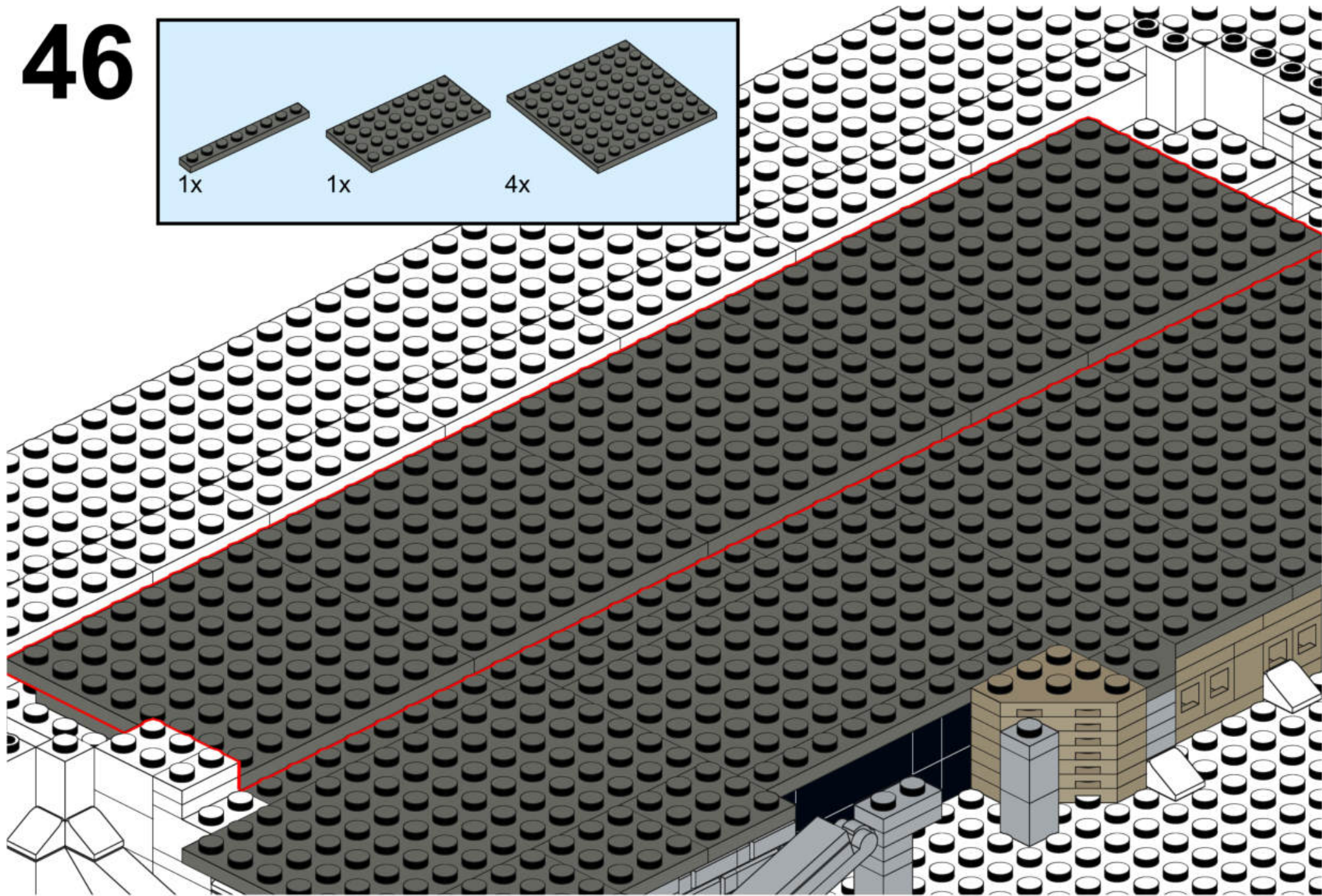
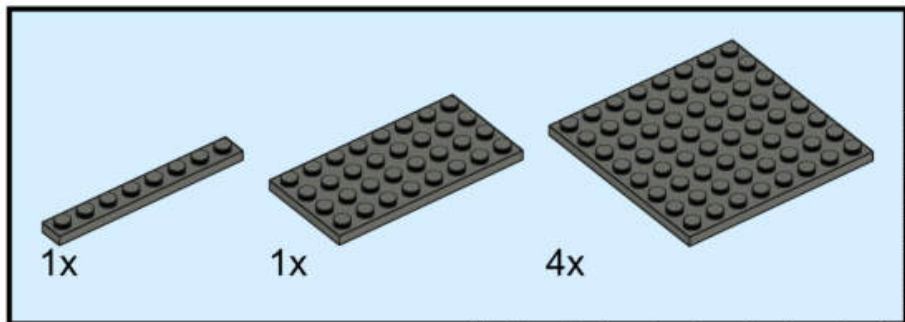



# 47

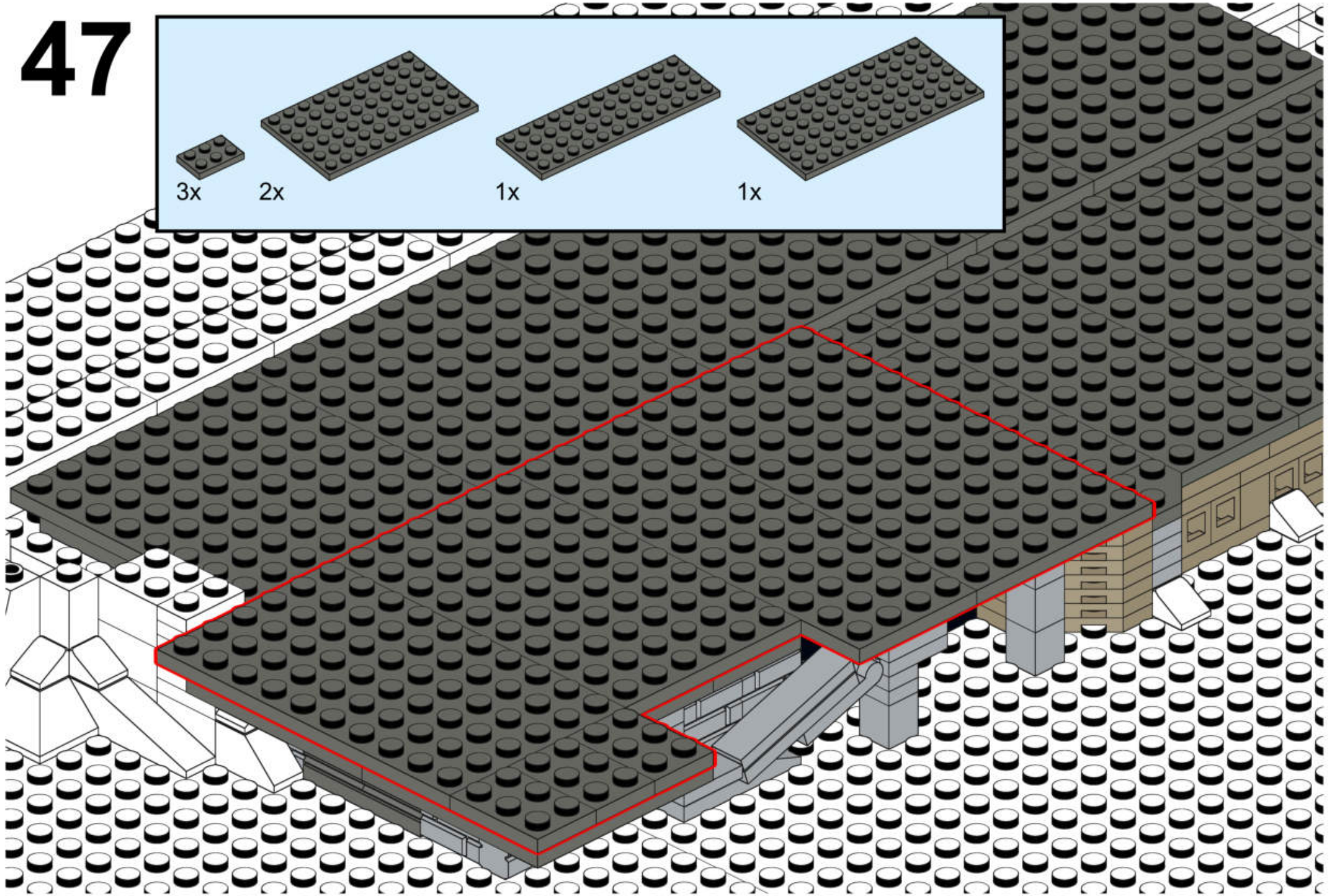
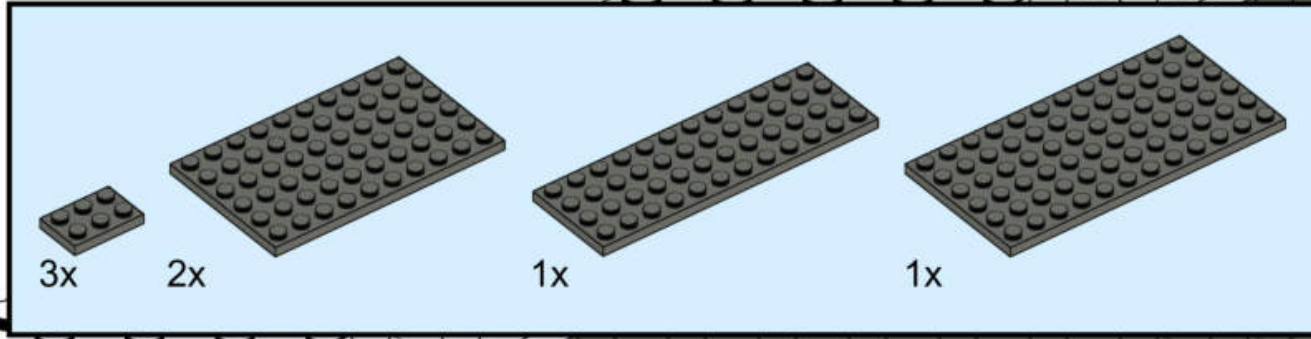



# 48

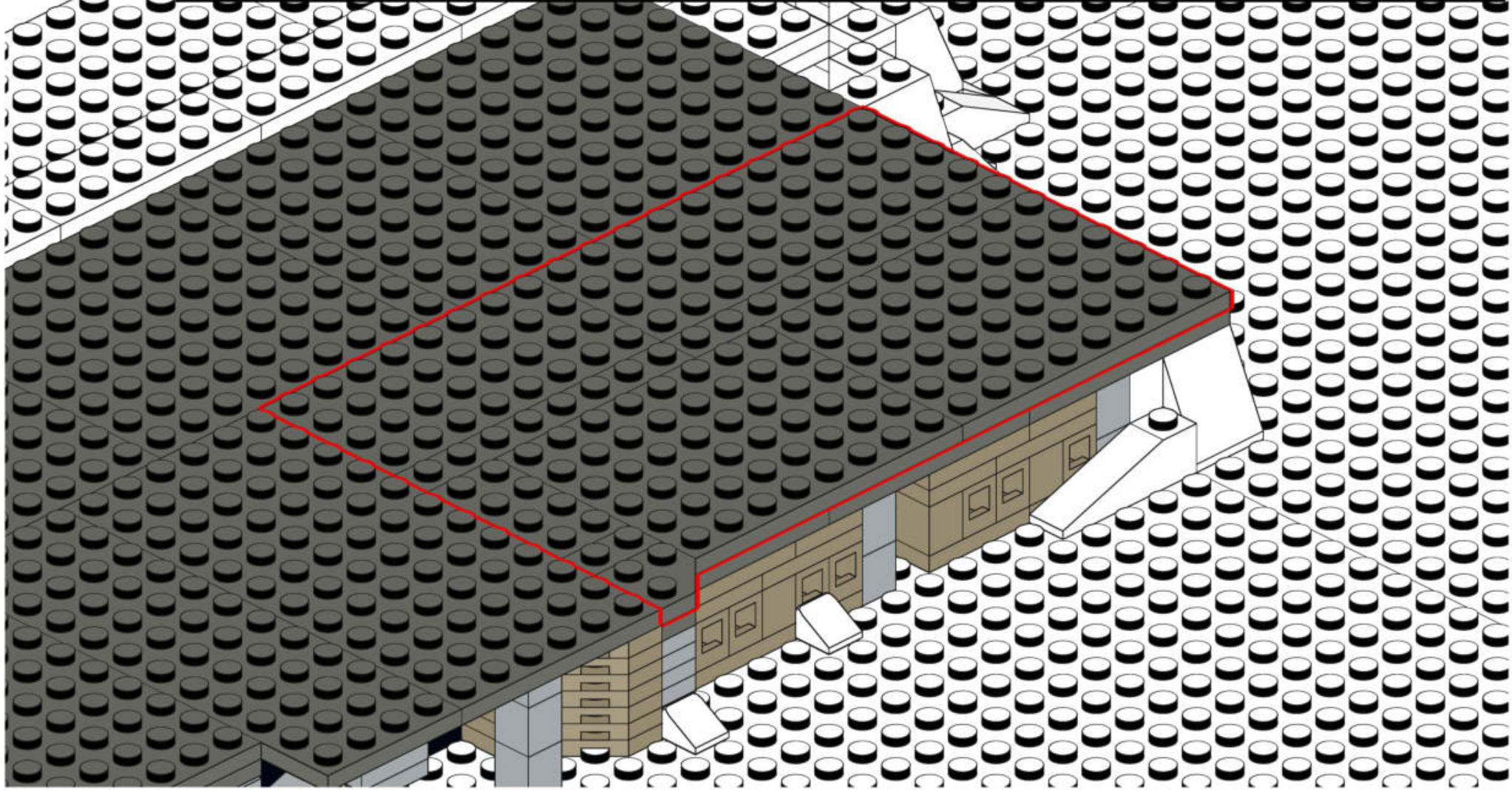
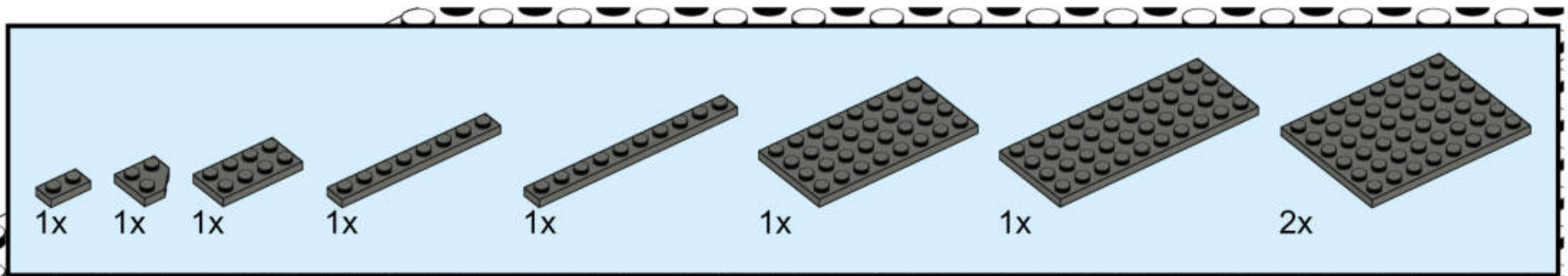



# 49

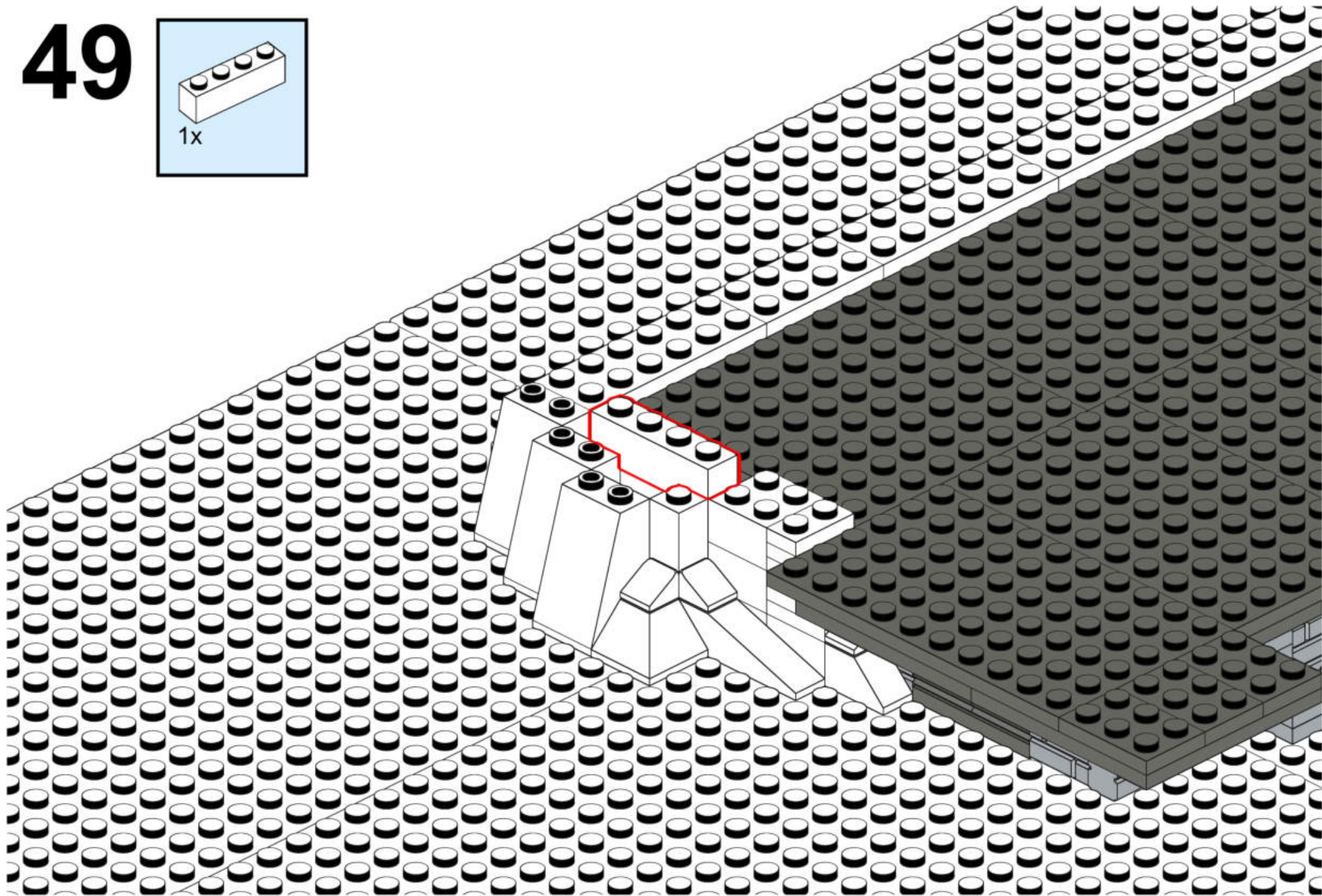
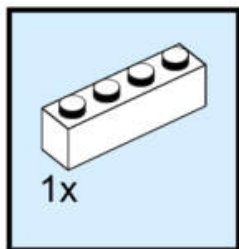



# 50

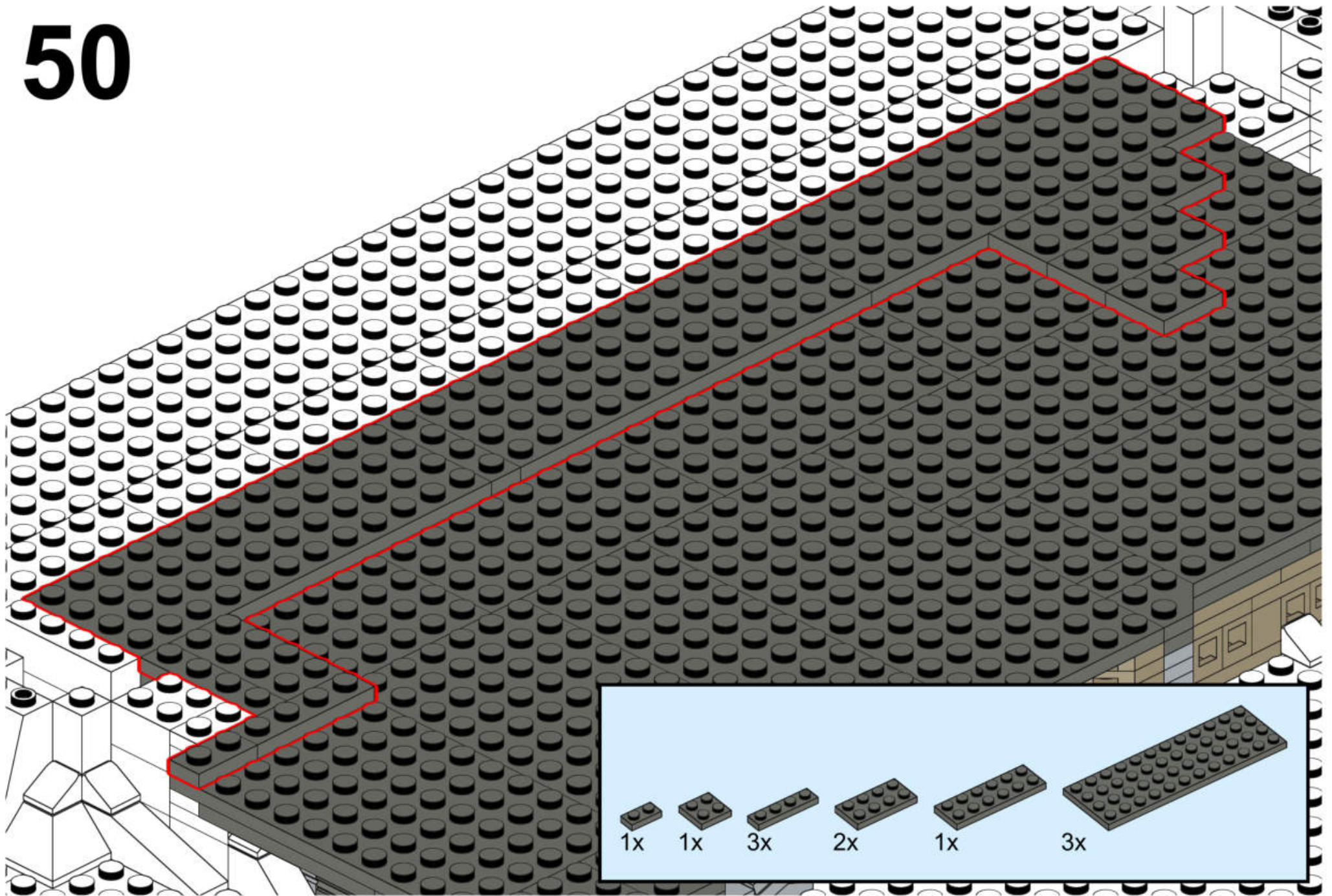



51

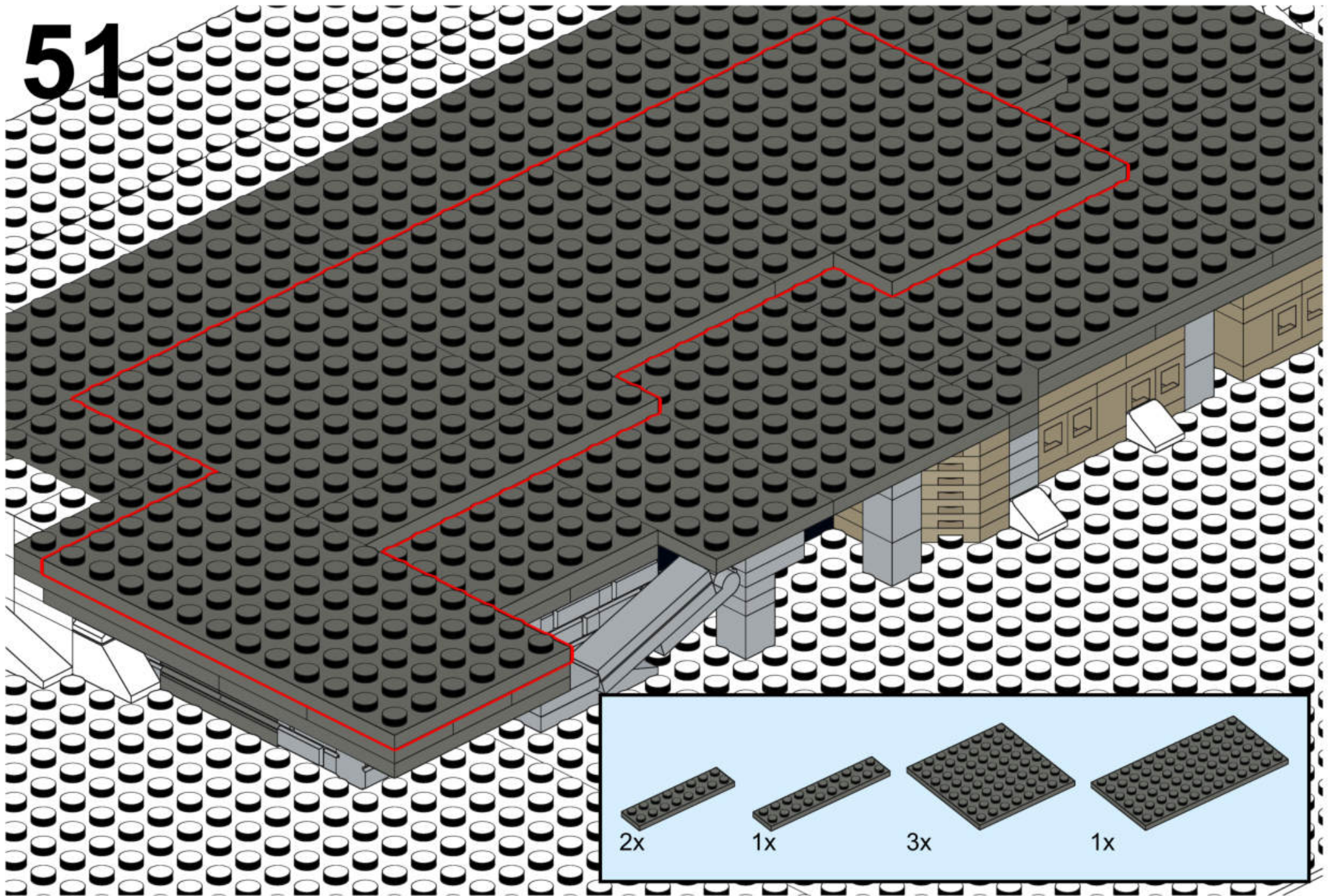



# 52

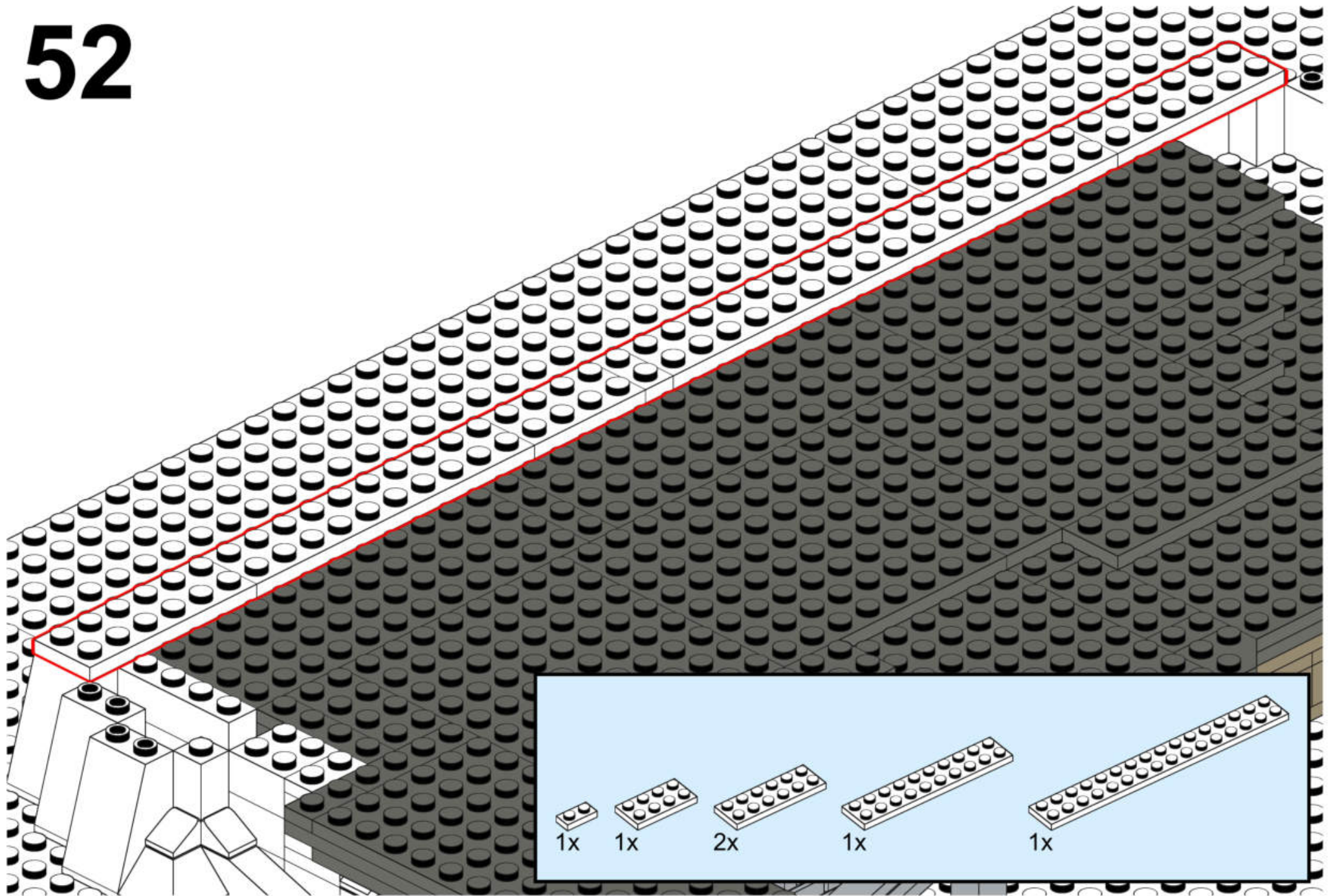



# 53

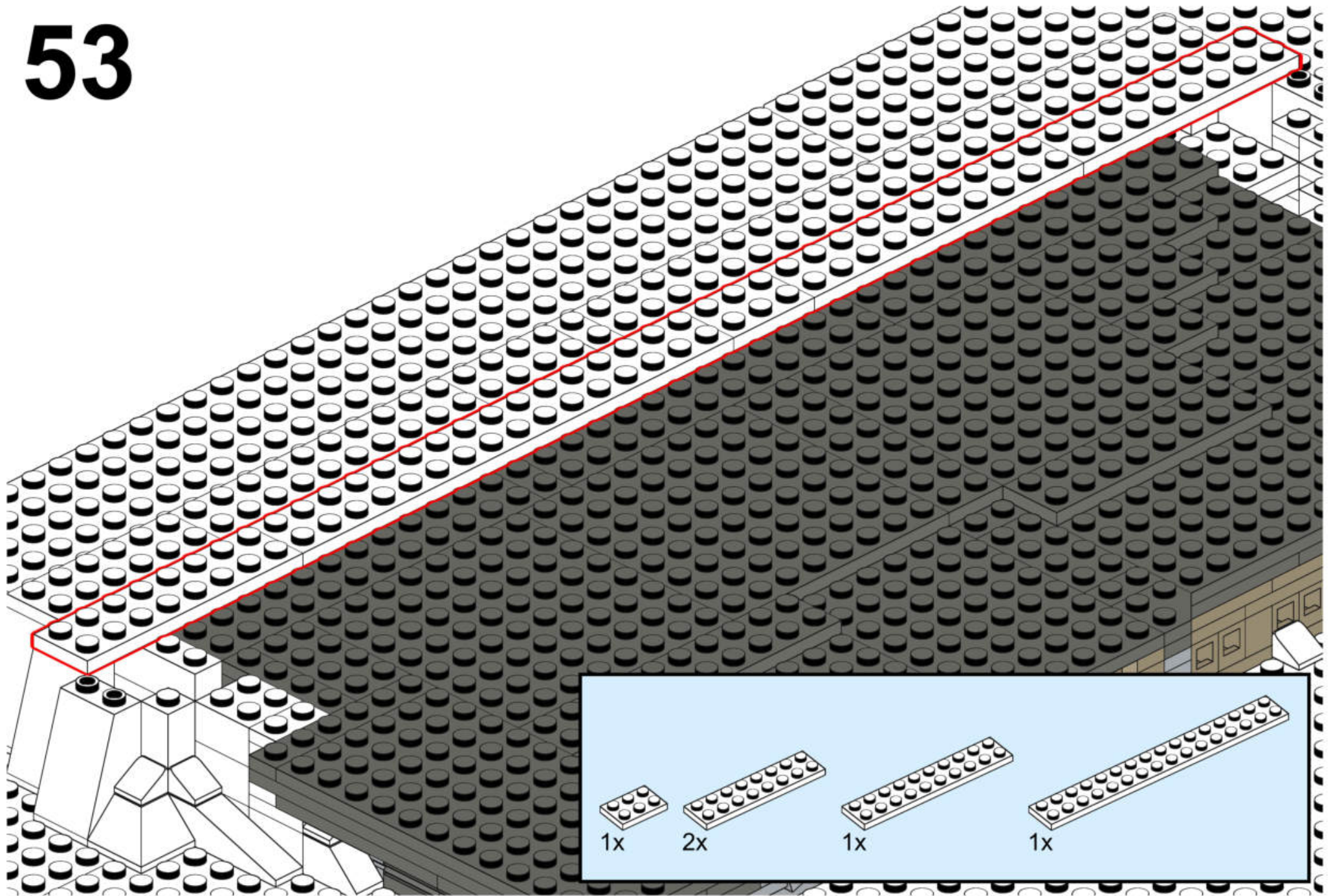



# 54

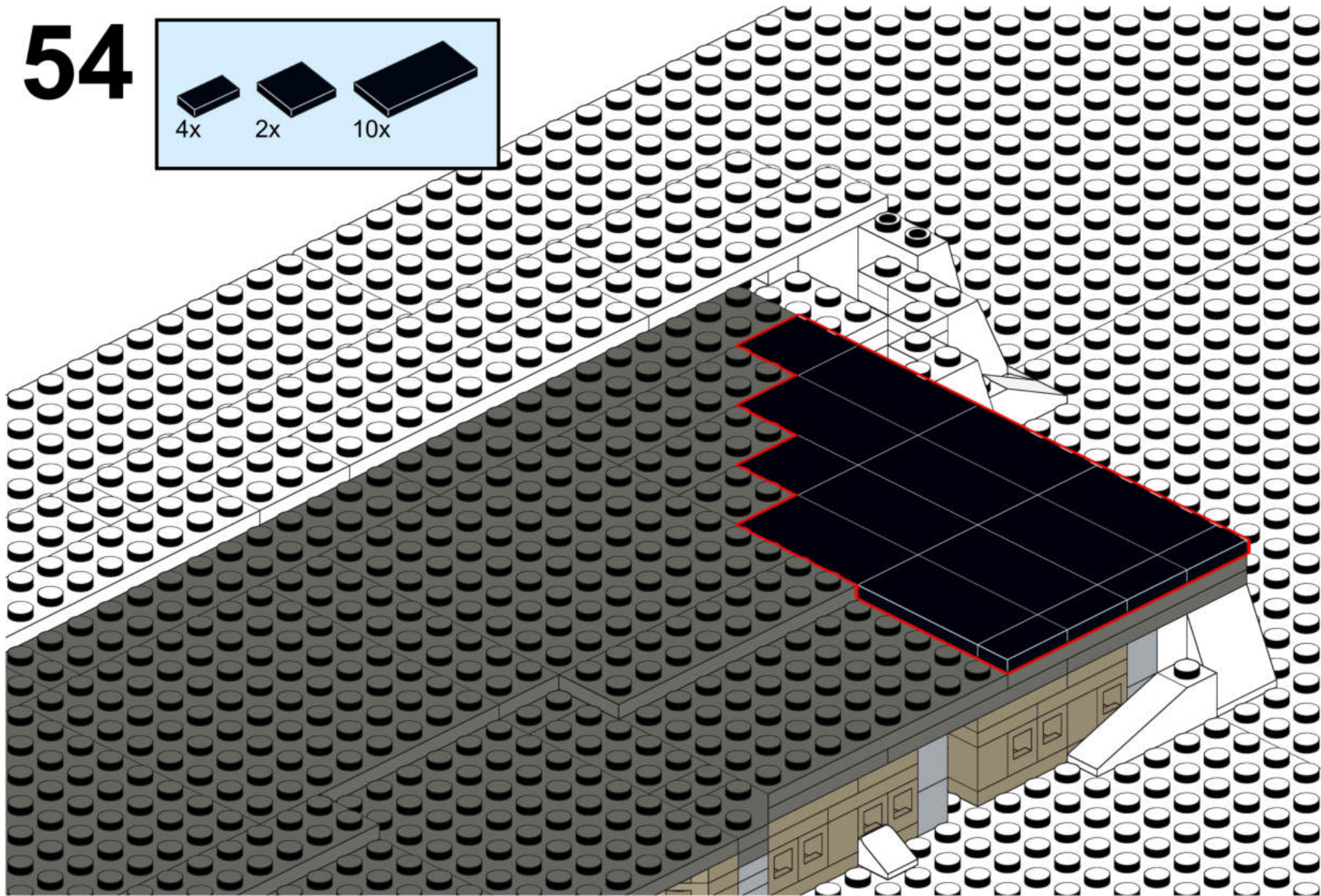
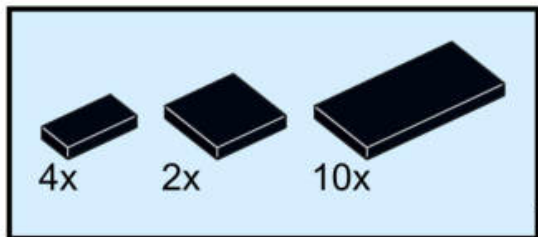



# 55

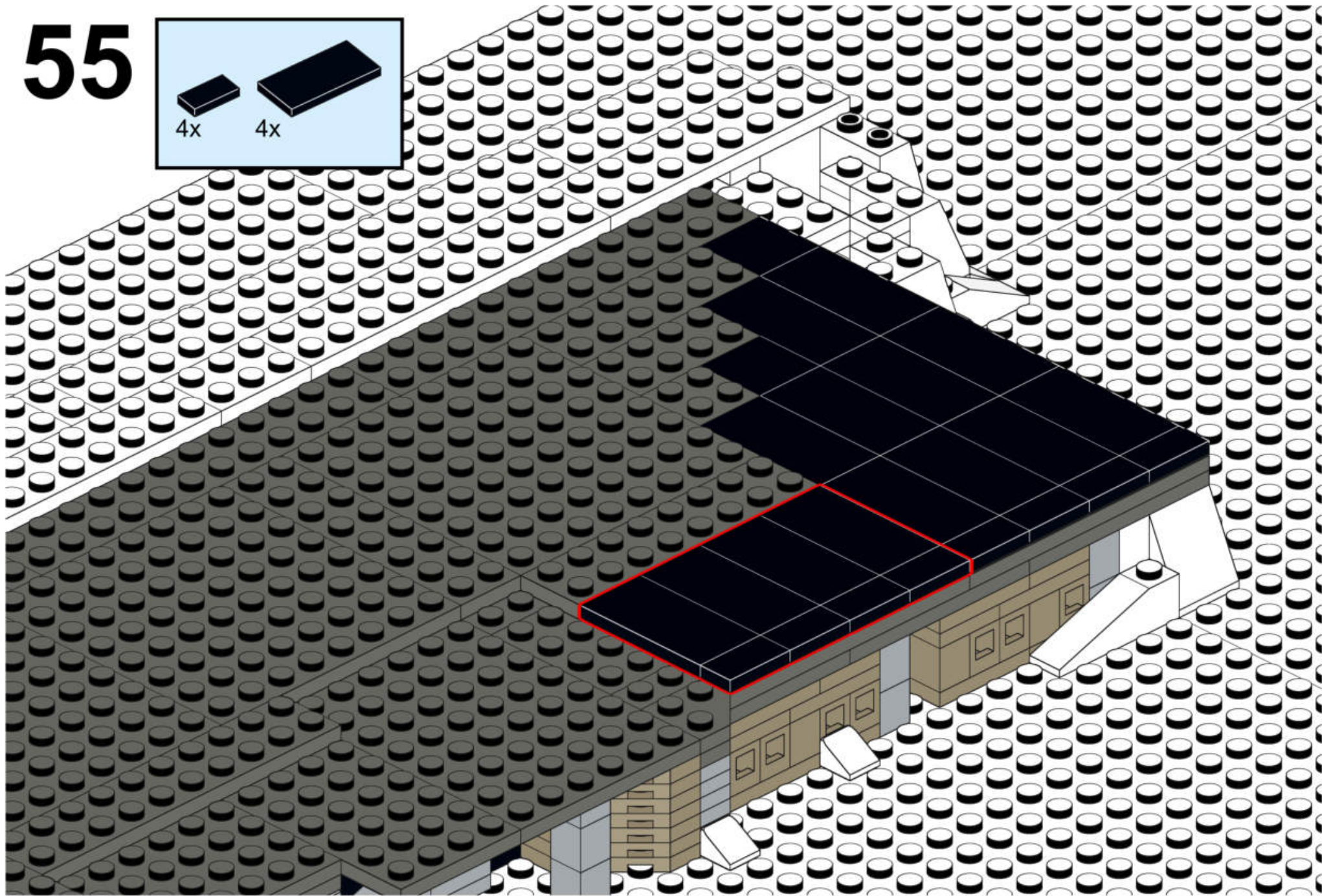
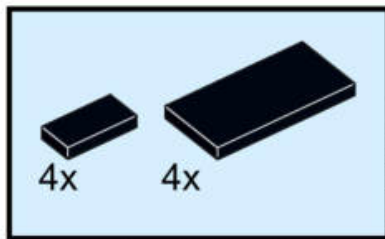



# 56

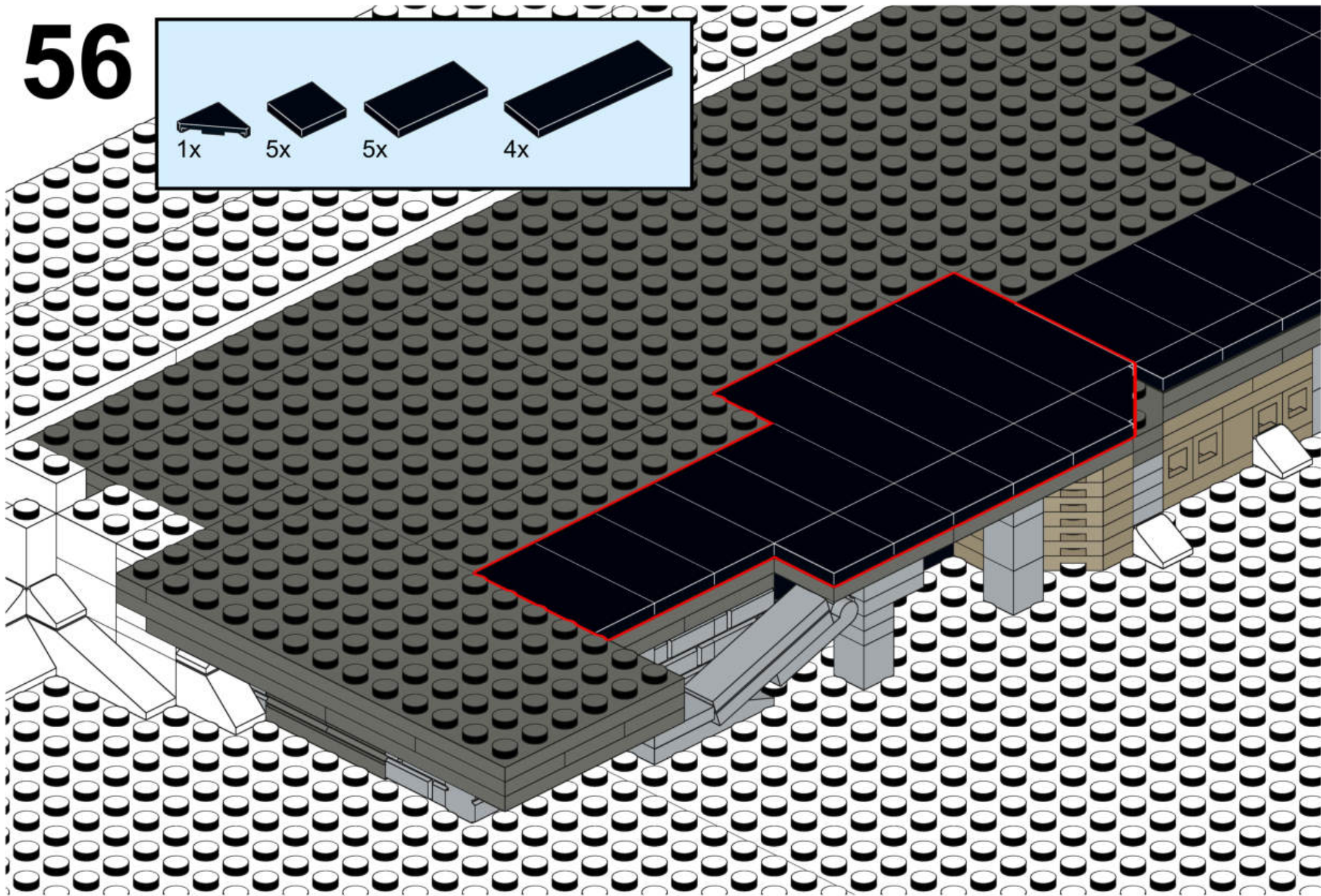
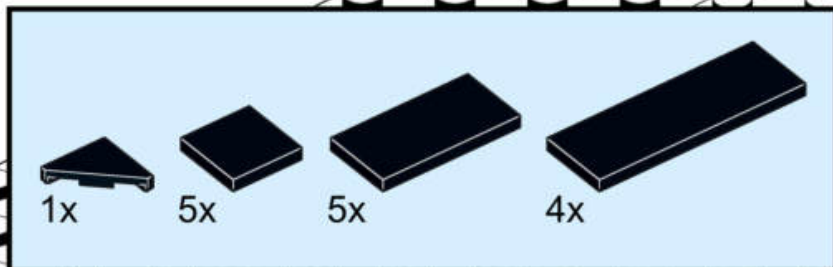



# 57

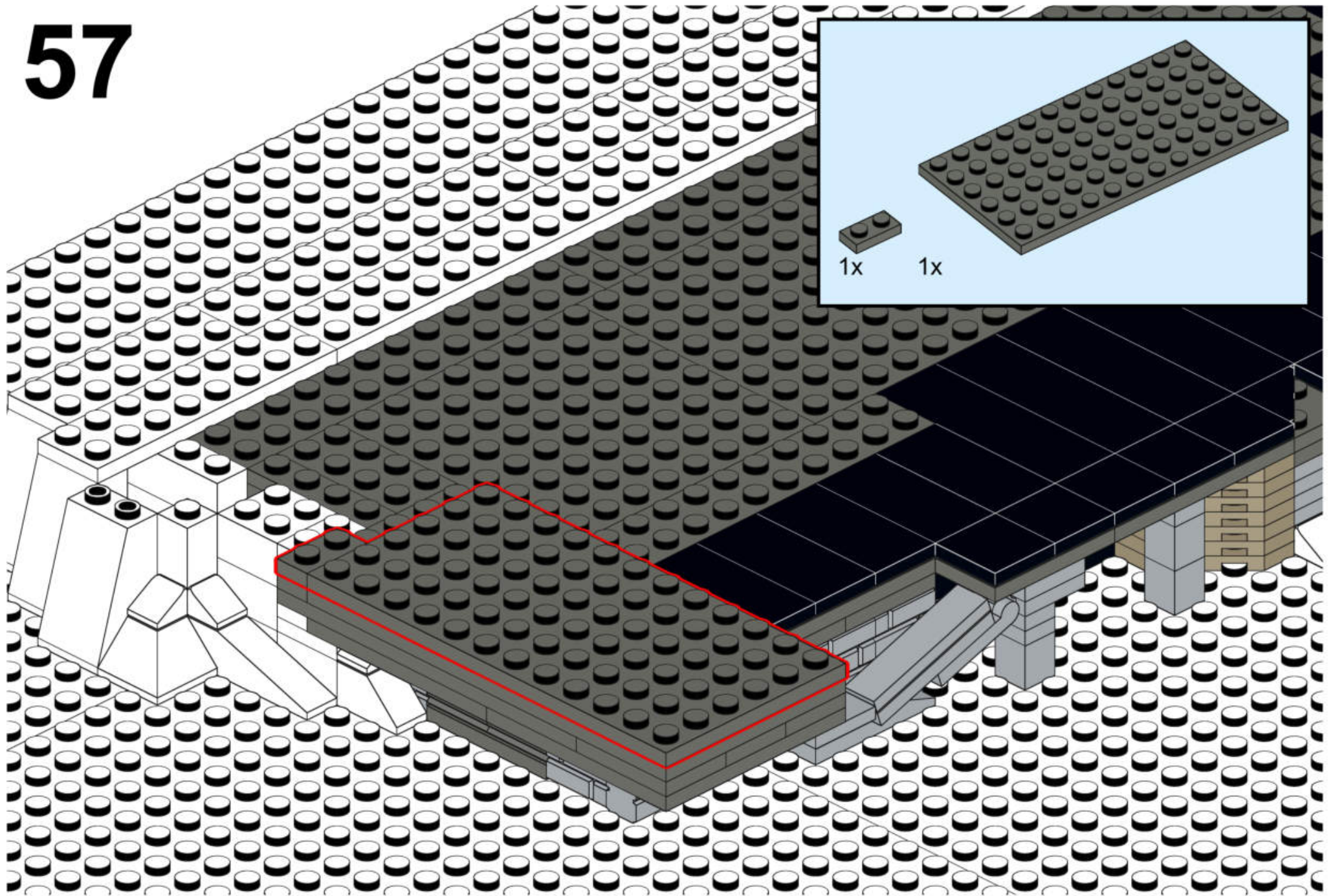



# 58

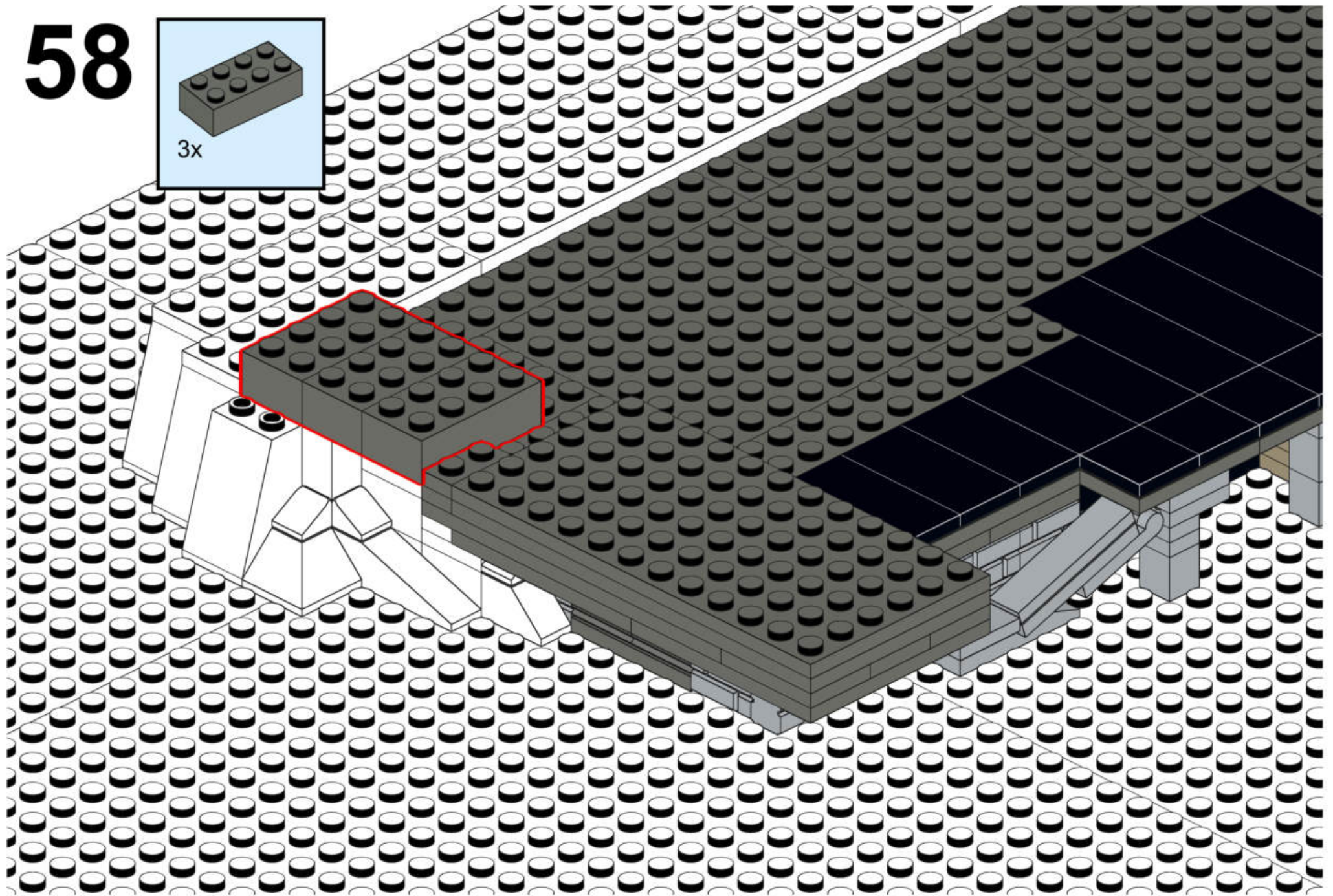
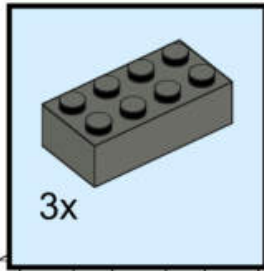



# 59

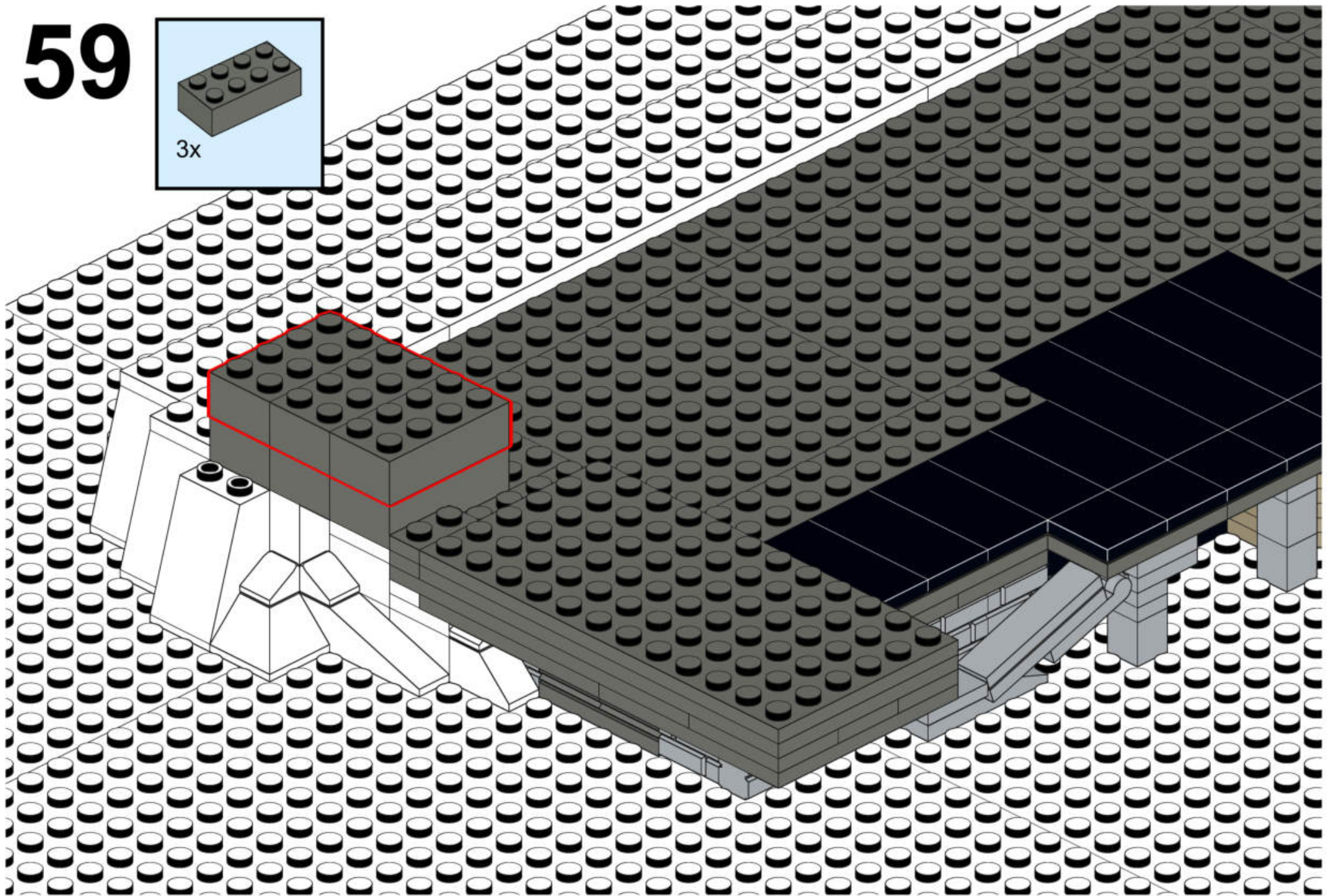
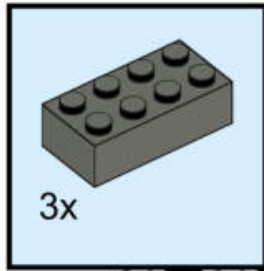



# 60

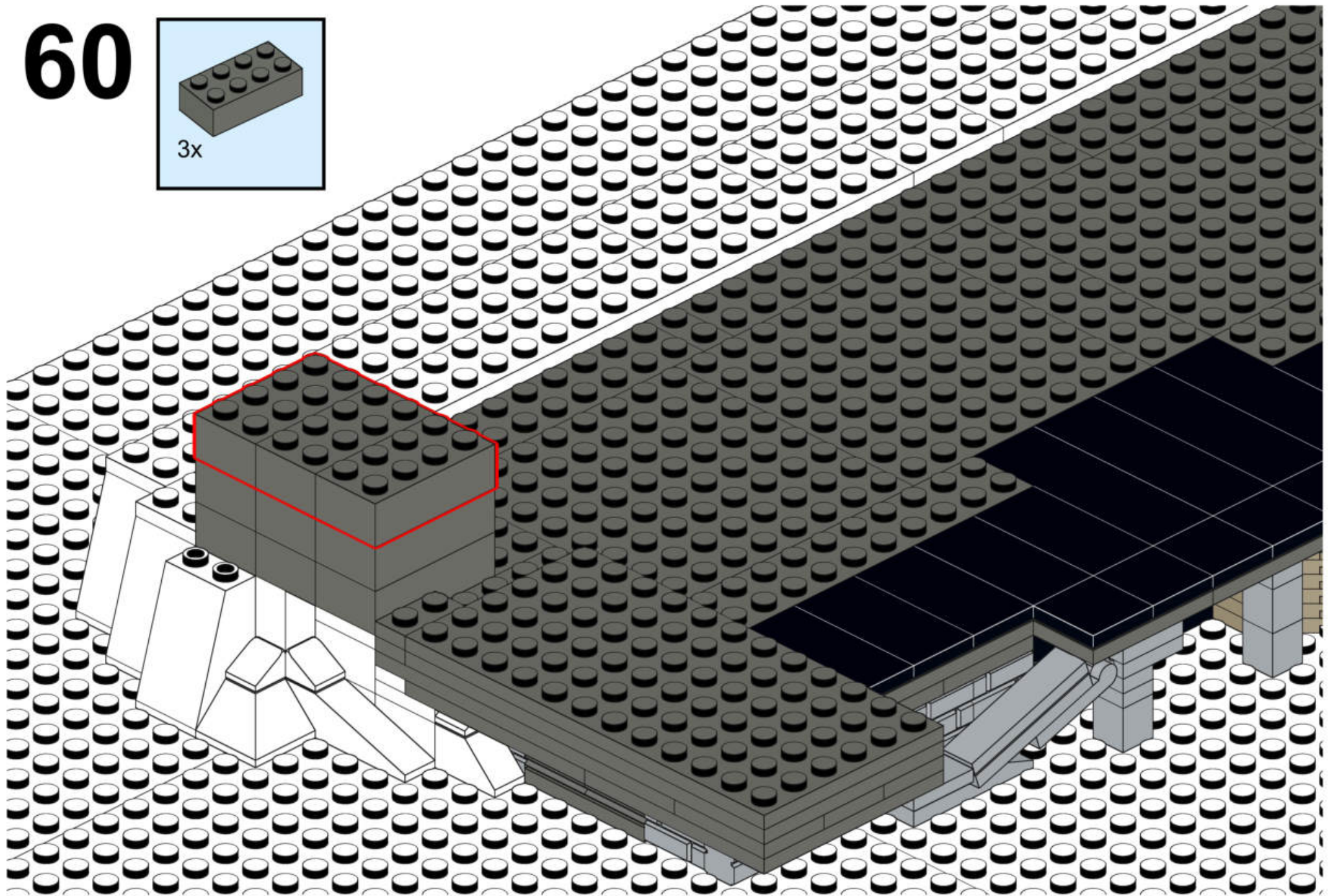
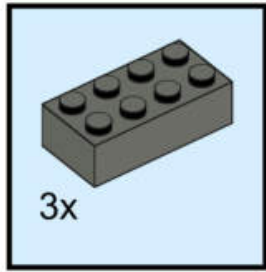



# 61

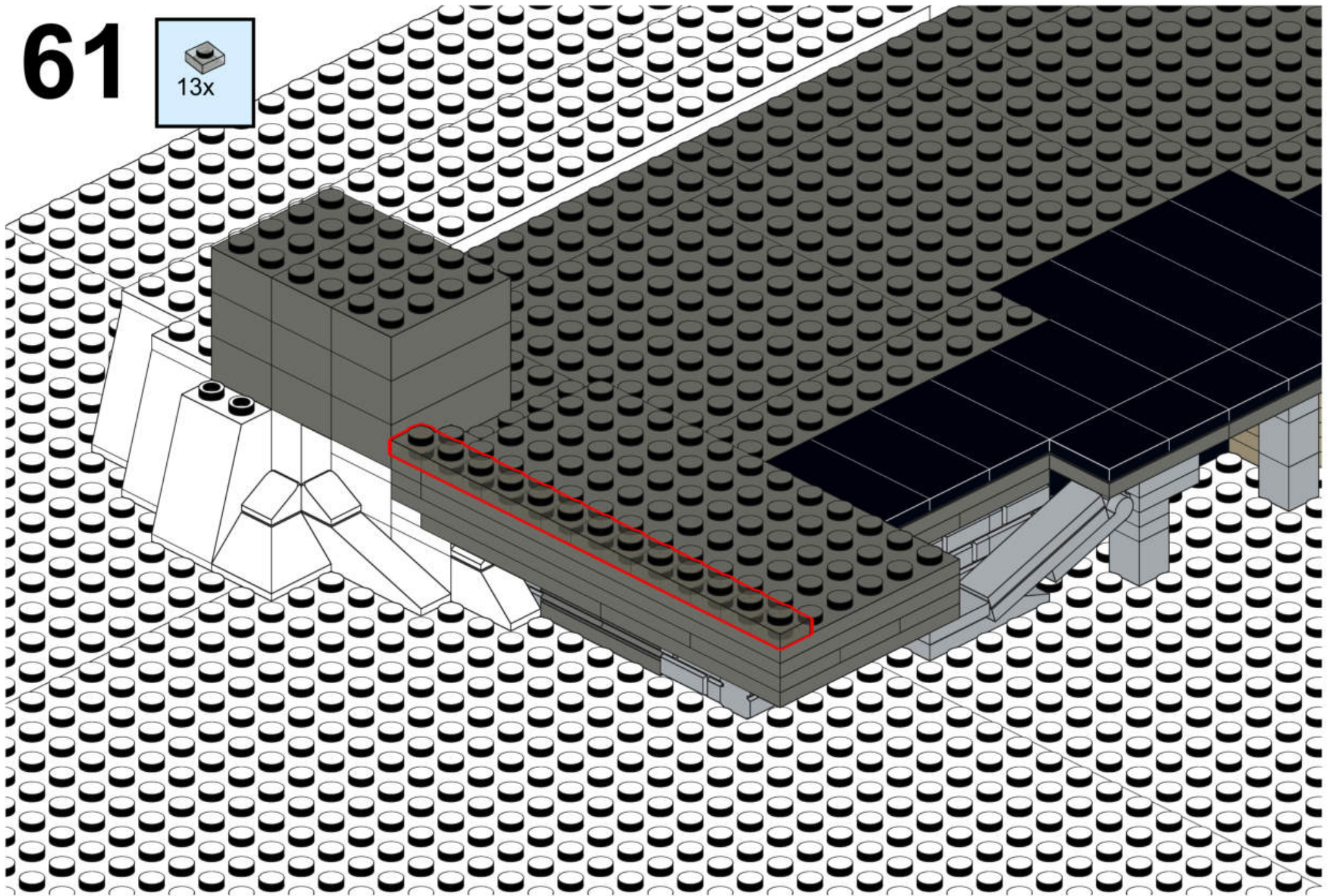



62

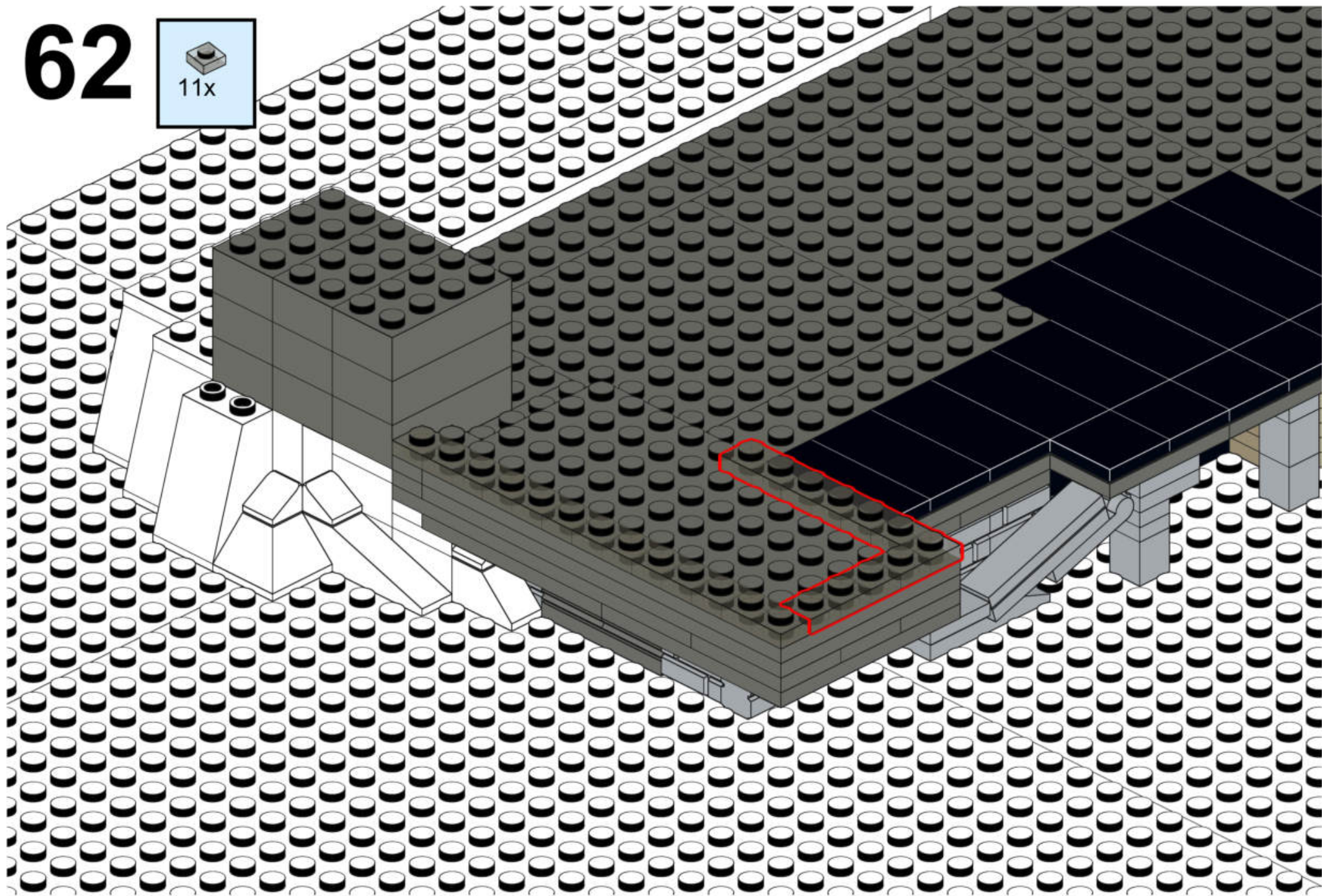
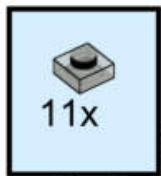



# 63

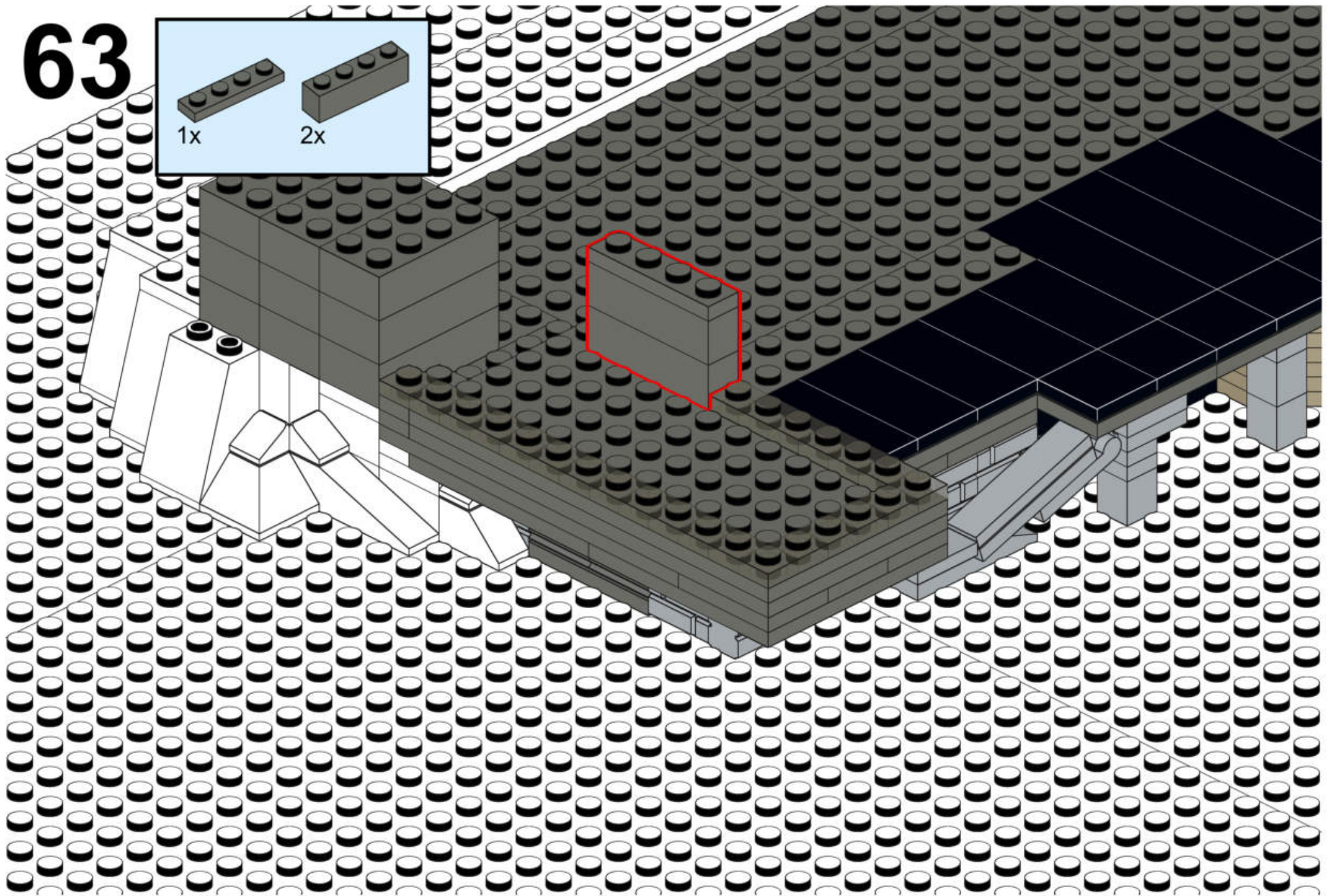
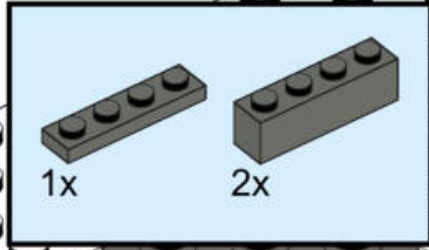



64

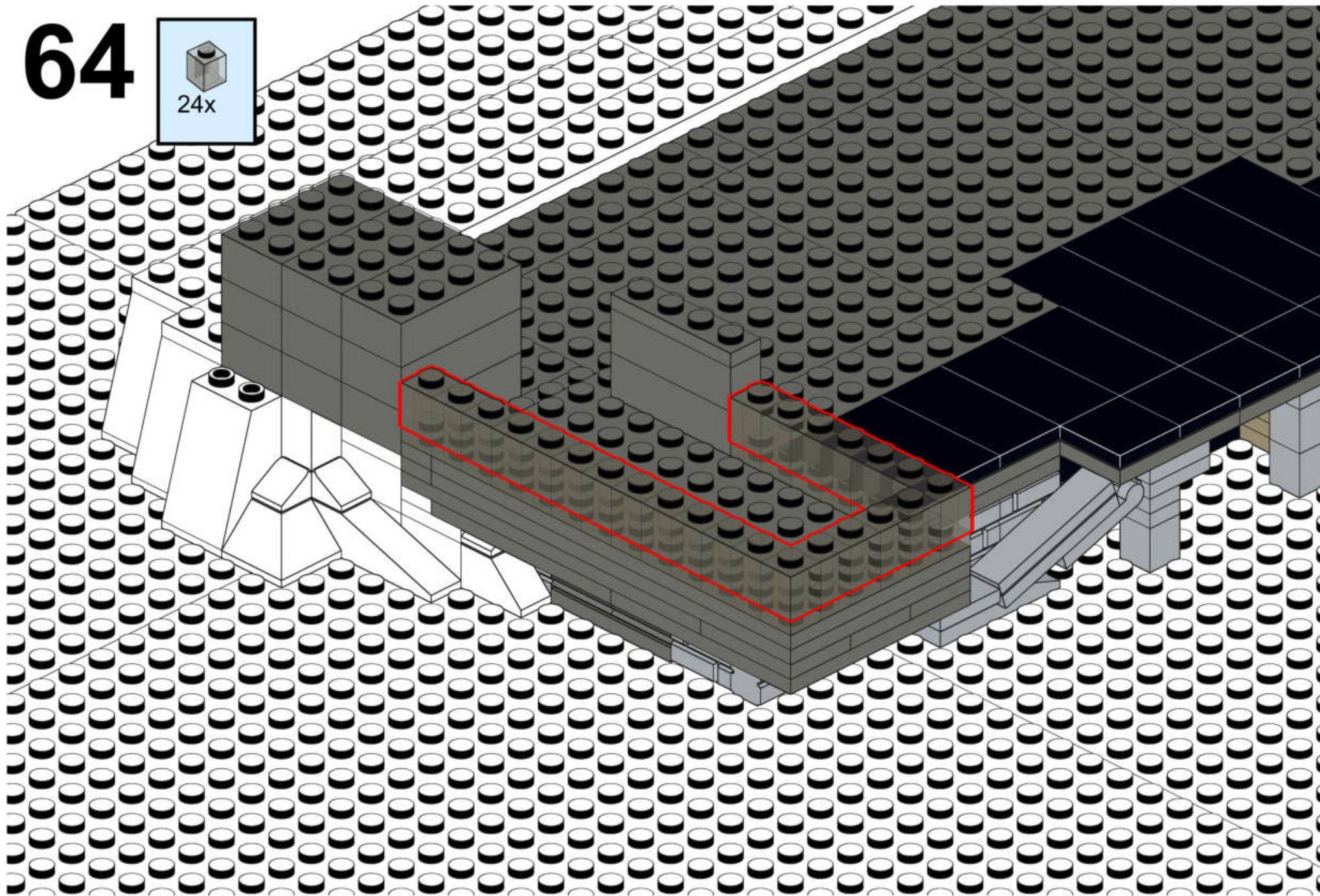
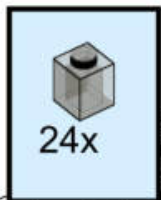



# 65

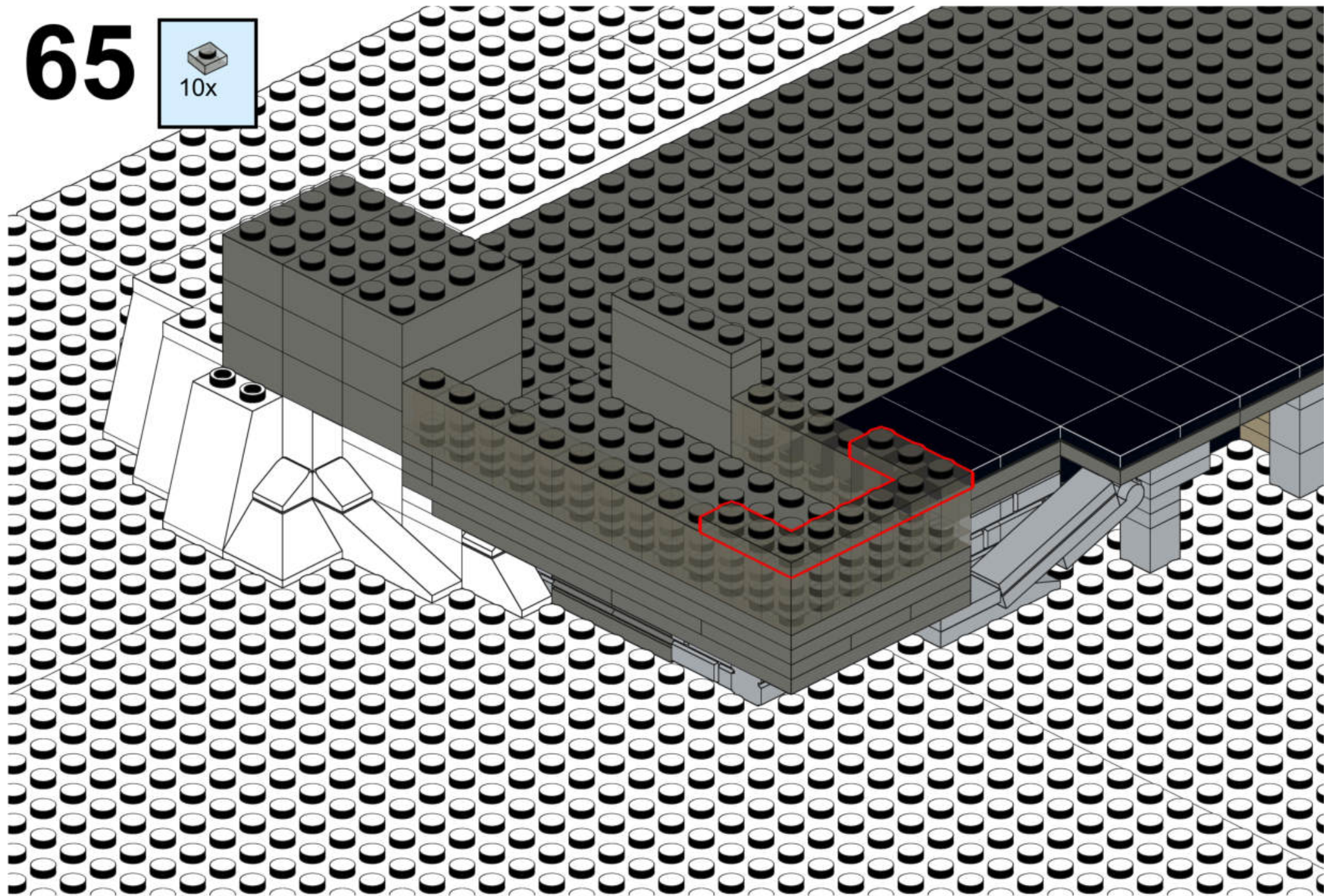
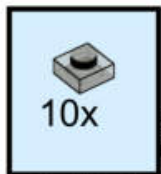



# 66

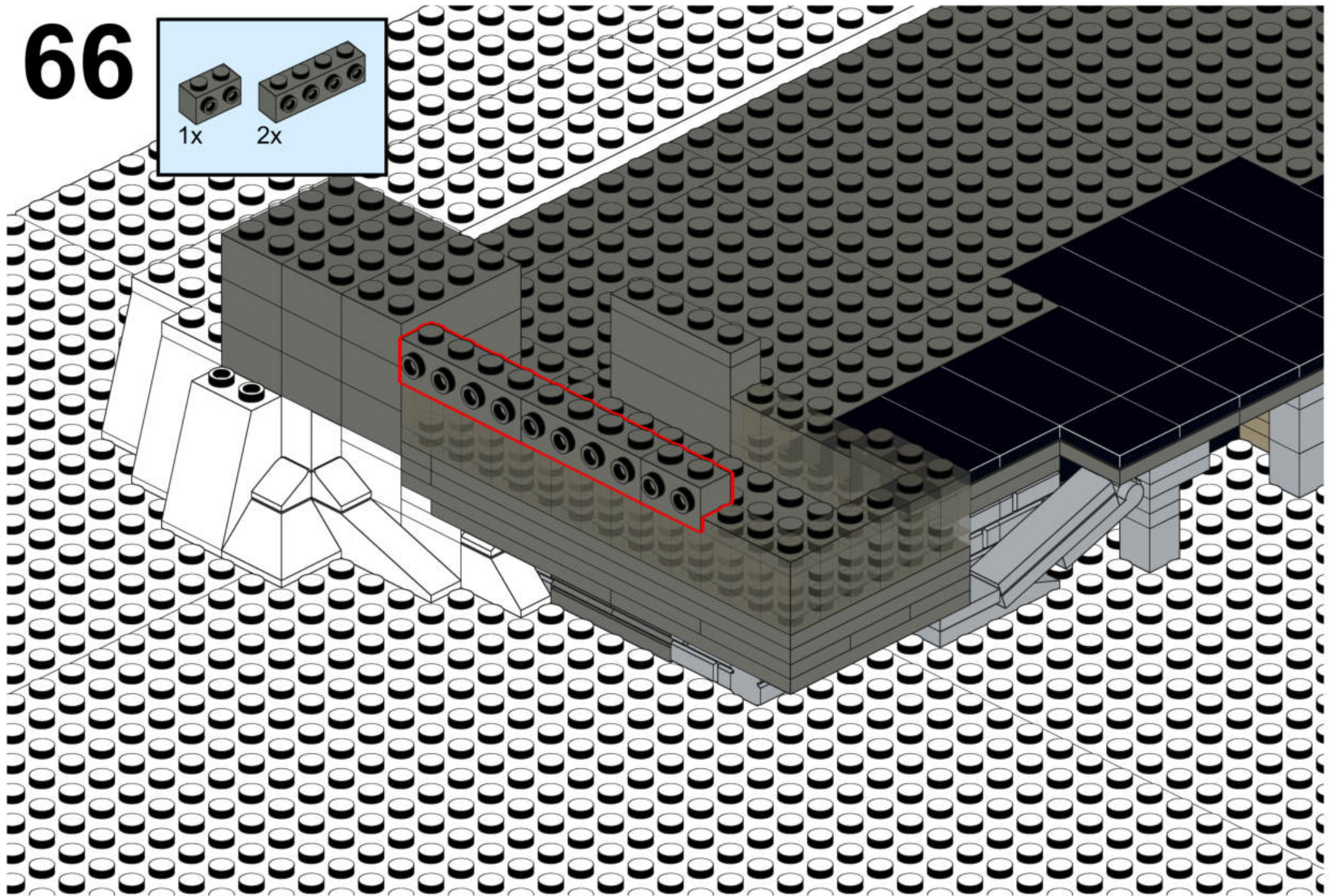
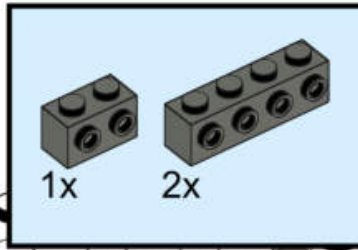



67

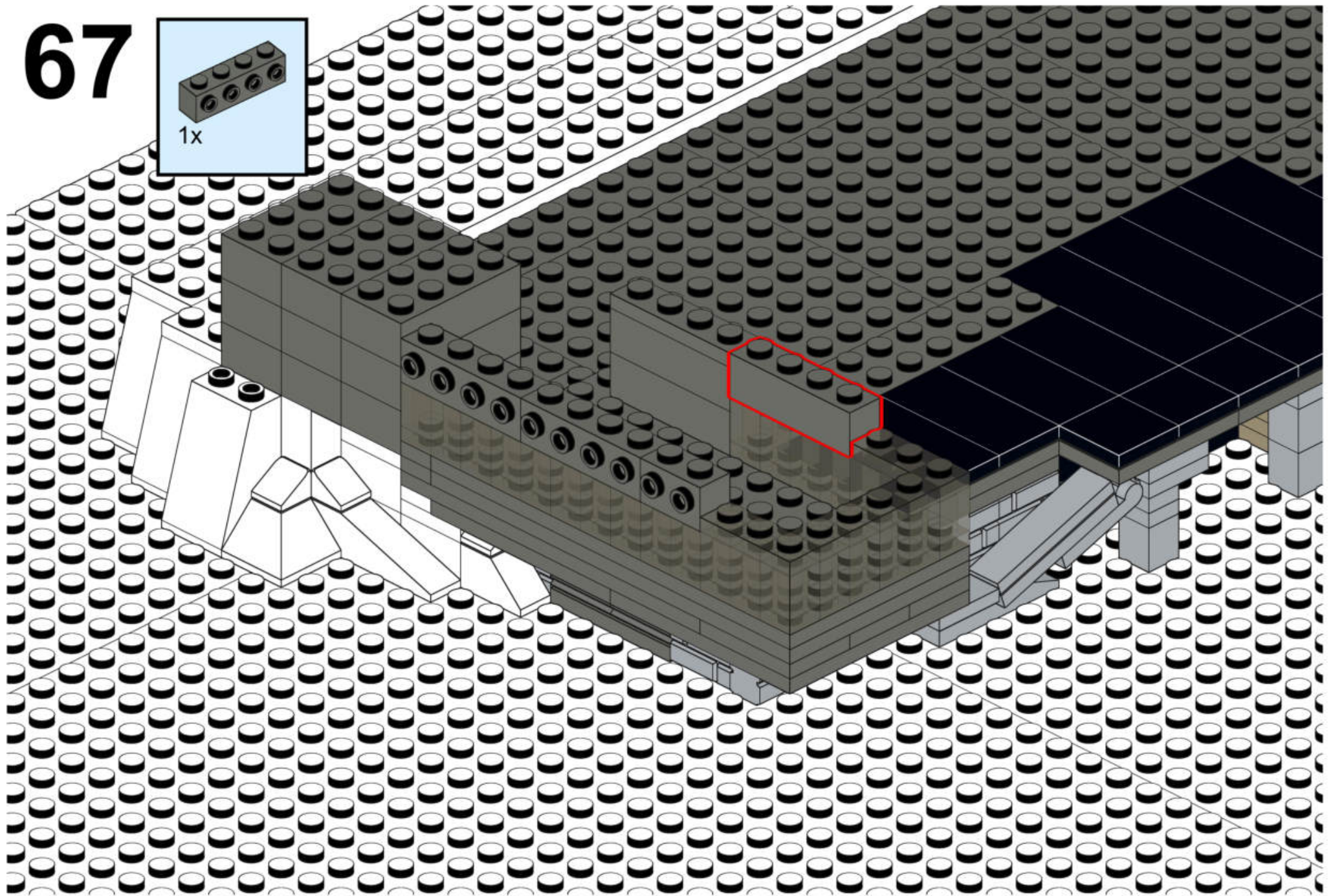
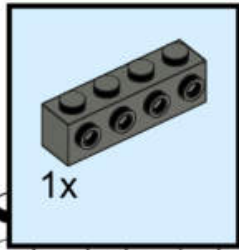



# 68

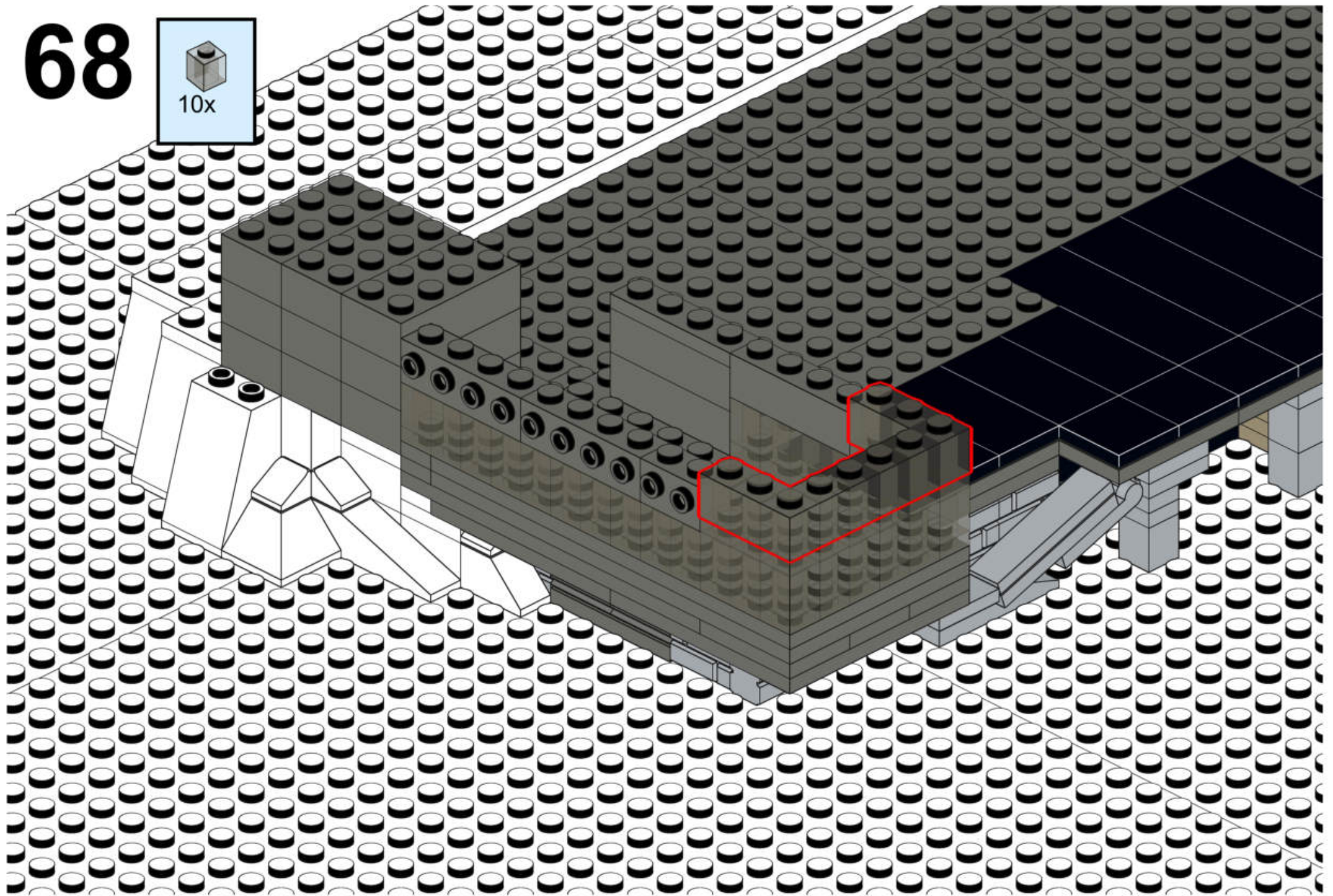
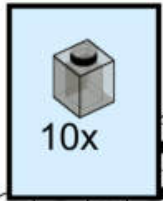



# 69

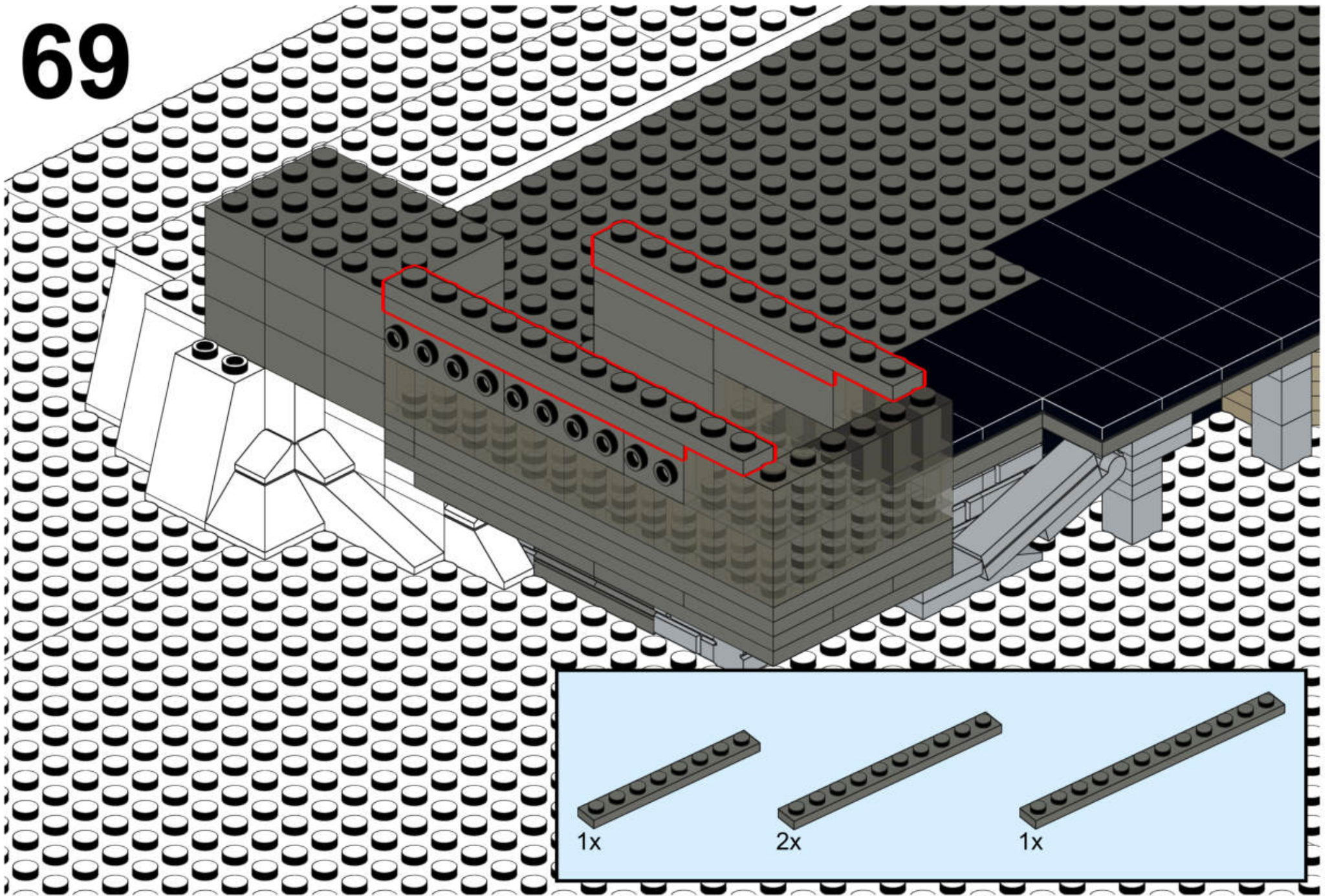



# 70

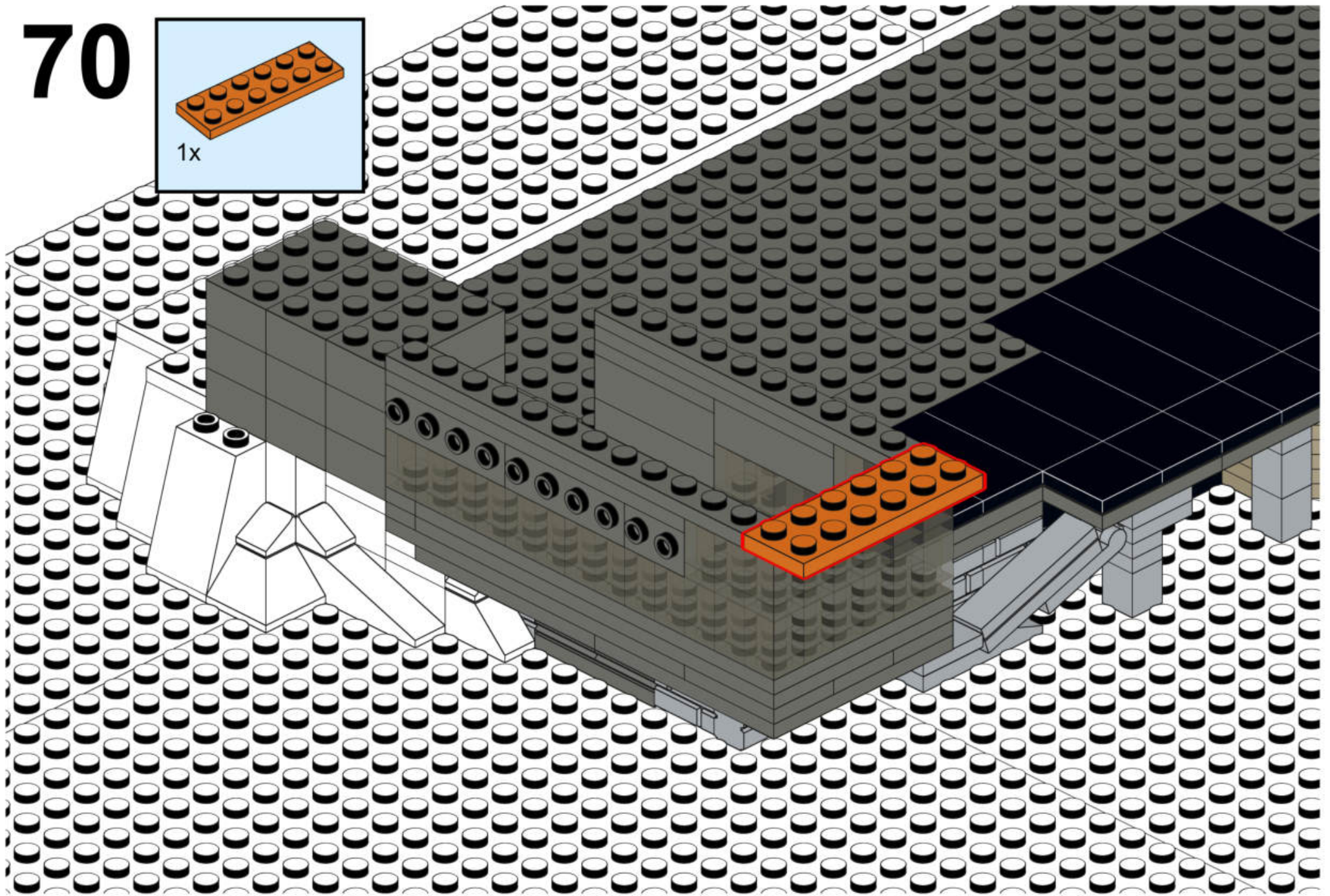
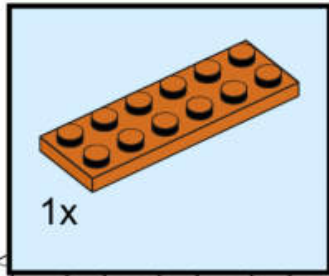



# 71

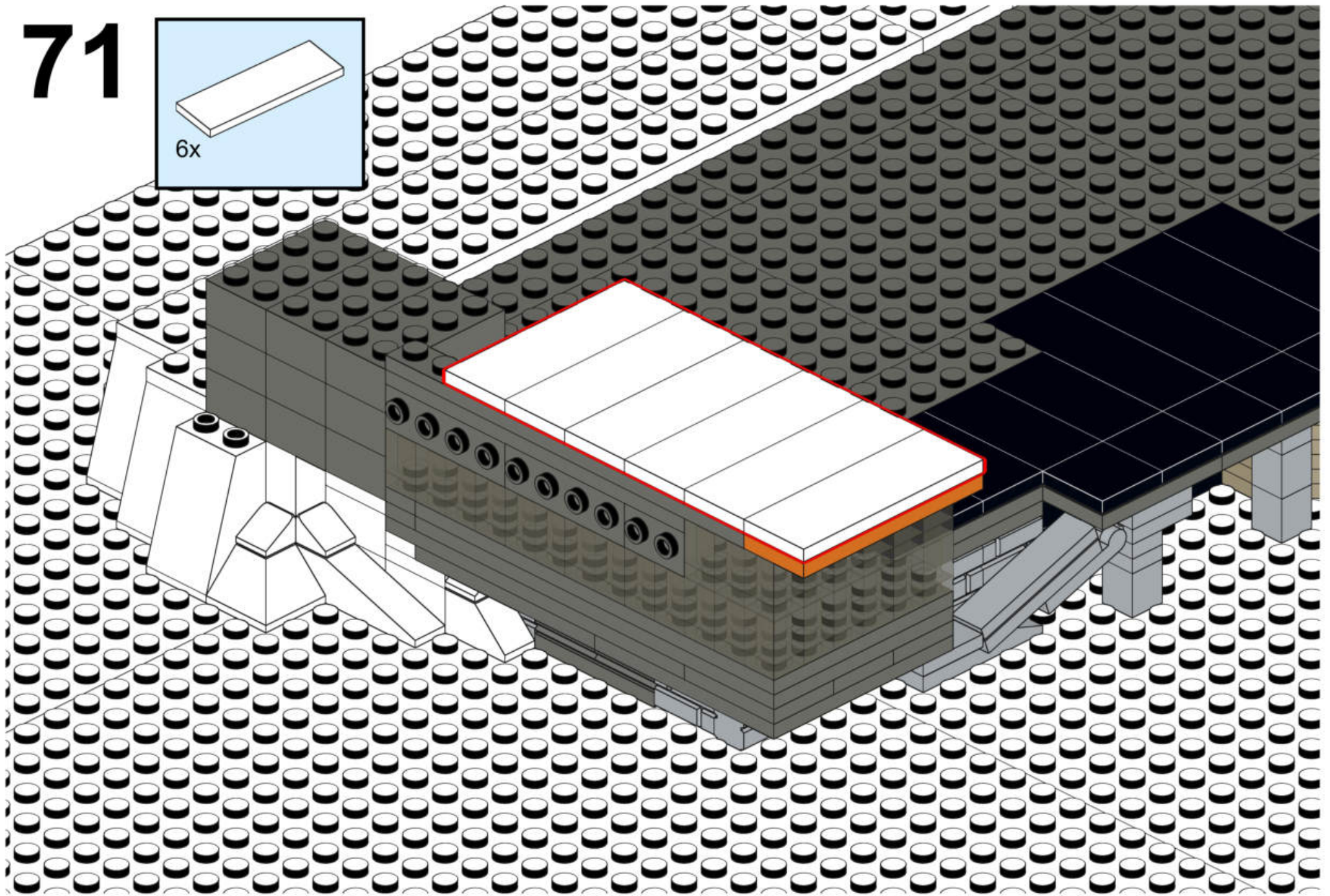
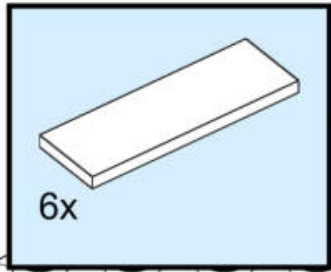



# 72

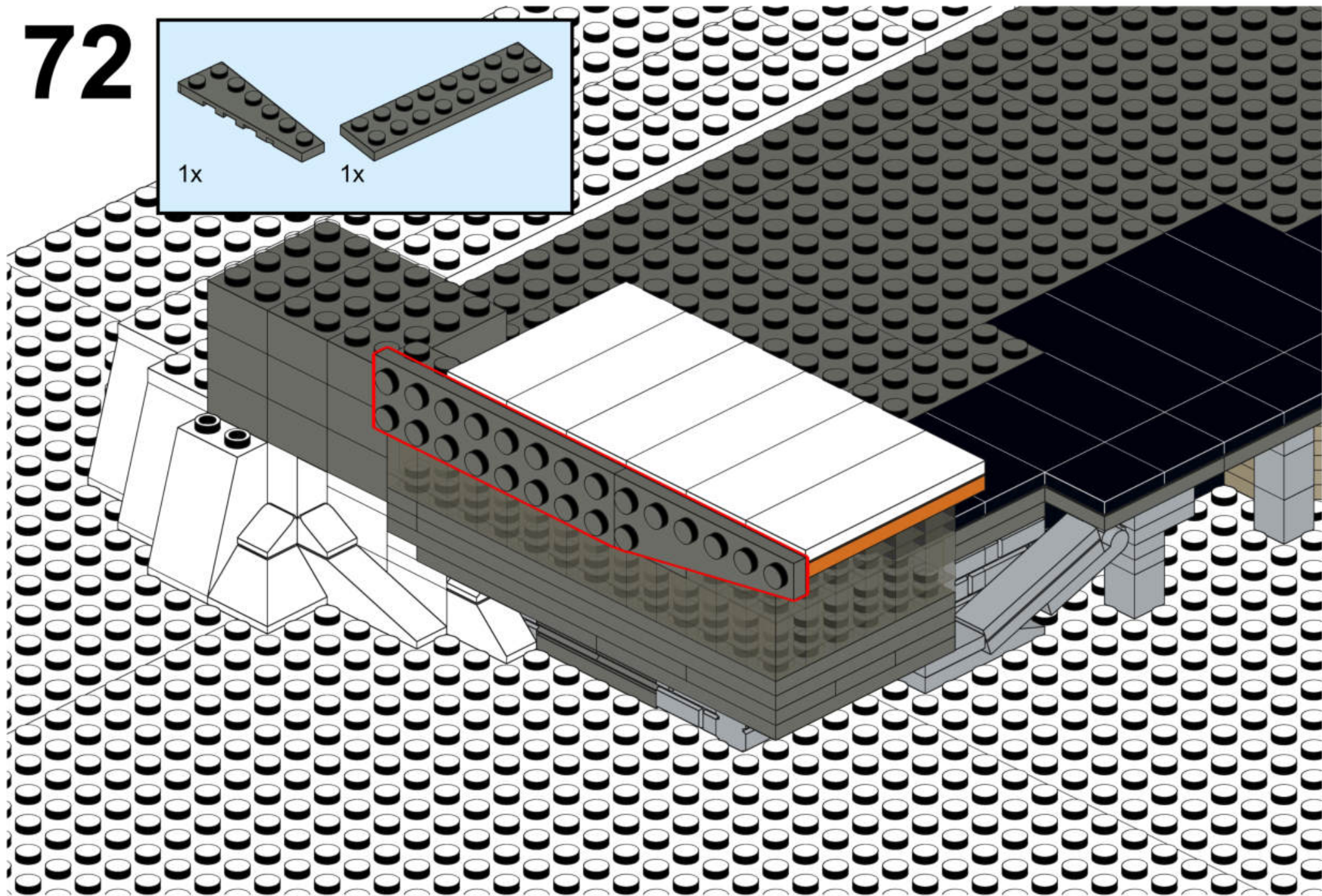
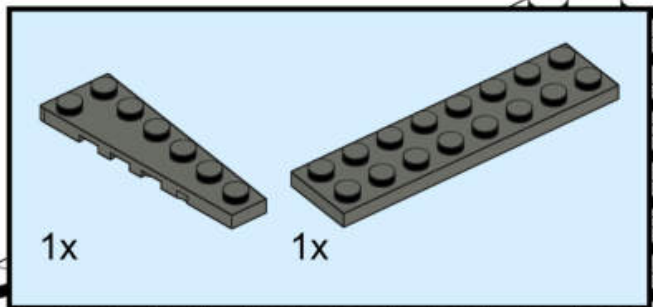



# 73

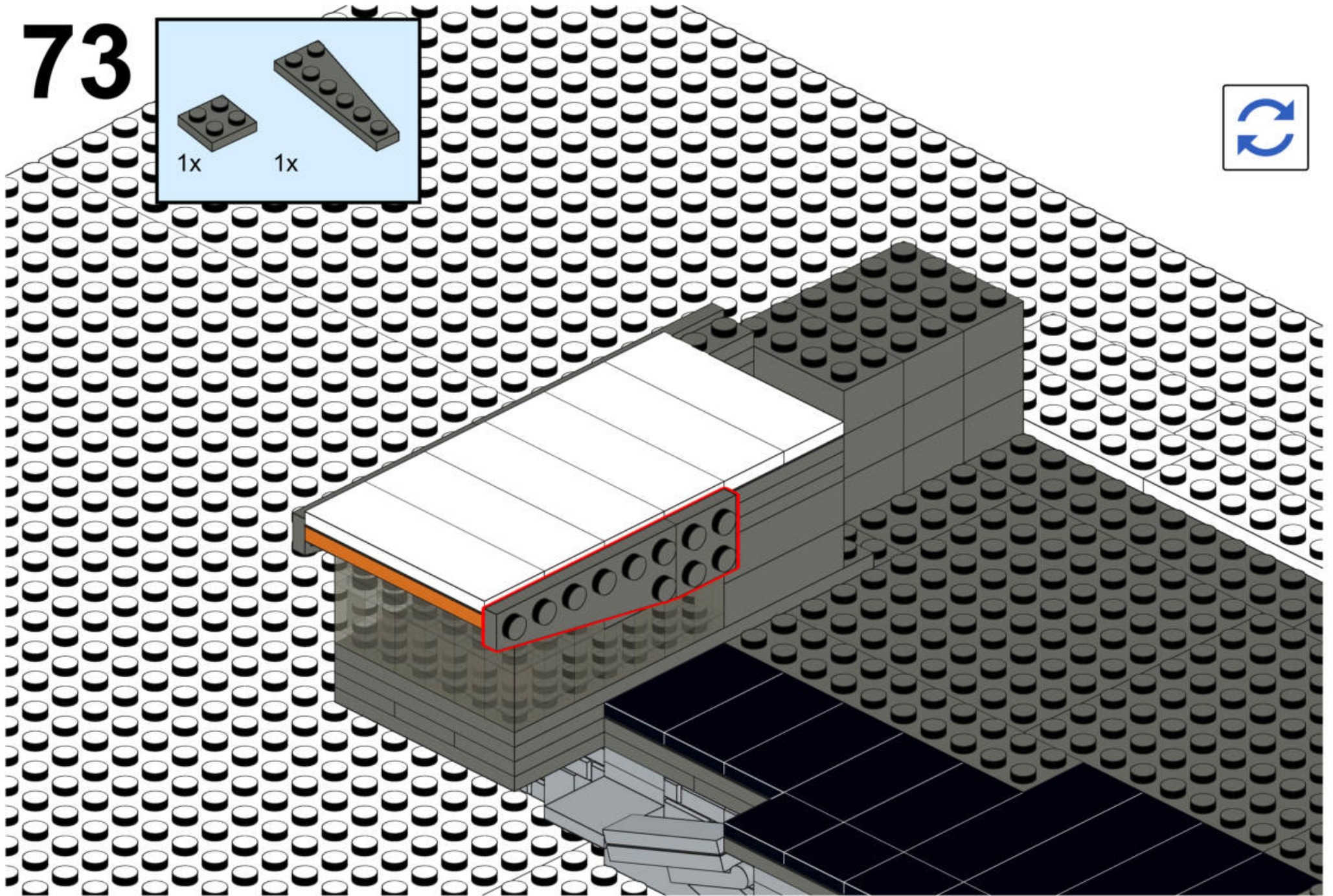
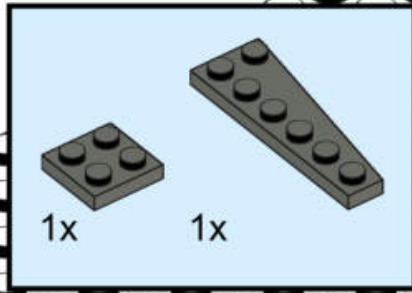



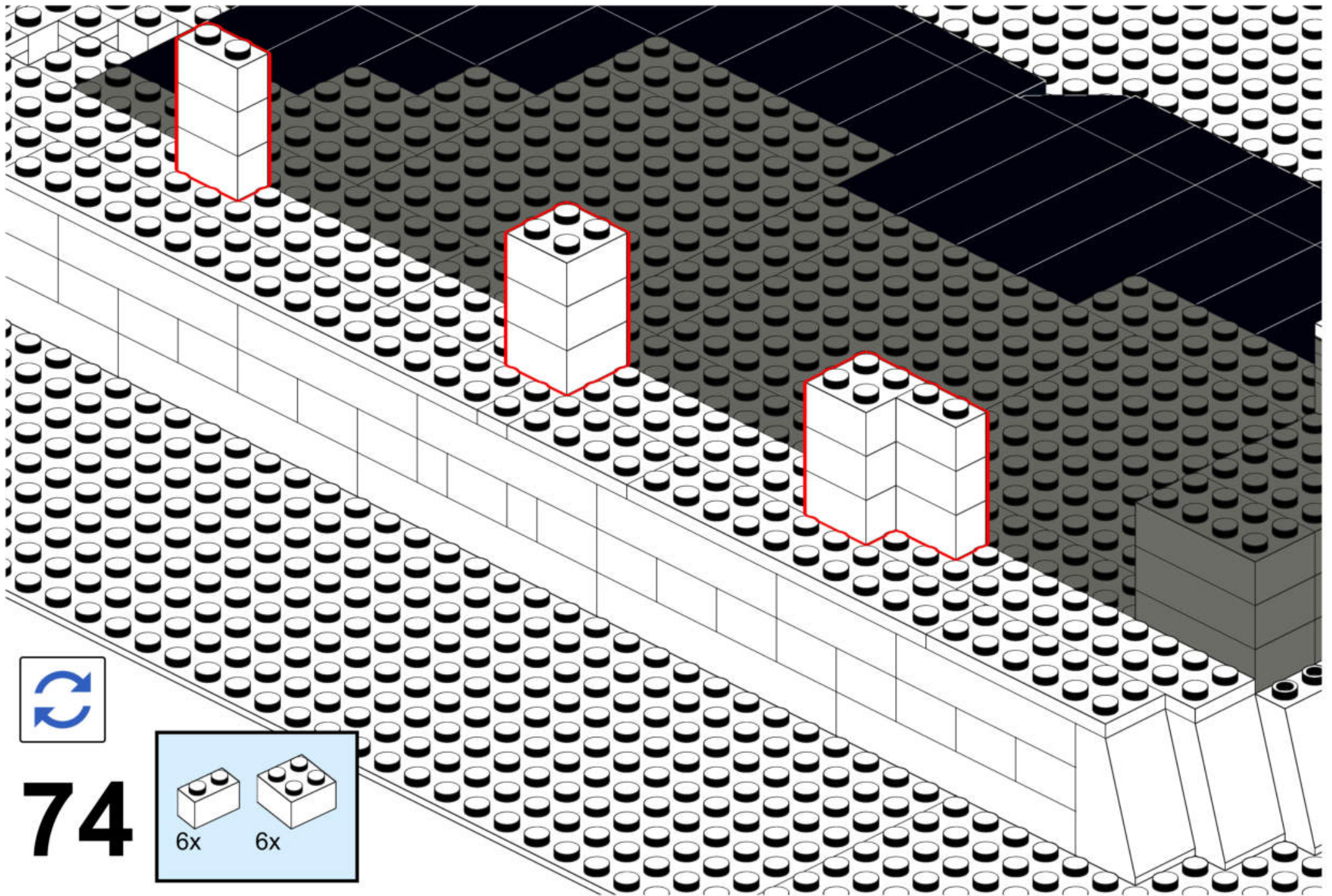

74

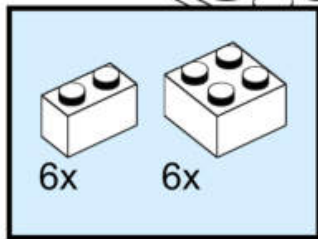



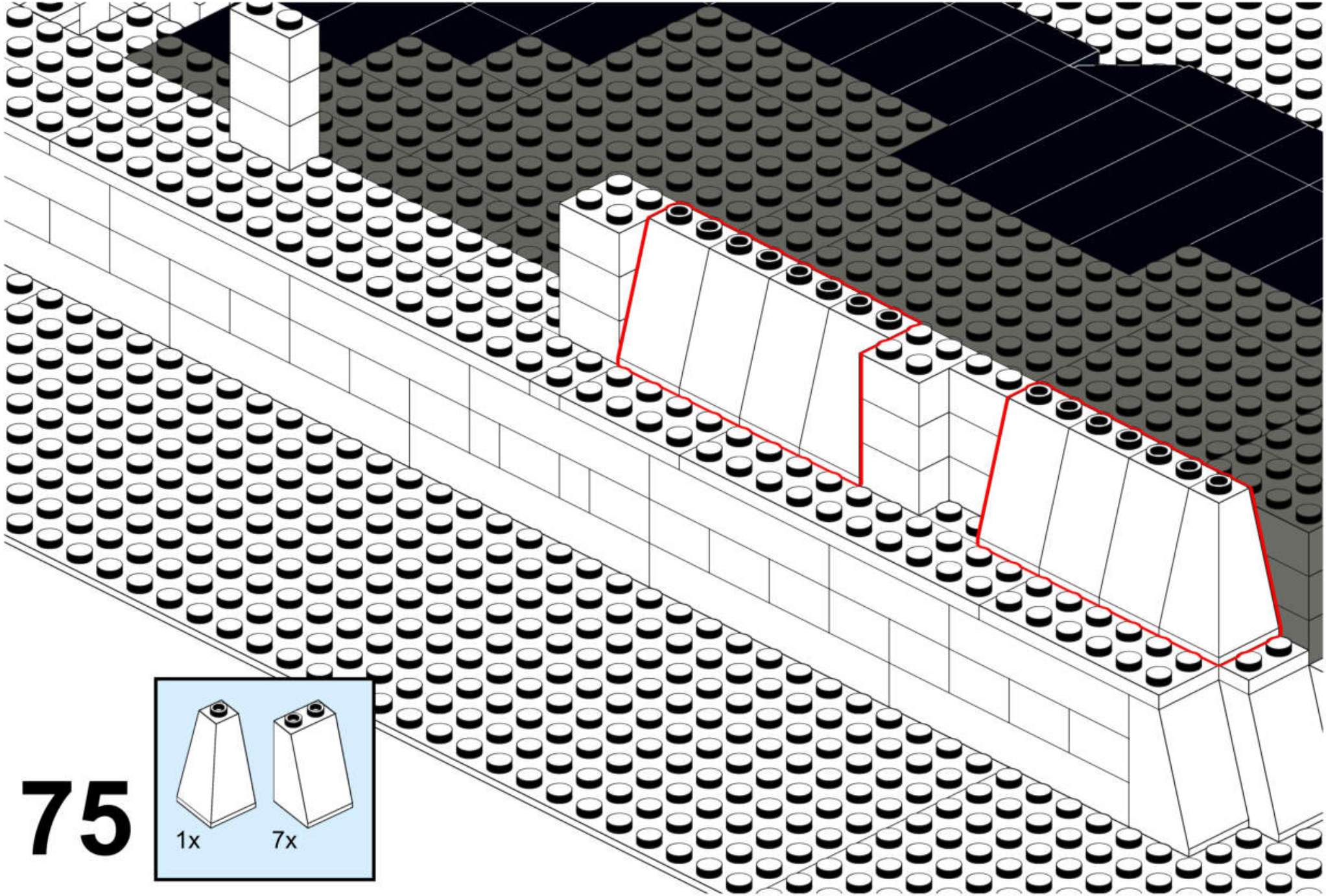

75

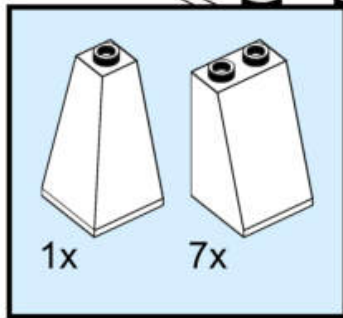



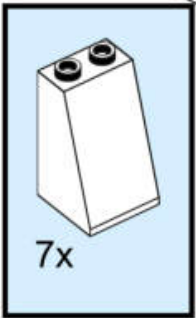
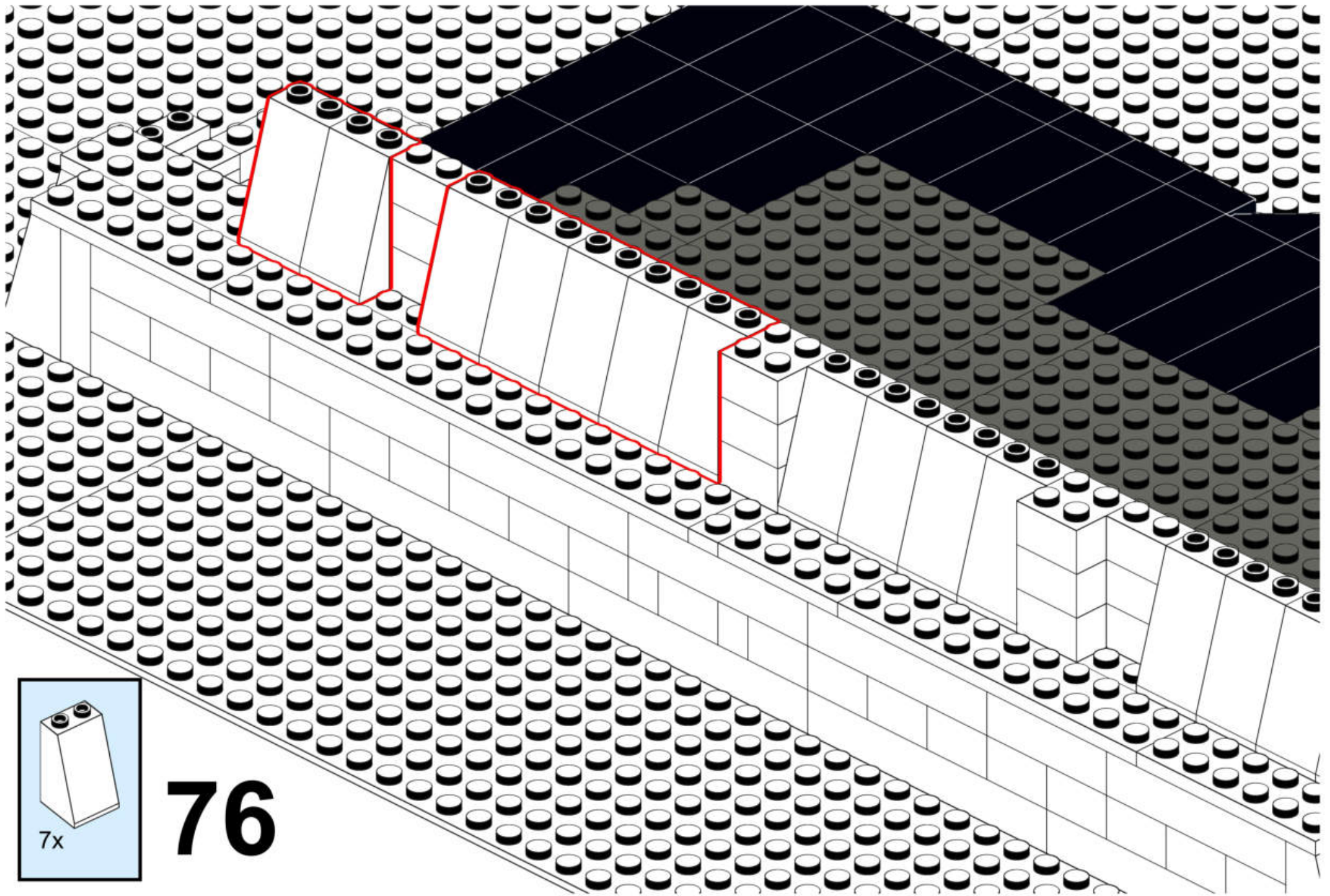

76



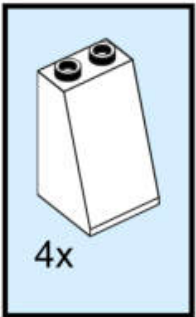
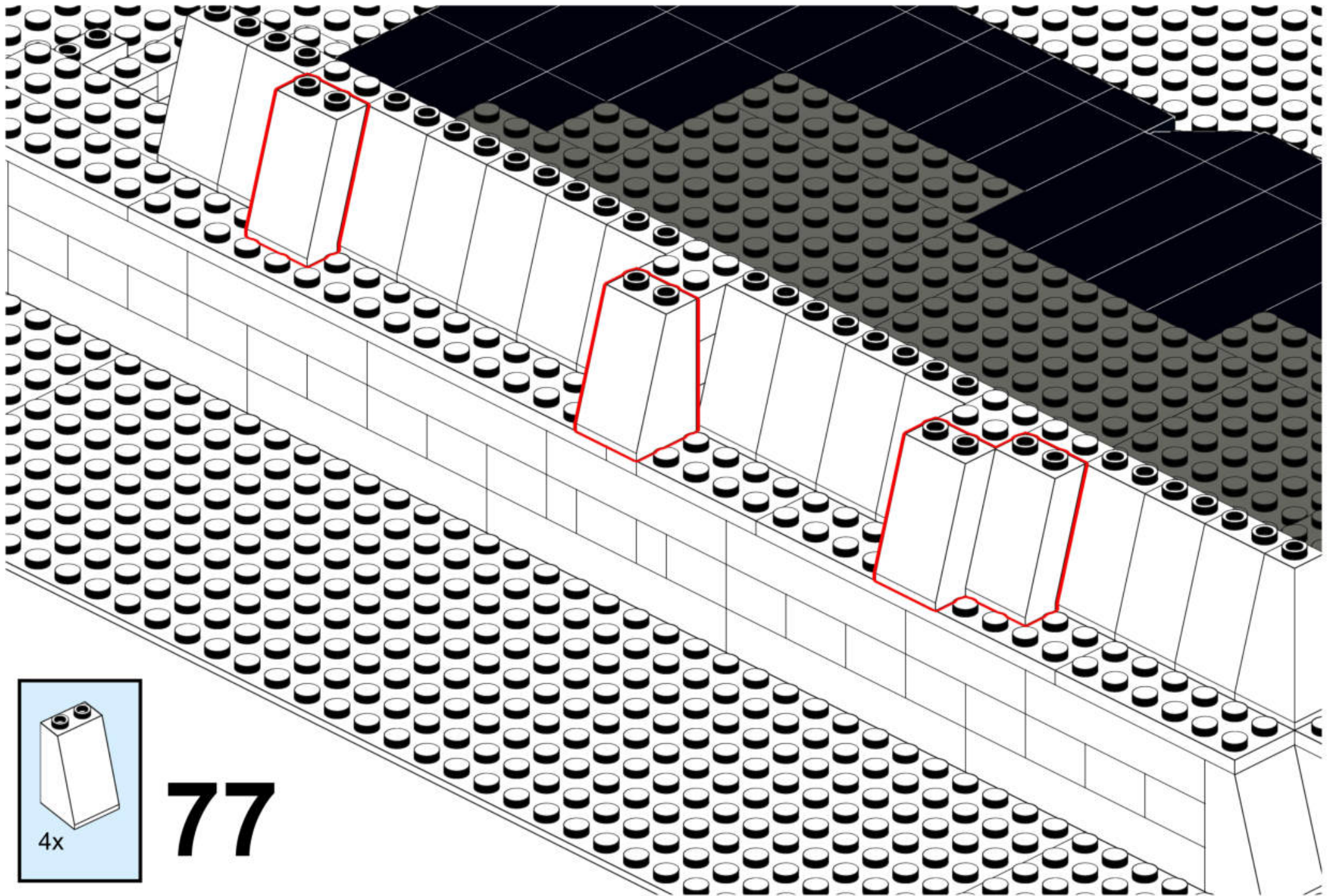

77



# 78

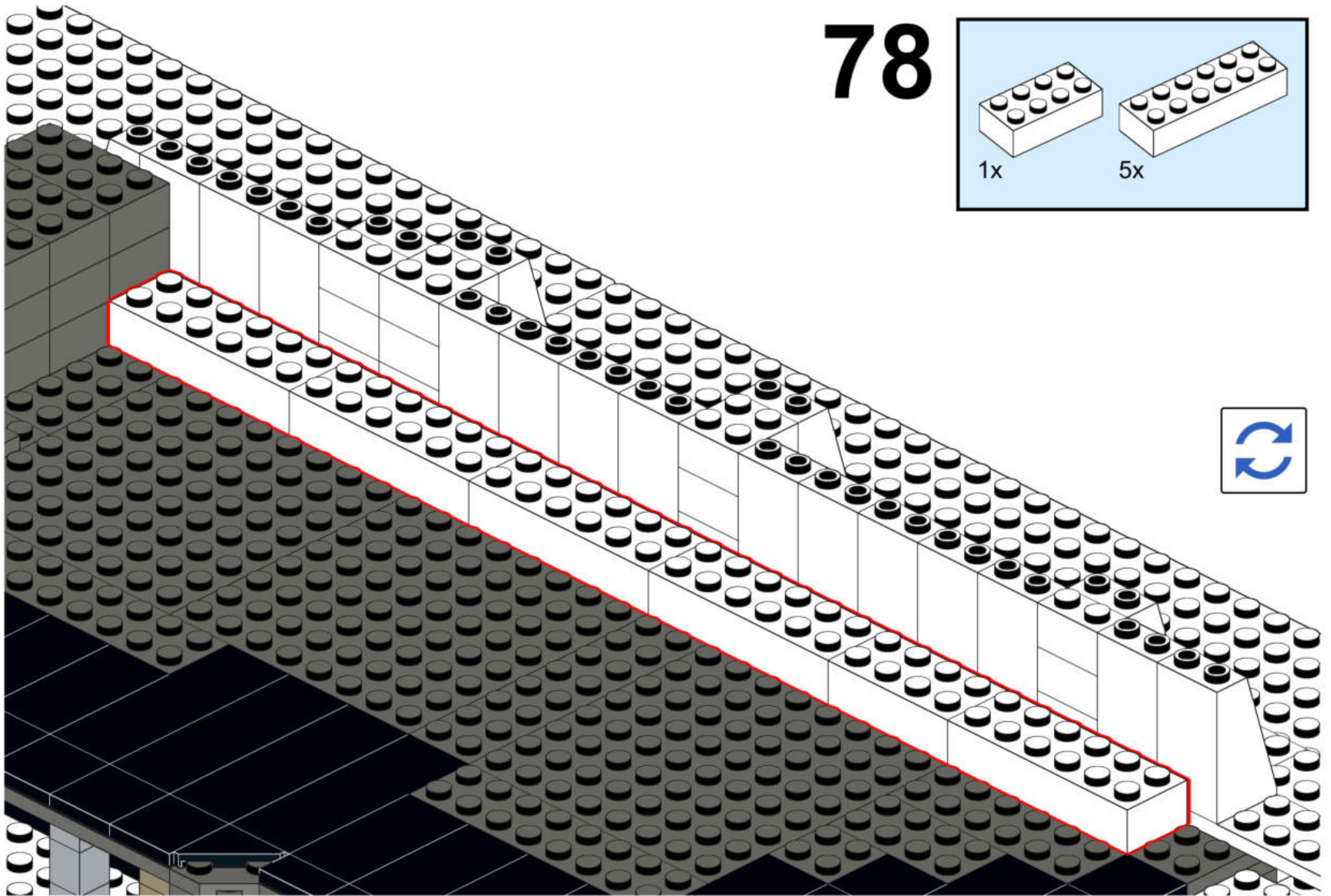
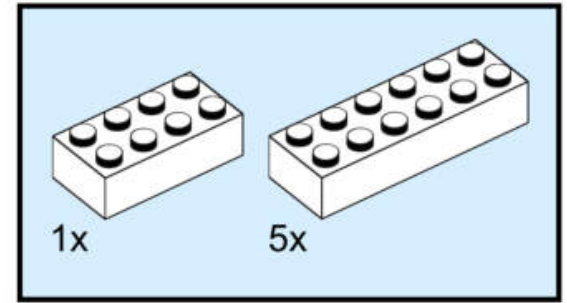



# 79

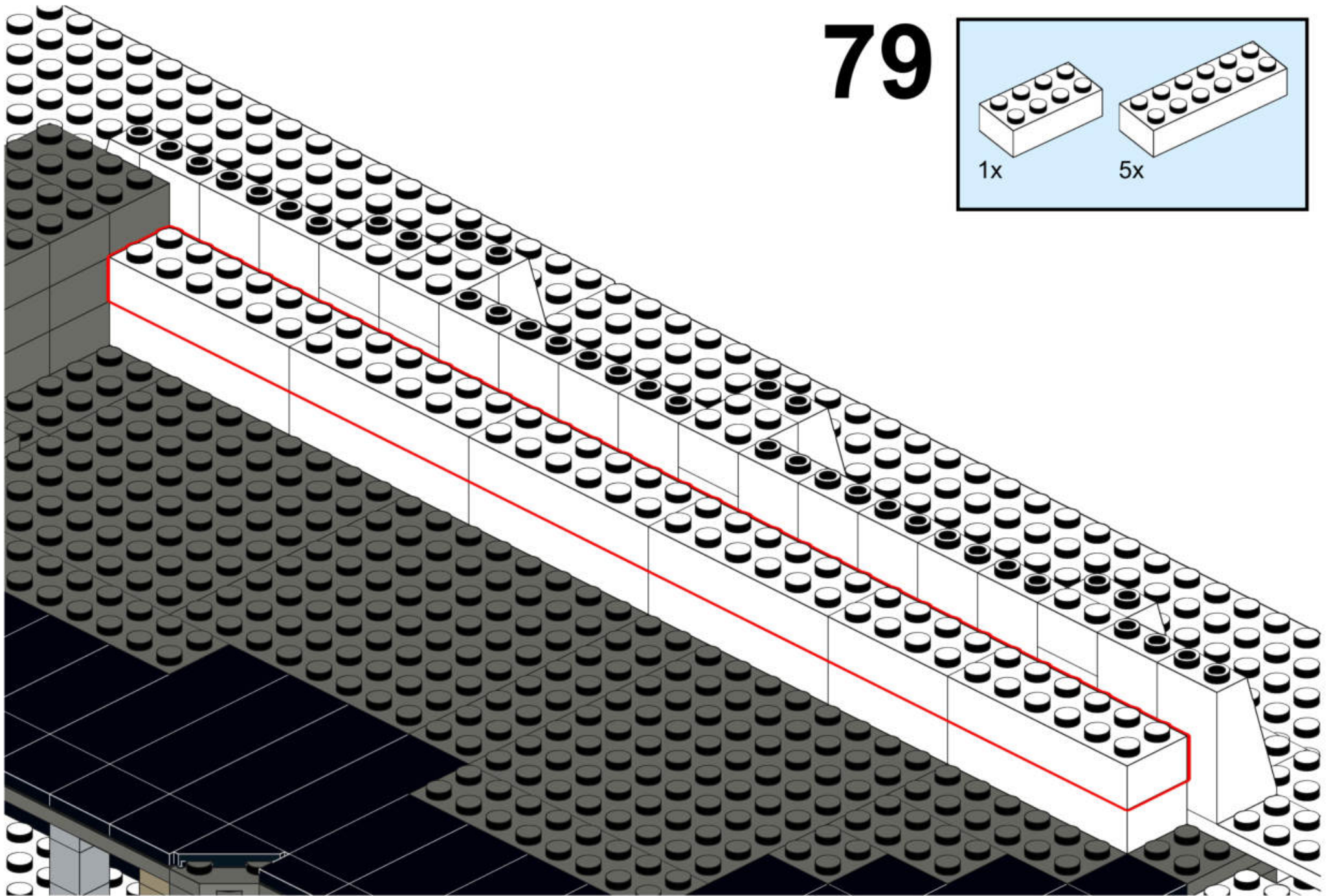
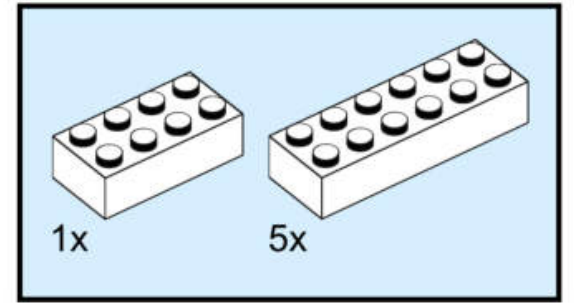



# 80

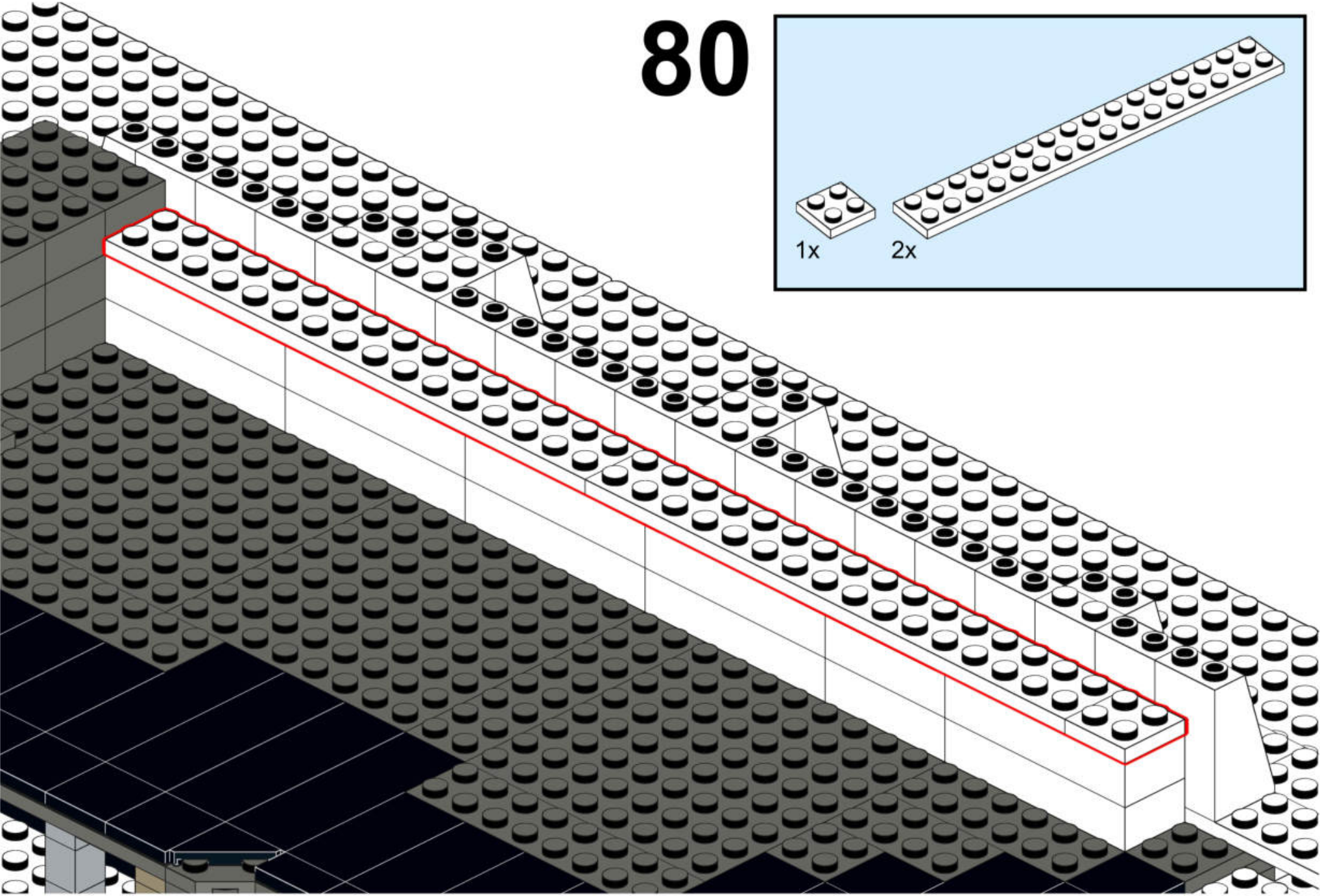
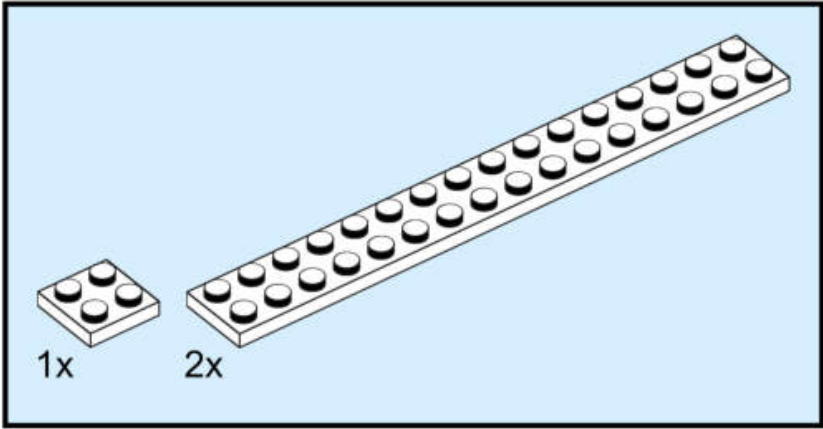



# 81

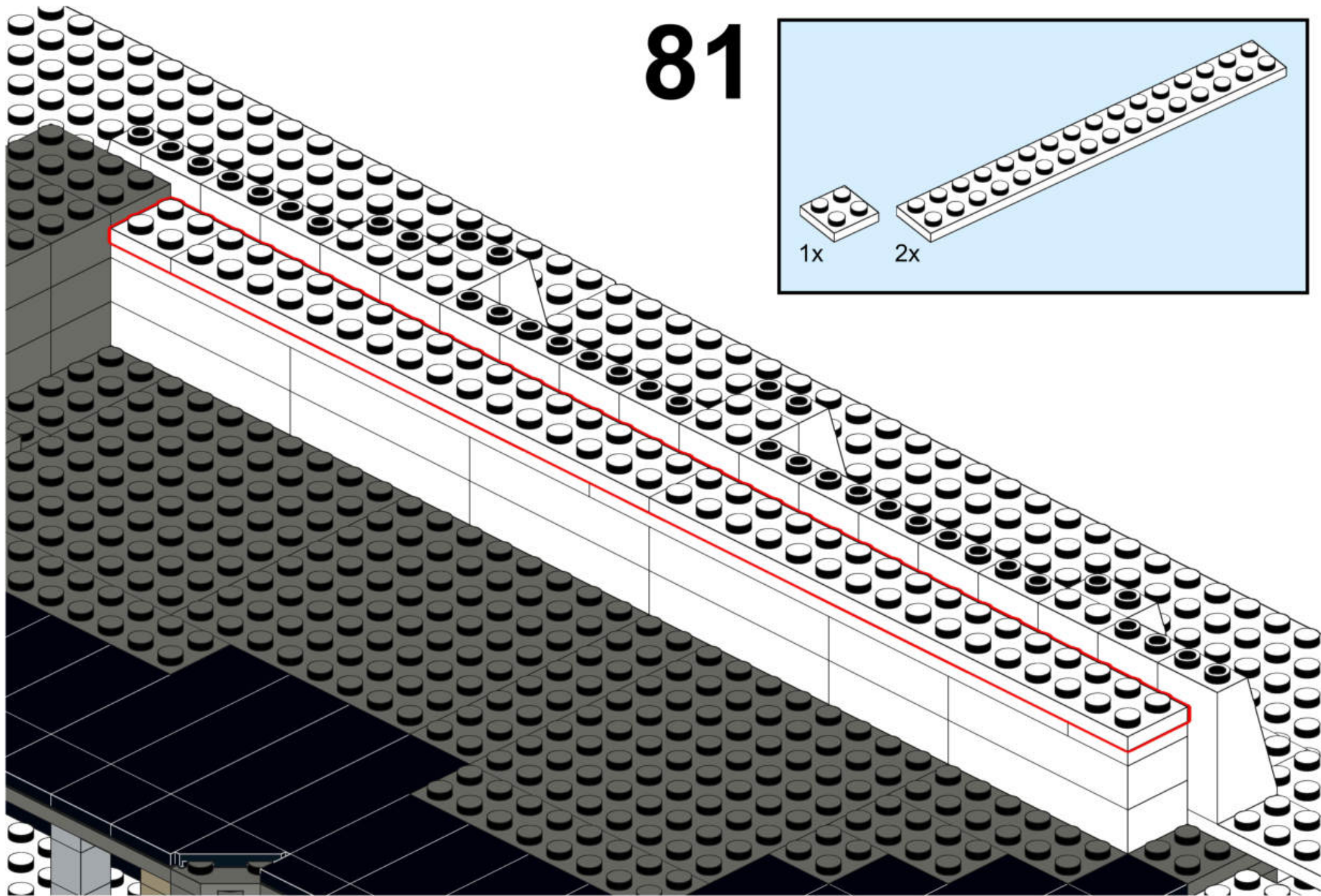
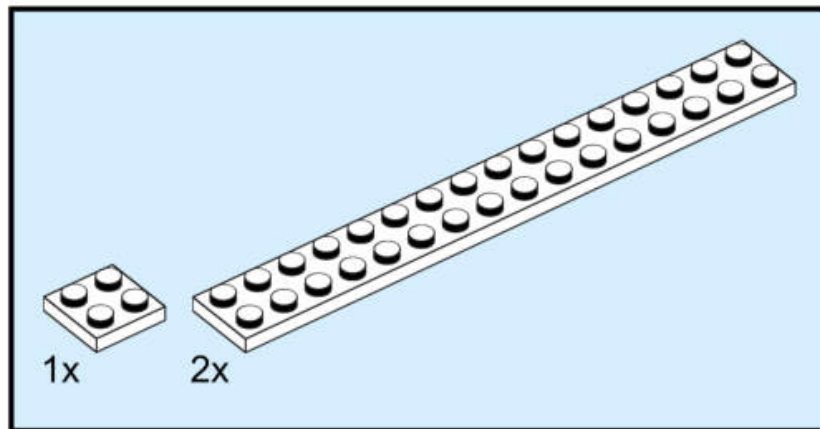



# 82

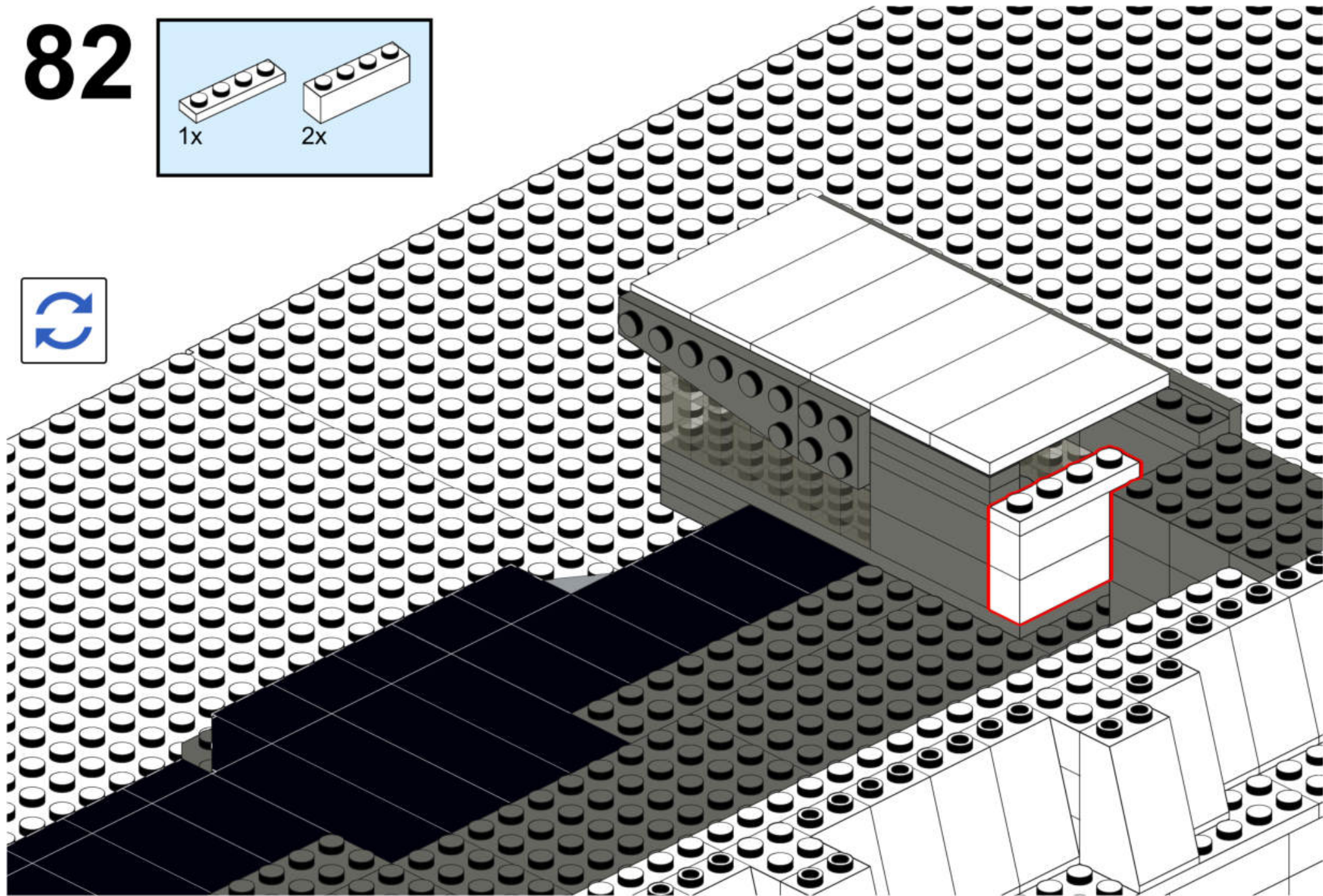
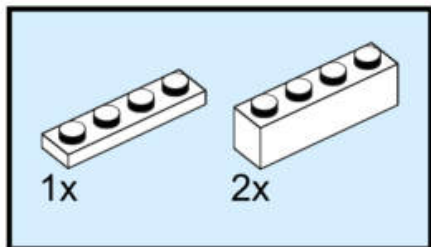



# 83

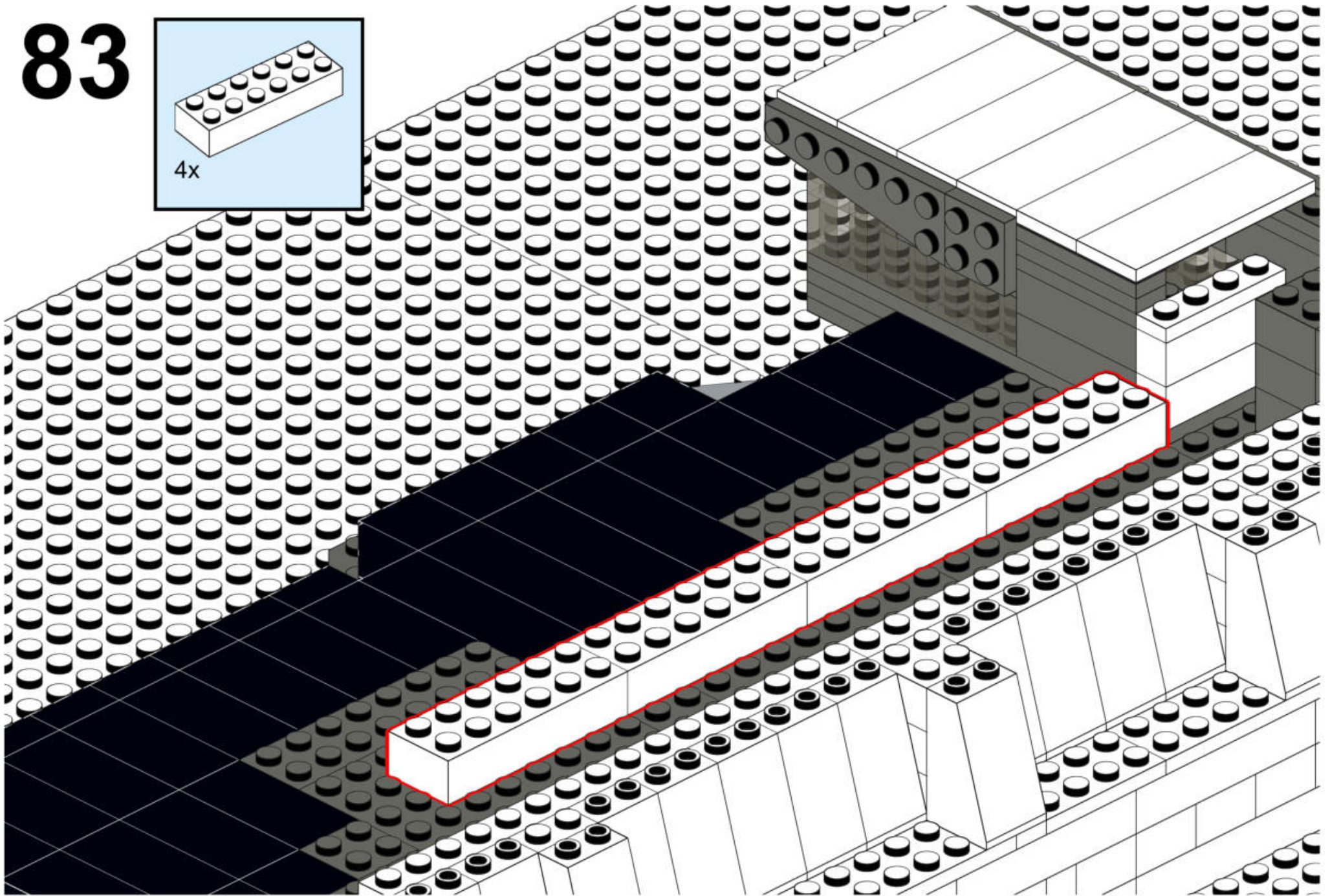
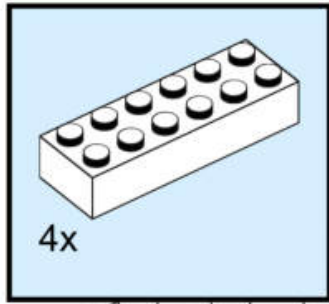



# 84

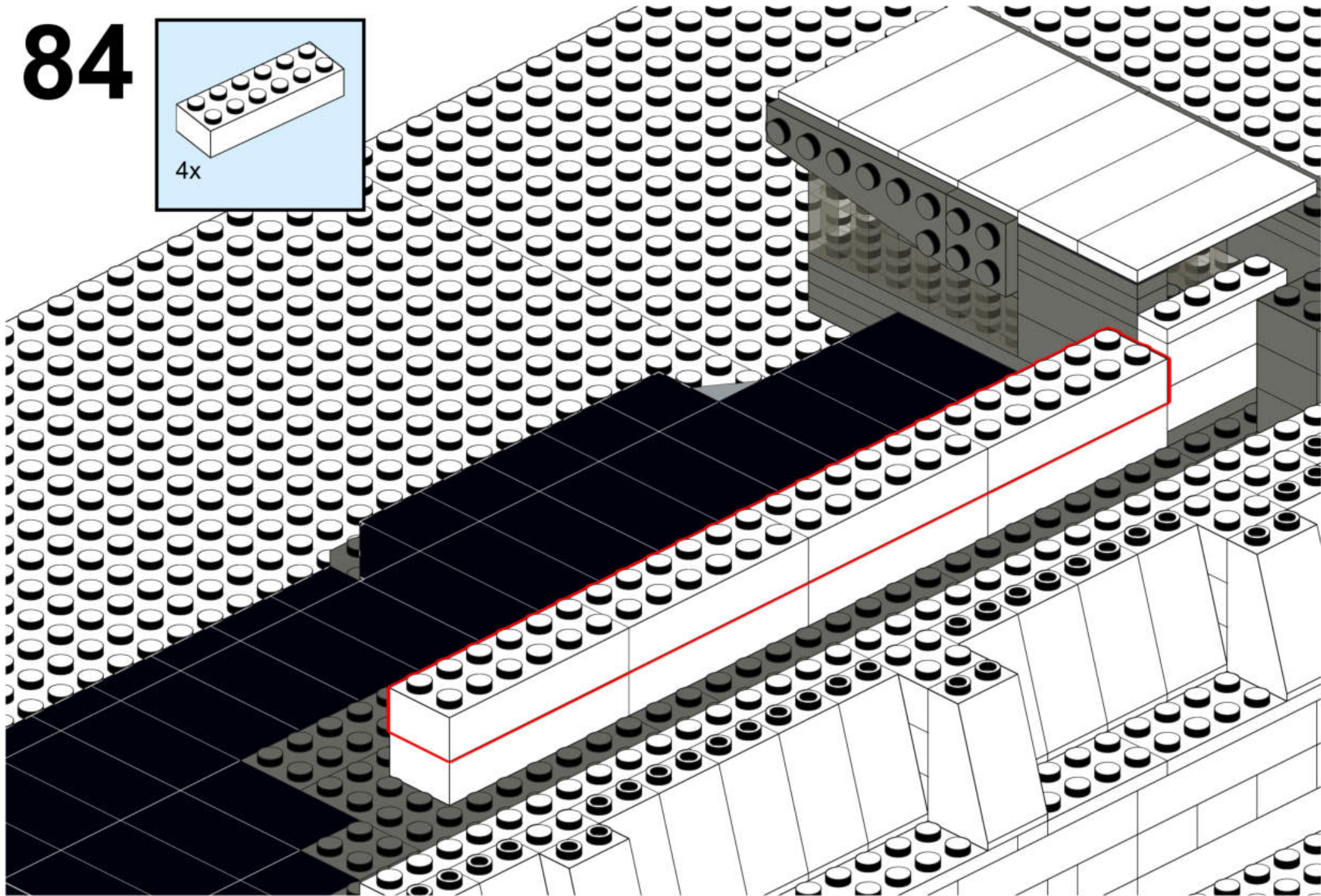
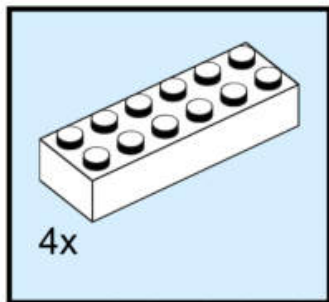



# 85

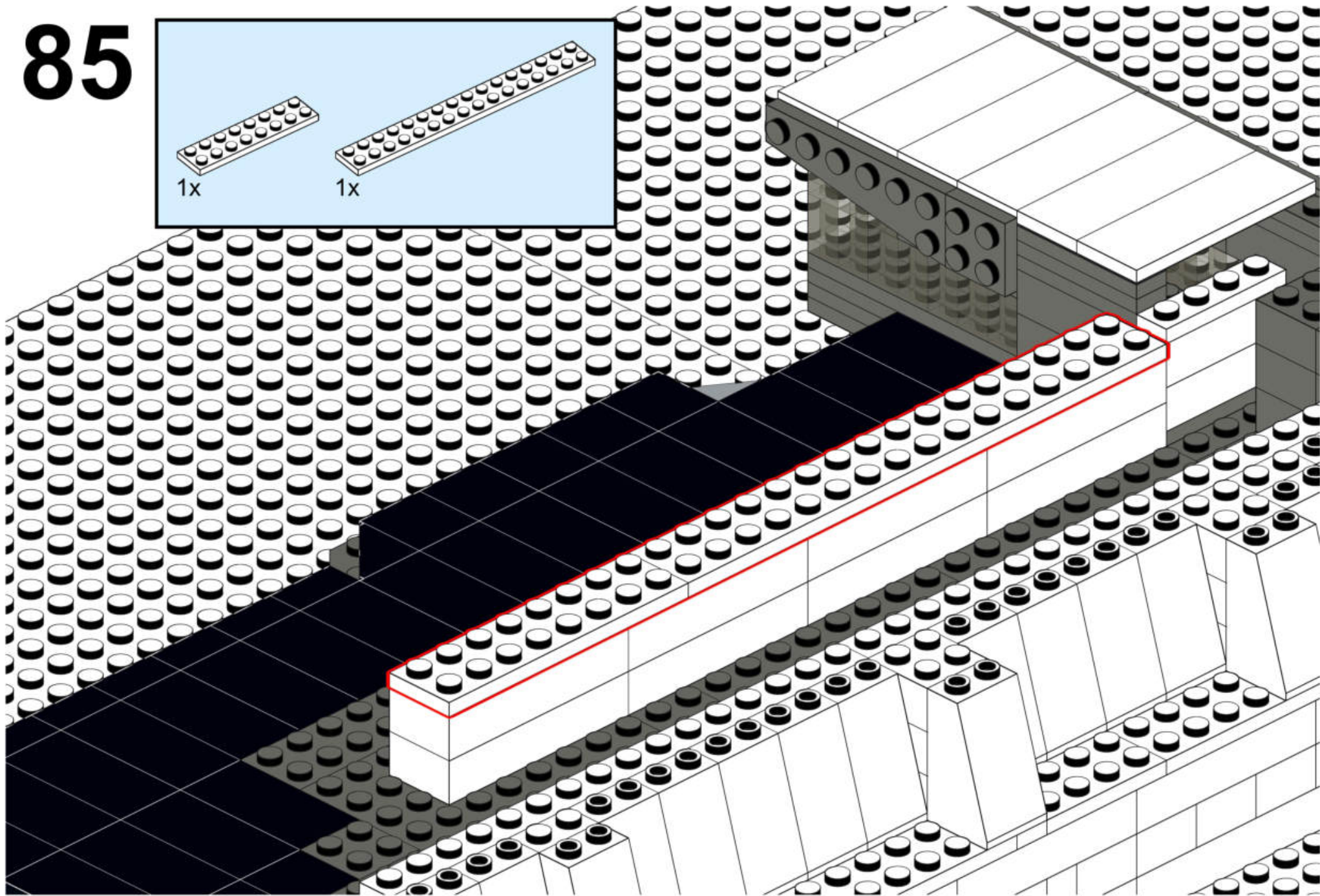
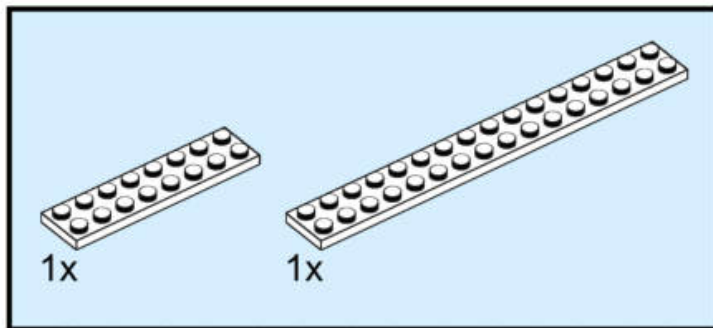



# 86

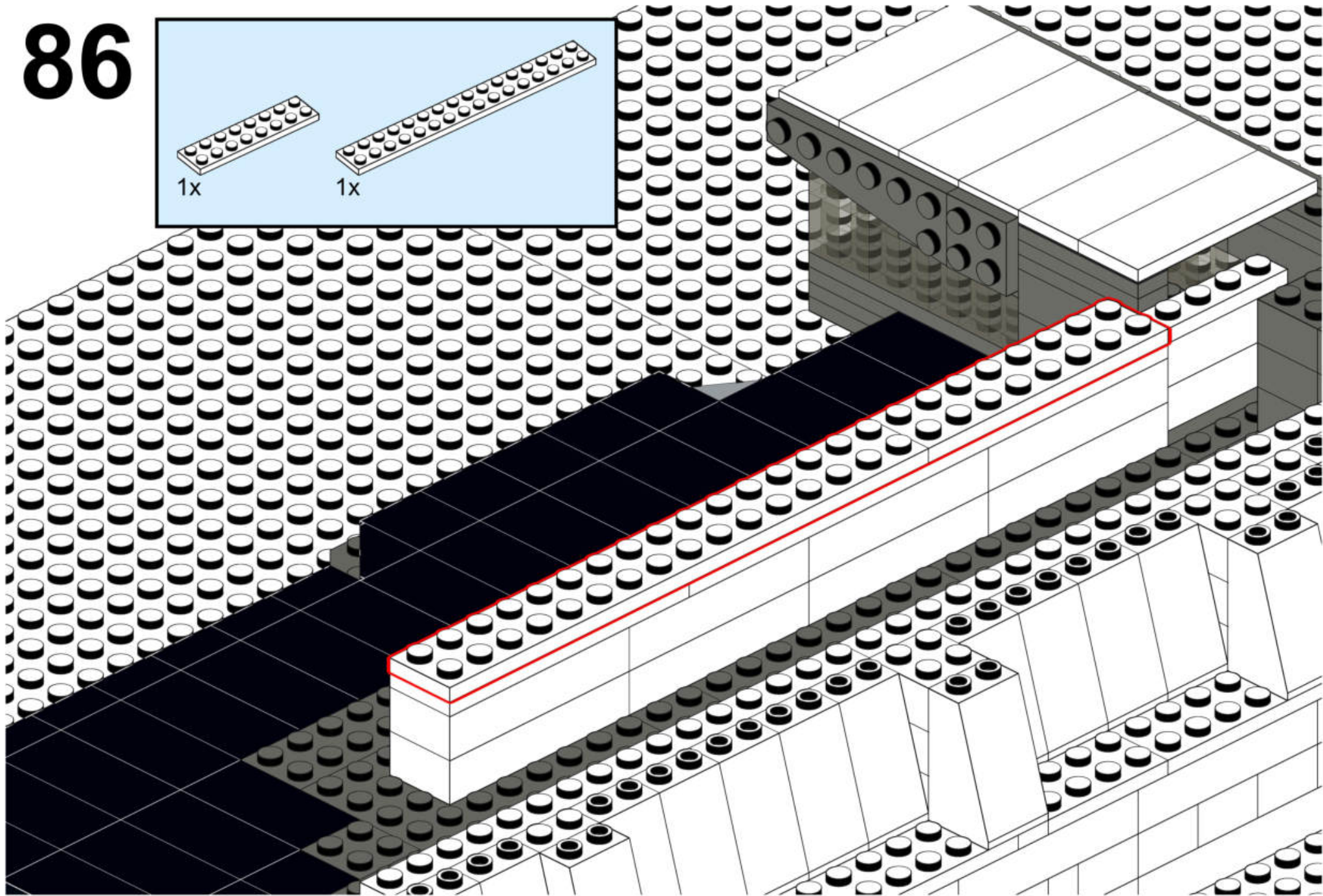
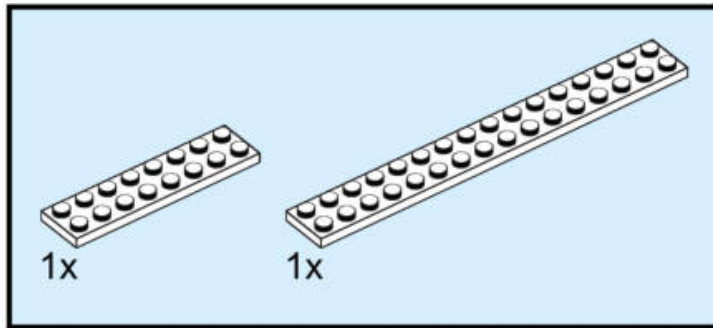



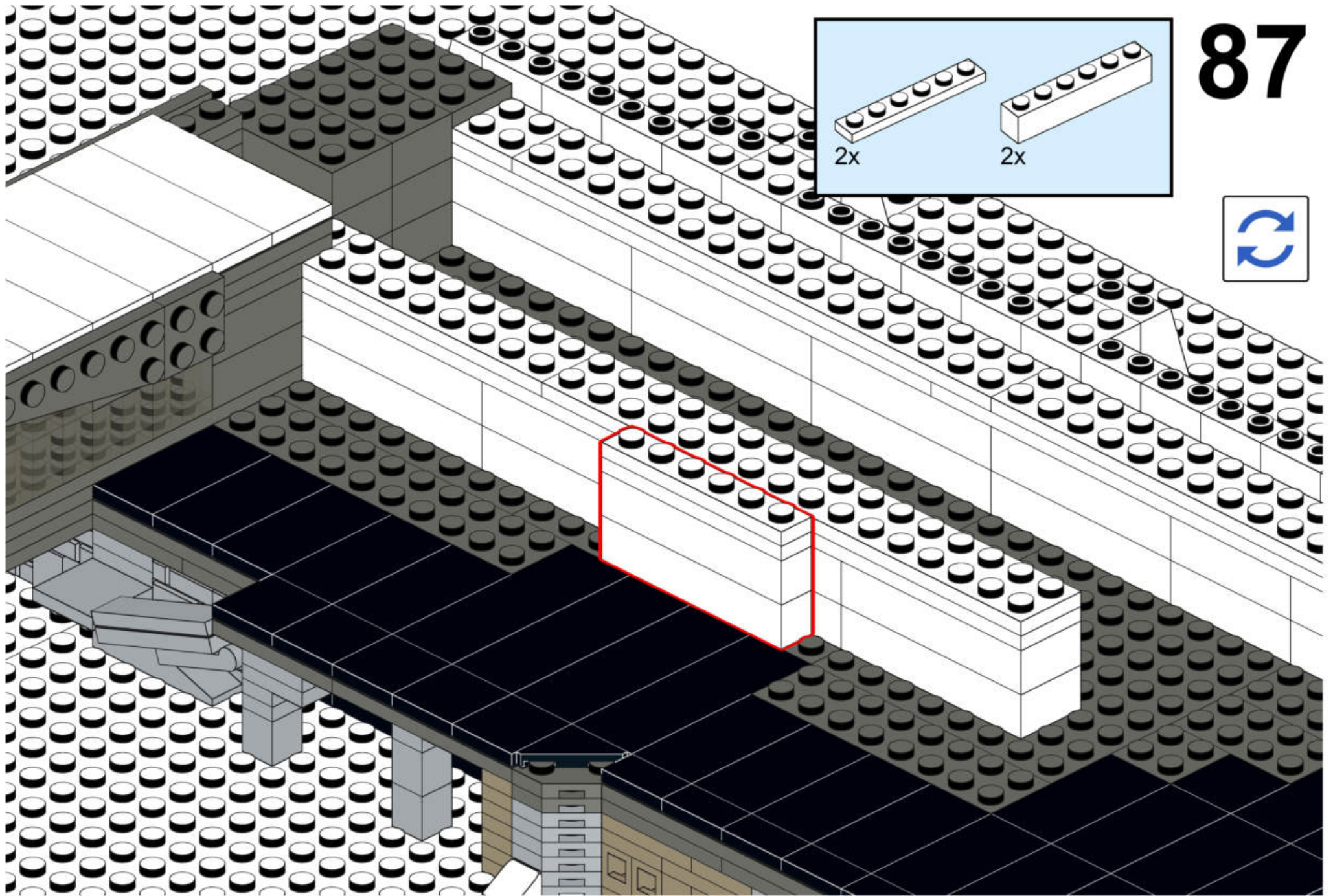



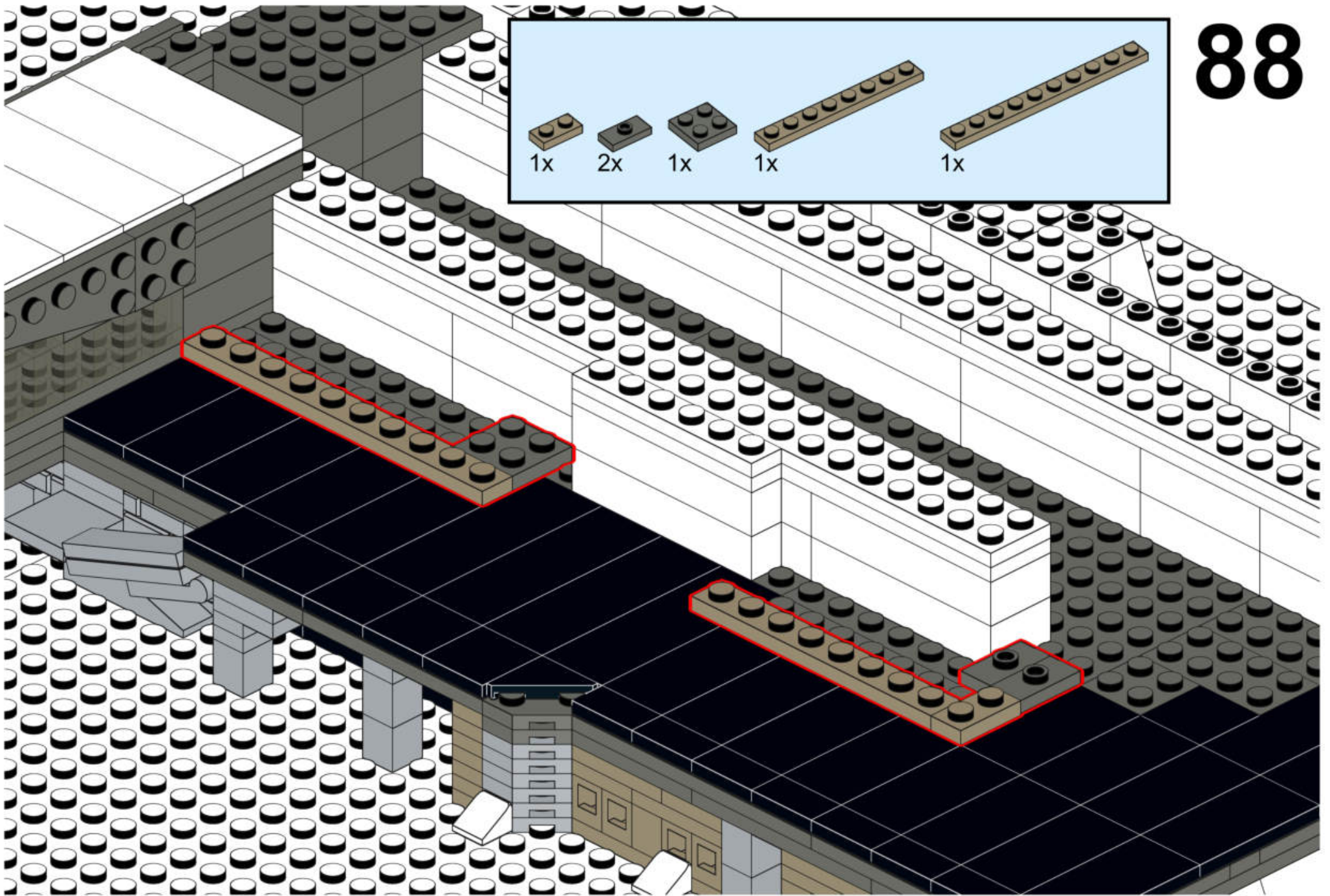
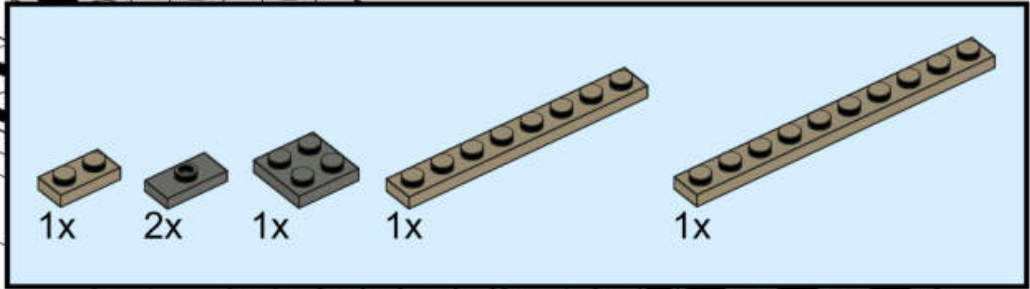



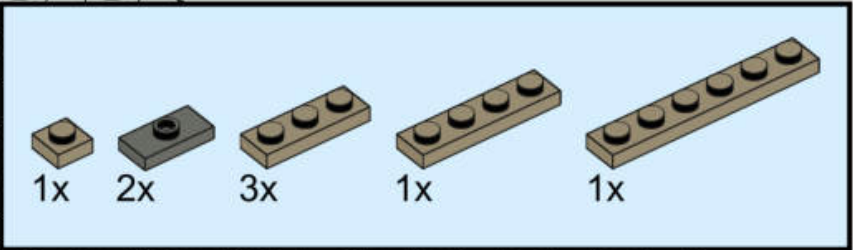

1x 2x 3x 1x 1x

This inset box shows the parts list for step 89. It contains five items: a 1x1 brown Technic brick with a hole, two 1x2 brown Technic bricks with holes, three 1x3 brown Technic bricks with holes, one 1x4 brown Technic brick with holes, and one 1x5 brown Technic brick with holes. Each item is accompanied by its quantity.

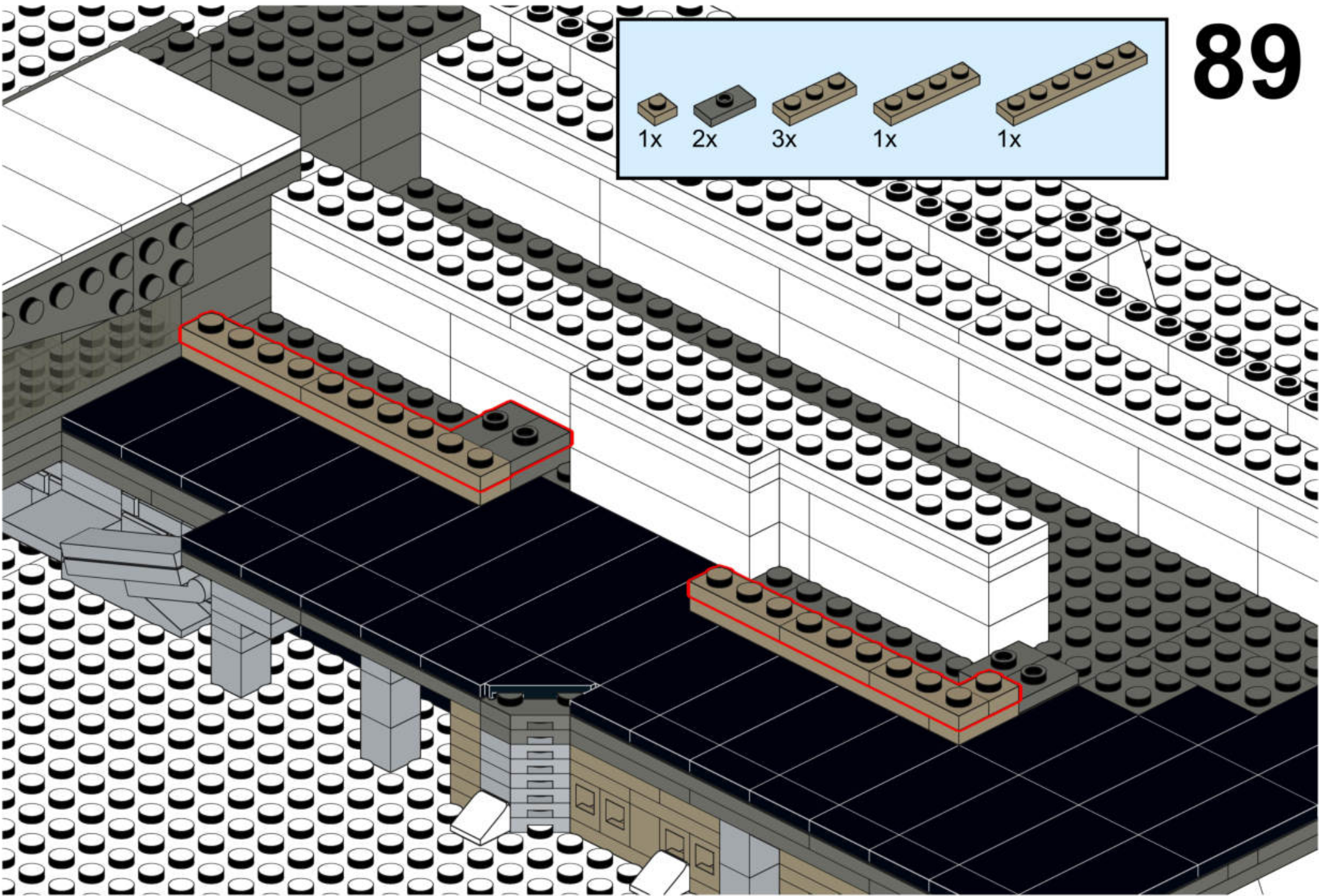



# 90

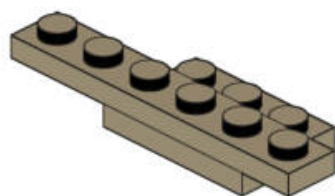
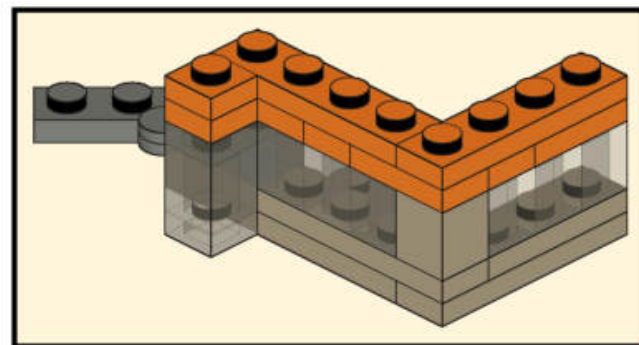
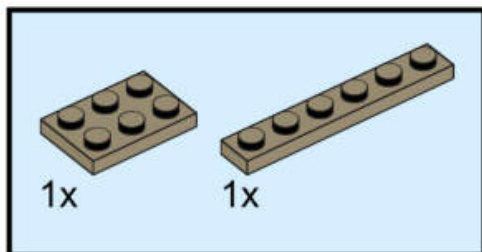



# 91

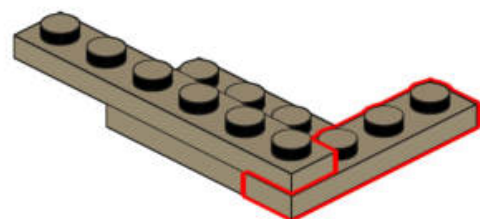
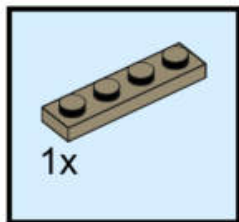



92

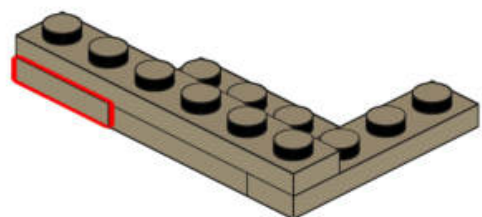
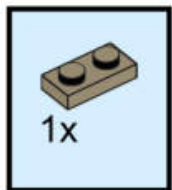



93

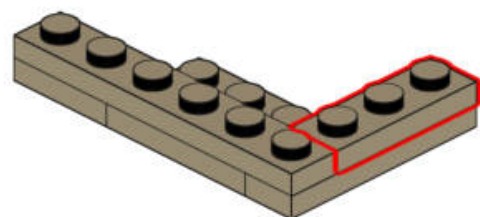
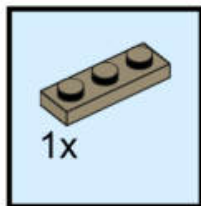



# 94

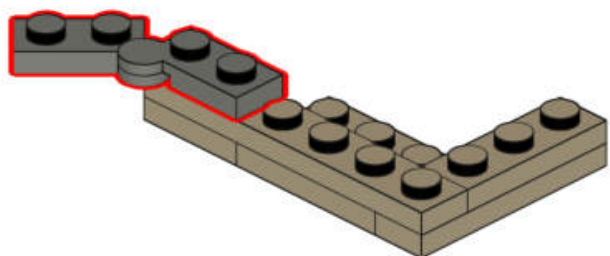
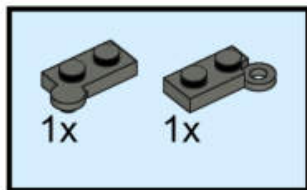



# 95

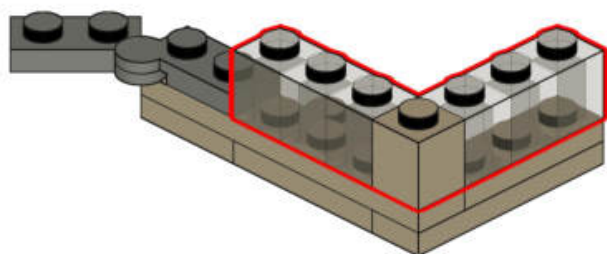
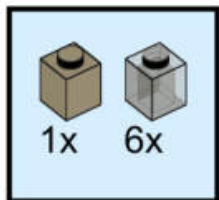



96

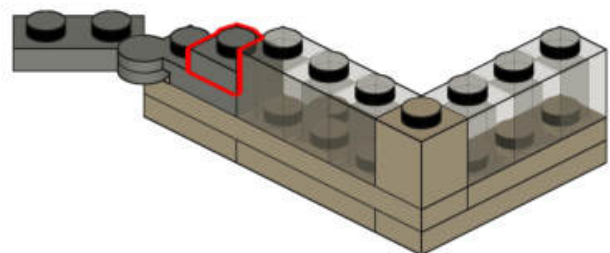
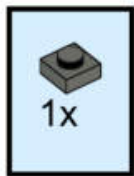



# 97

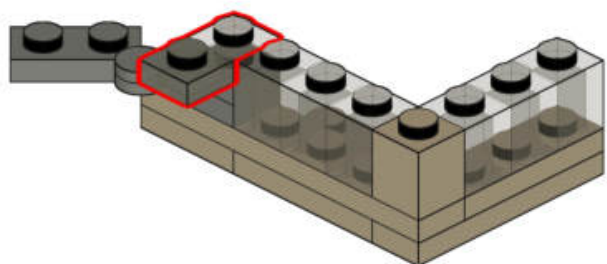
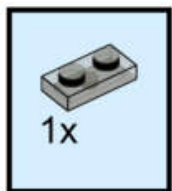



# 98

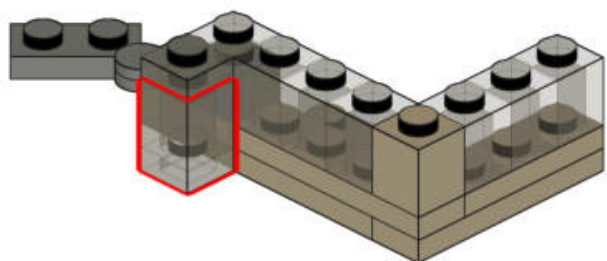
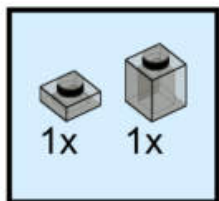



# 99

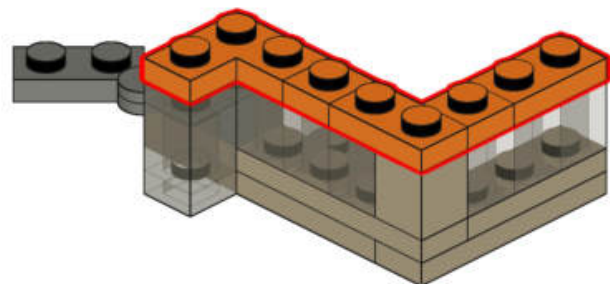
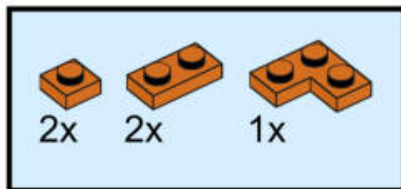



# 100

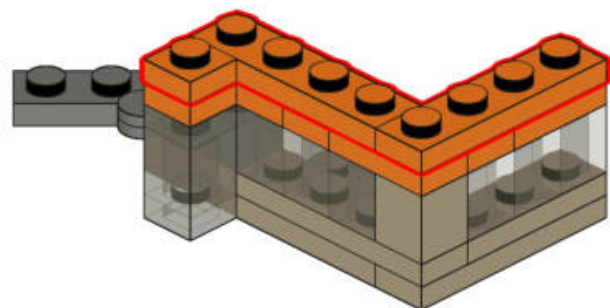
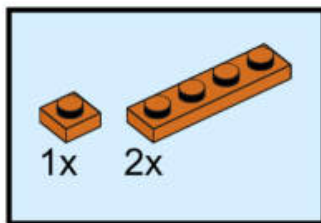



# 101

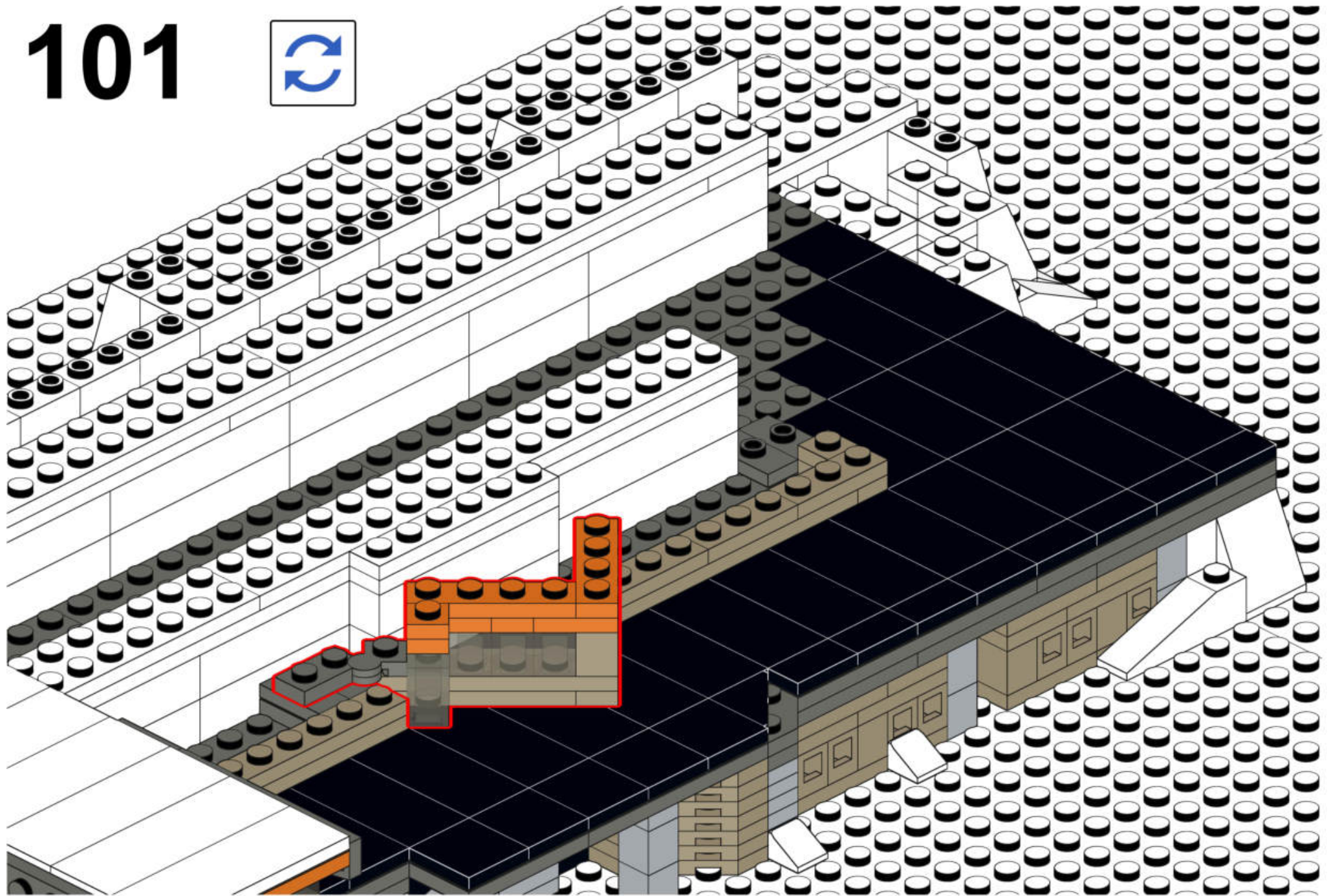



# 102

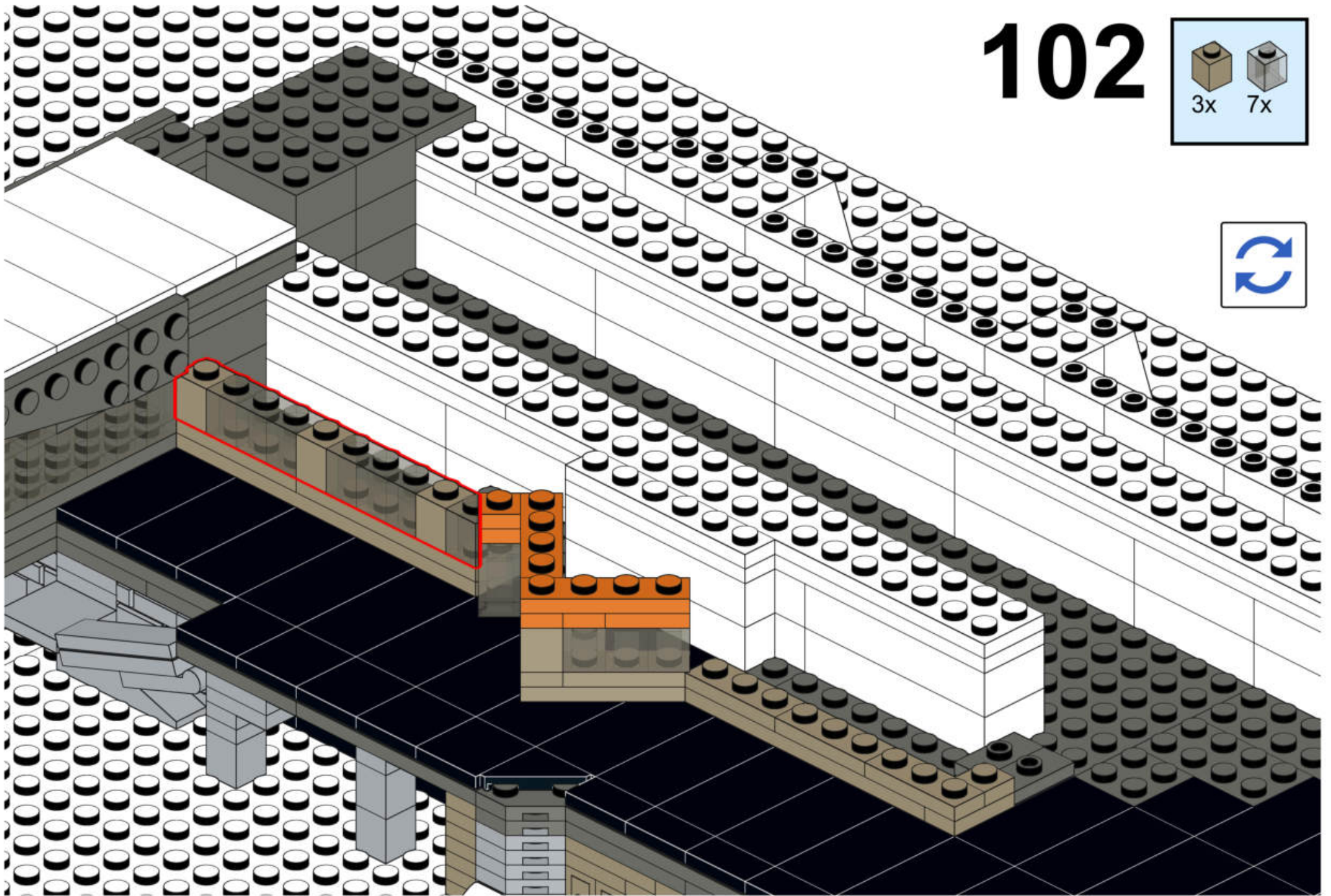
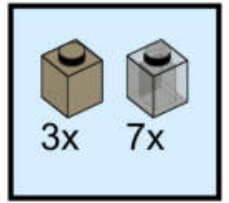



# 103

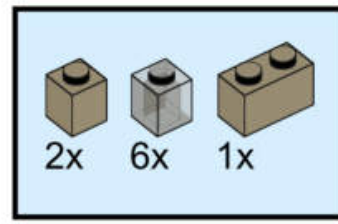

2x 6x 1x

This inset box shows the parts list for step 103. It contains three items: a tan 1x2x2 brick with 2 holes (labeled '2x'), a grey 1x2x2 brick with 2 holes (labeled '6x'), and a tan 1x2x2 brick with 2 holes (labeled '1x').

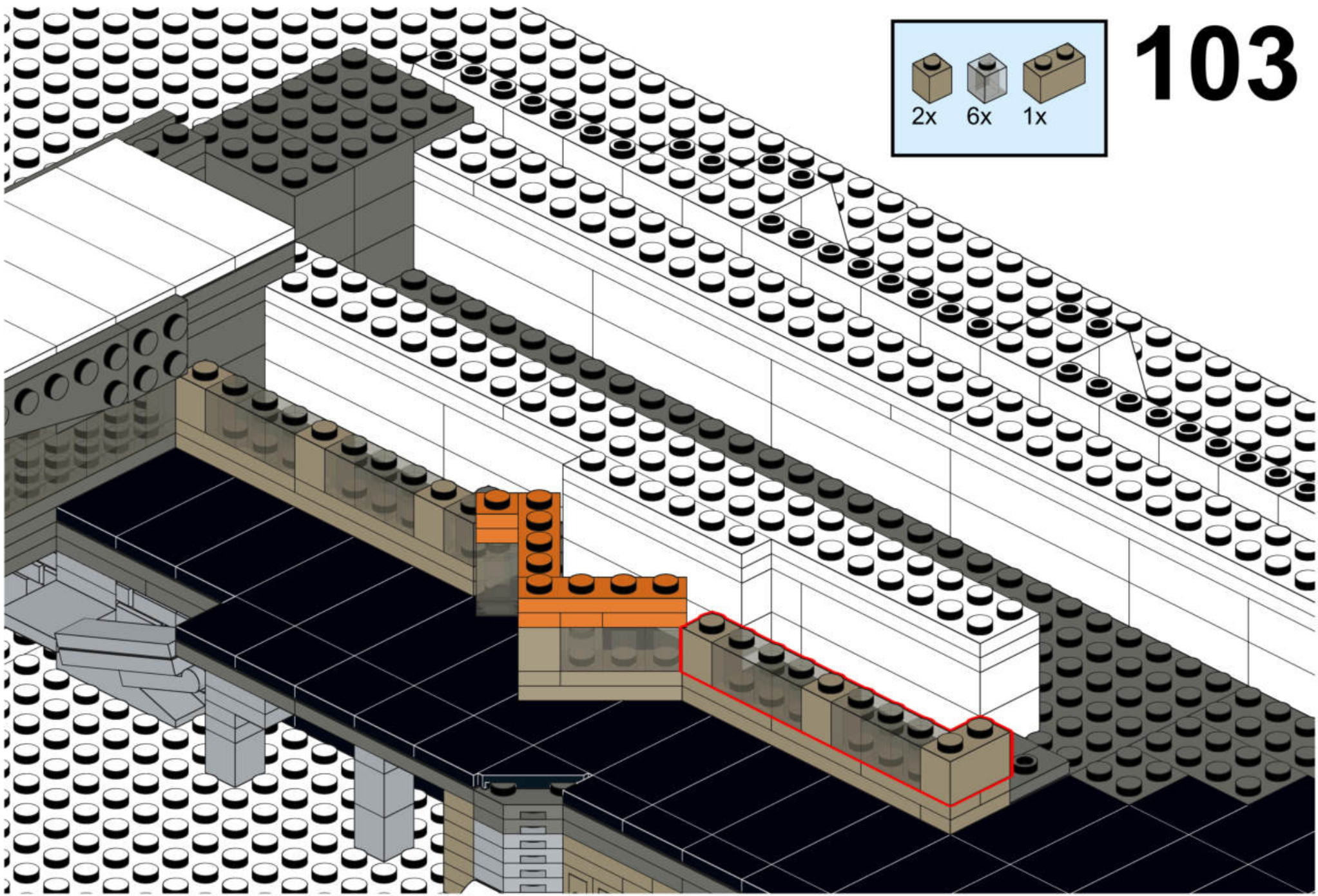



# 104

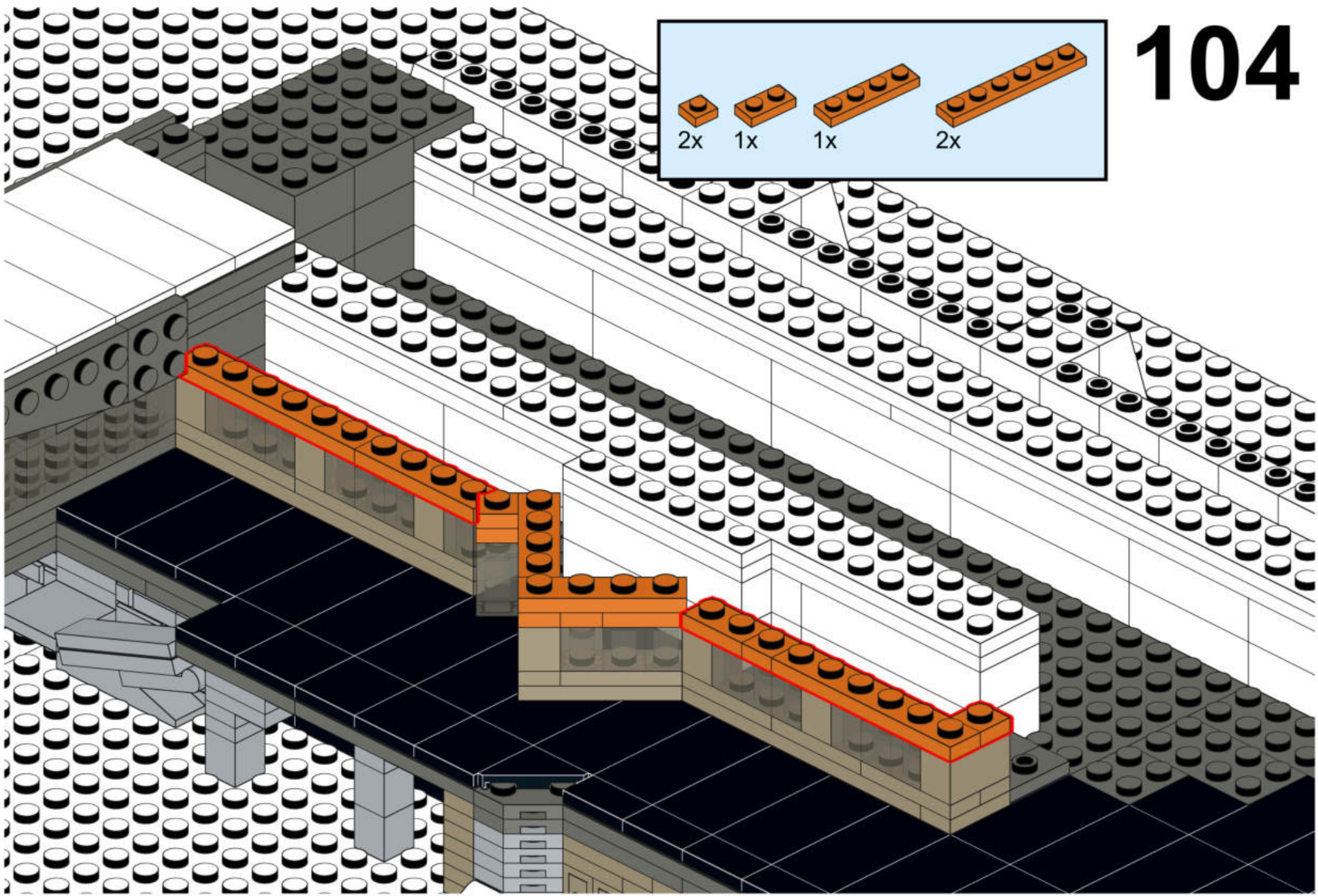
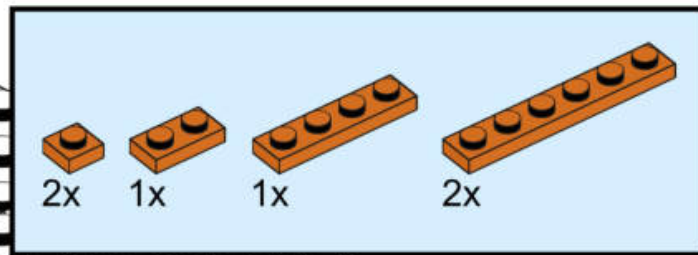



# 105

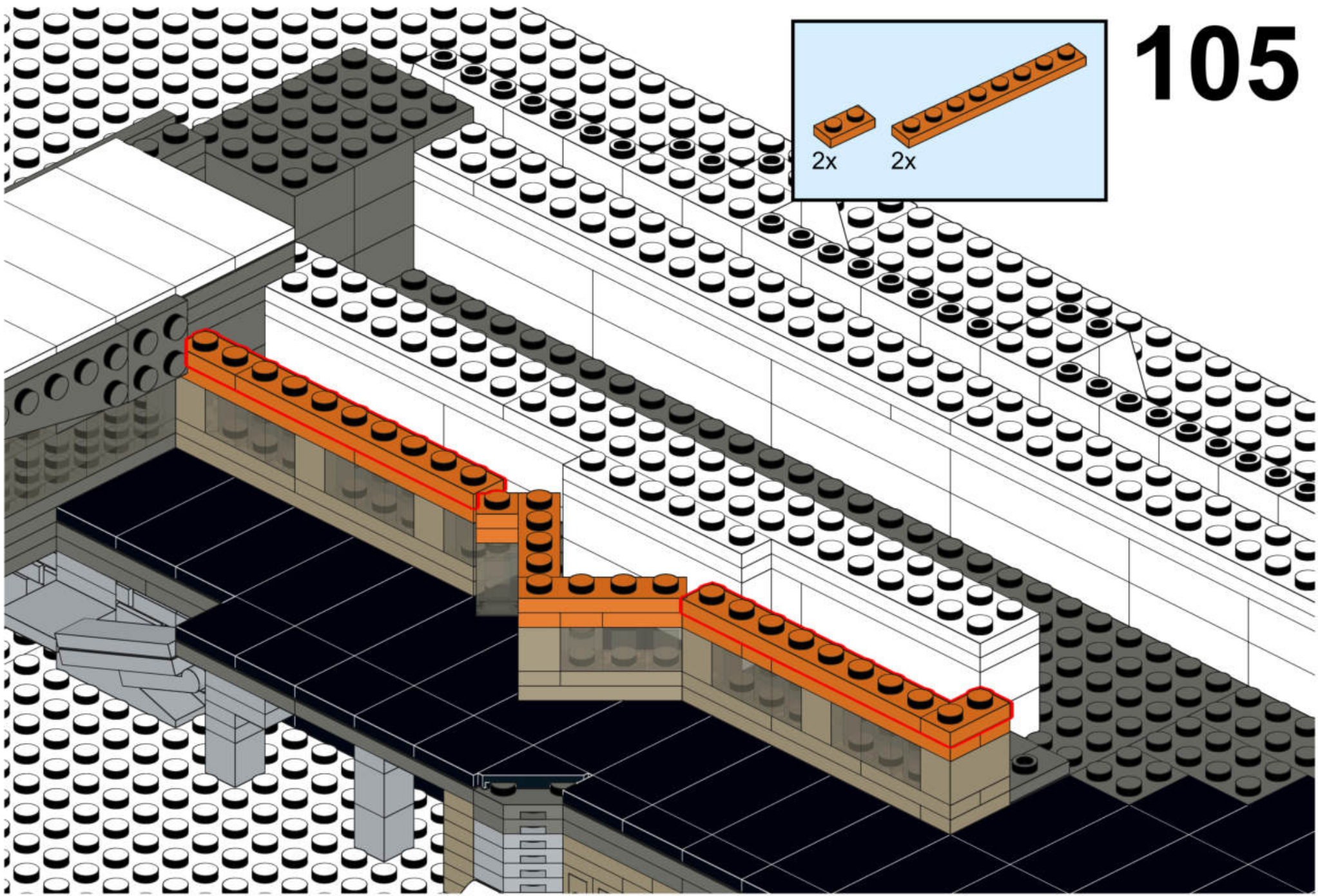
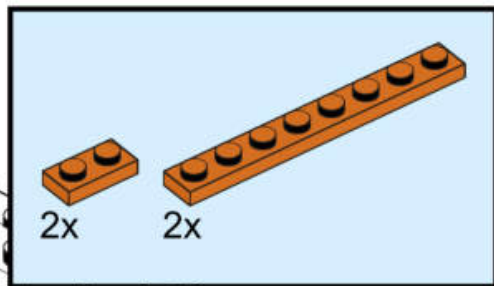



# 106

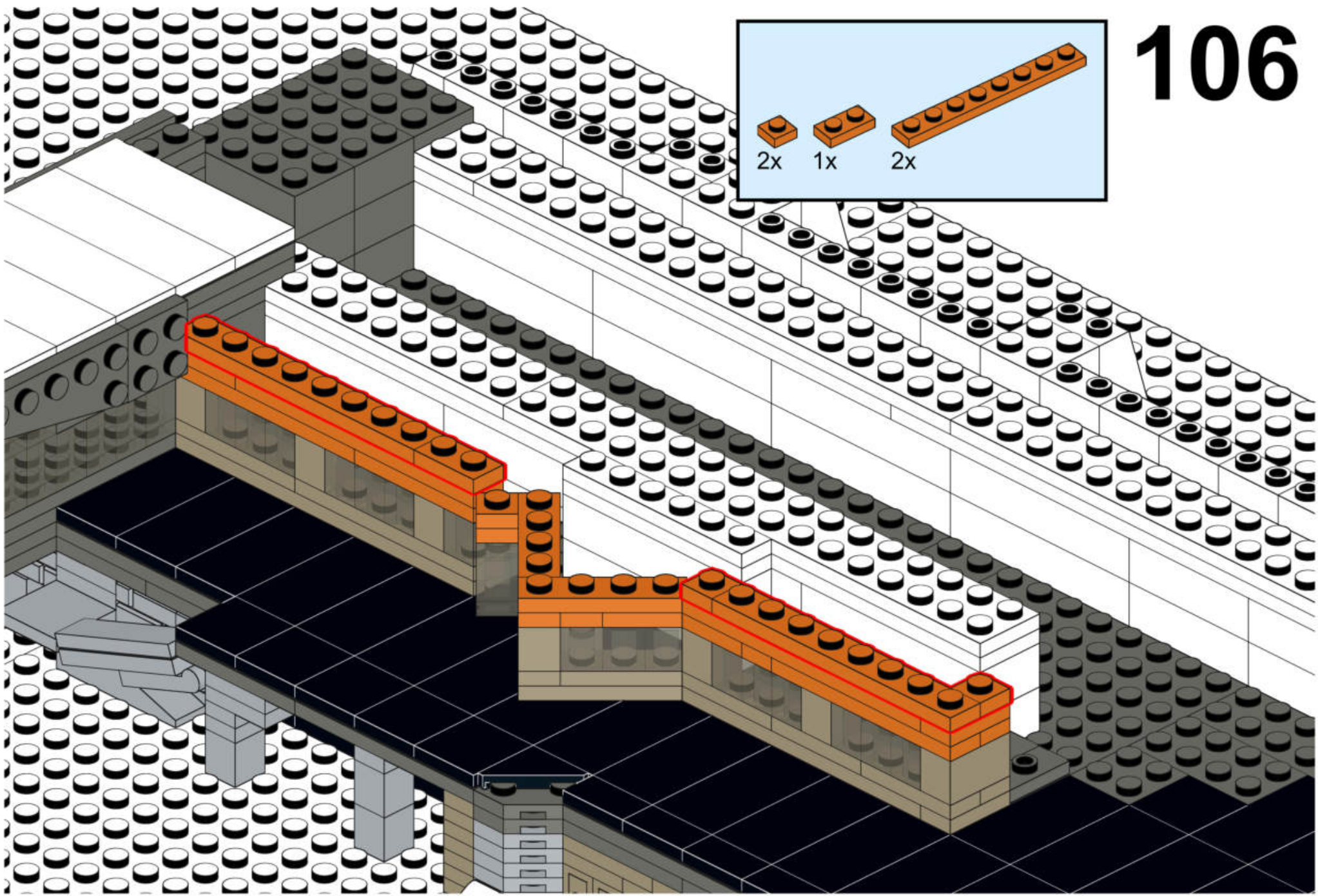
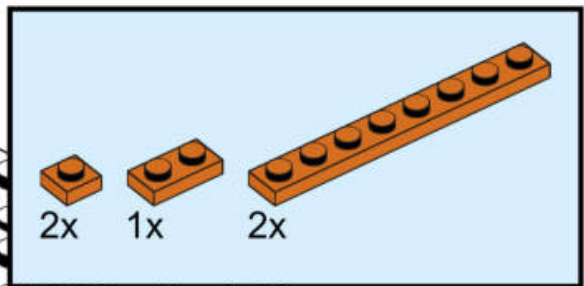



# 107

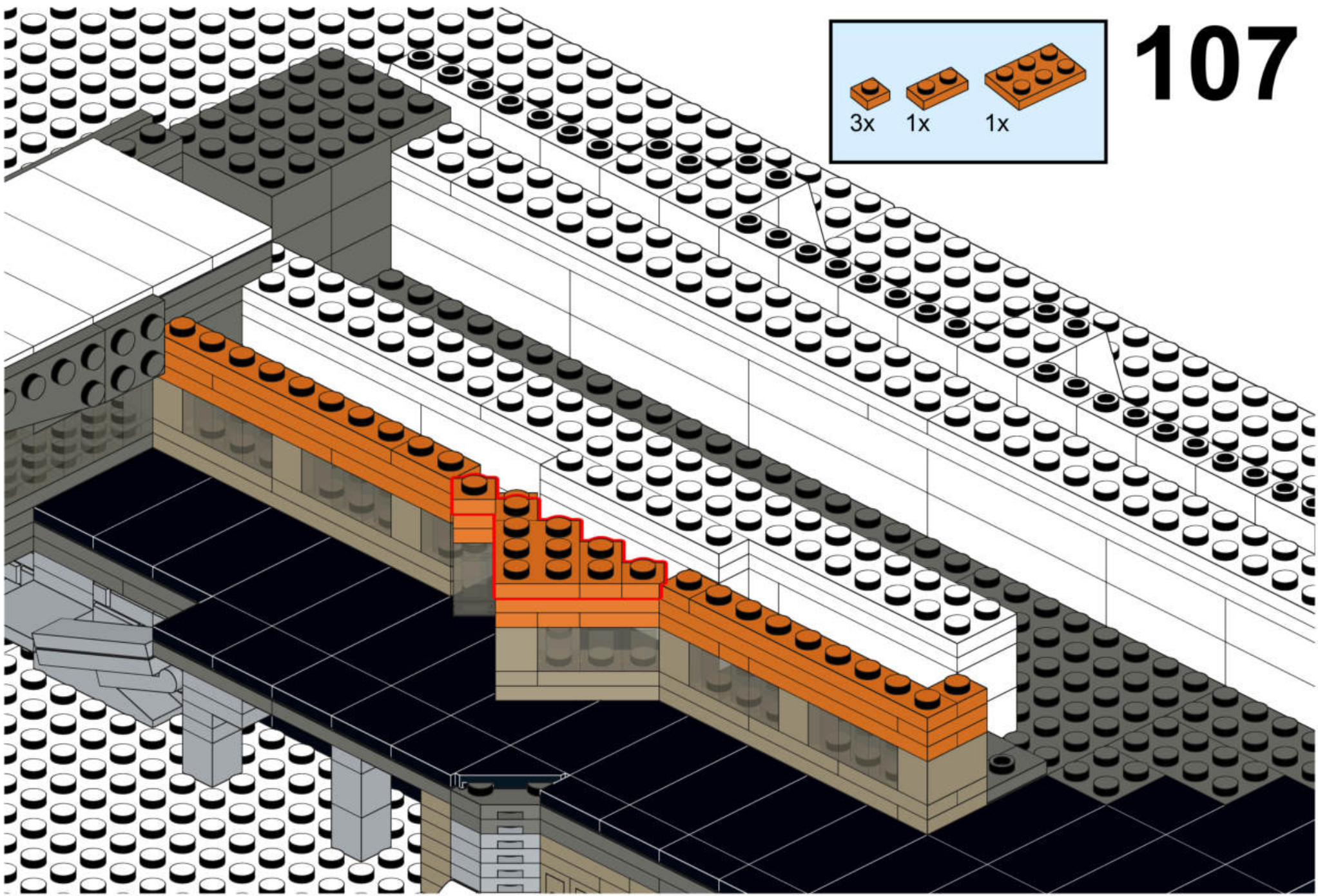
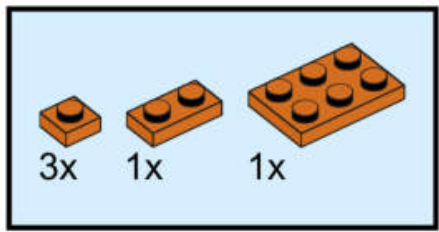



# 108

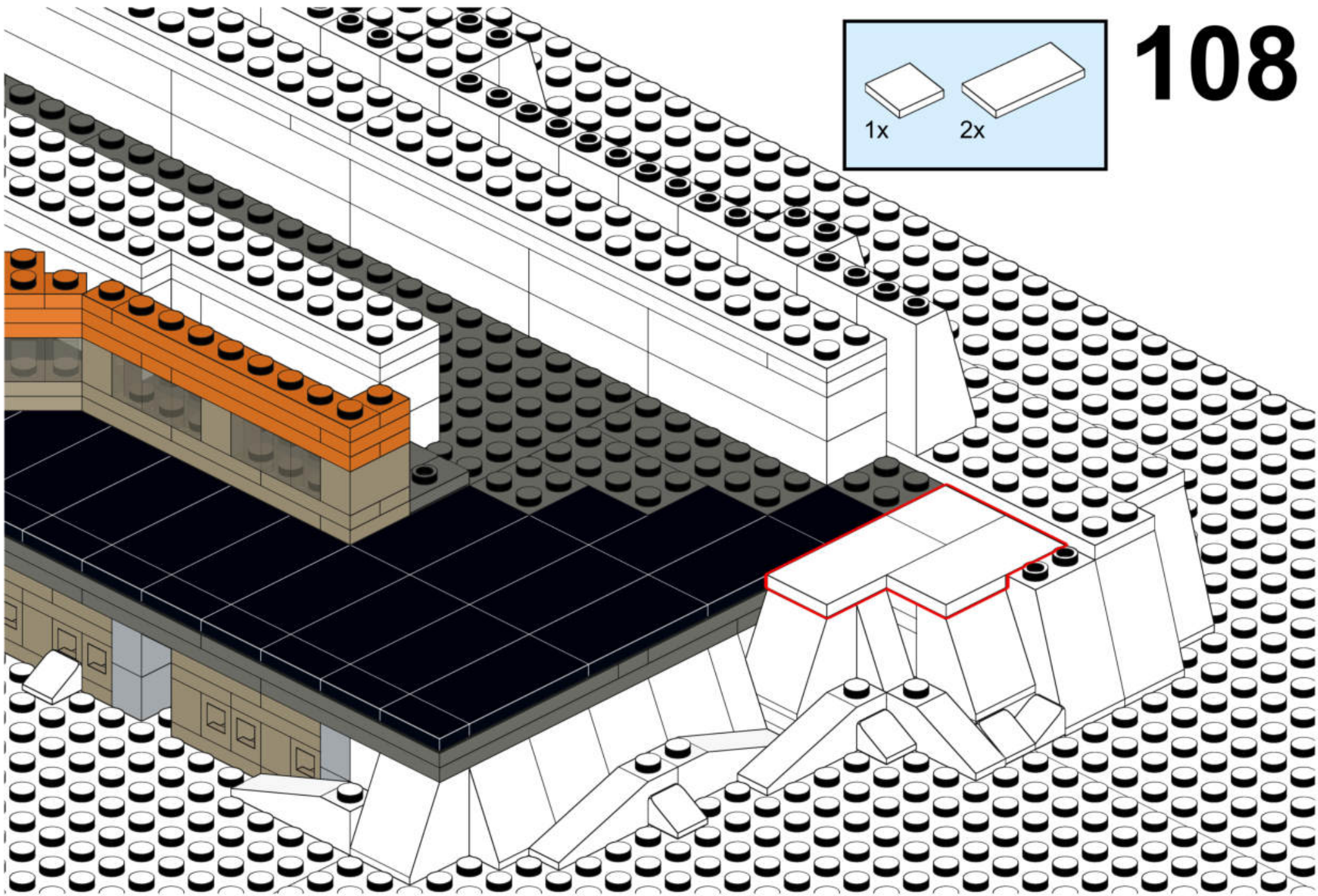
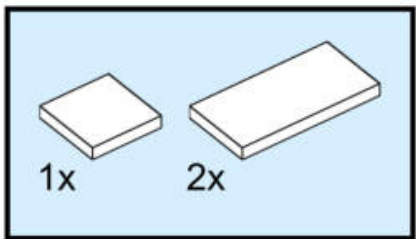



# 109

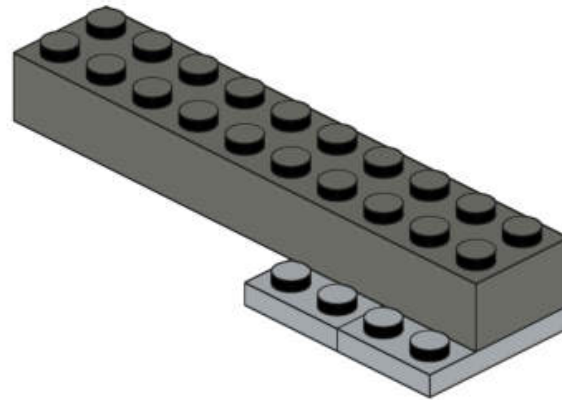
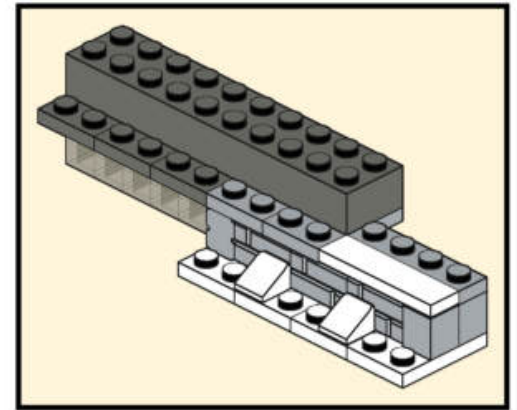
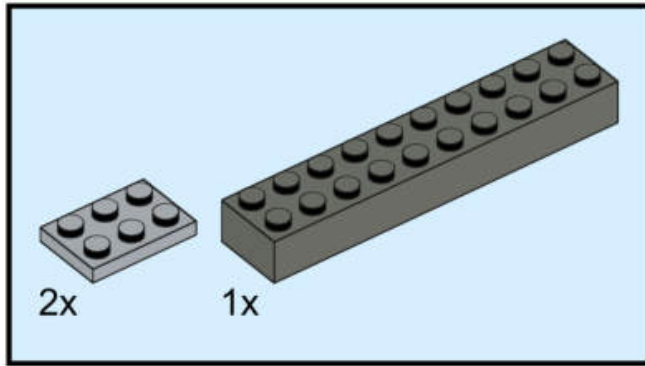



# 110

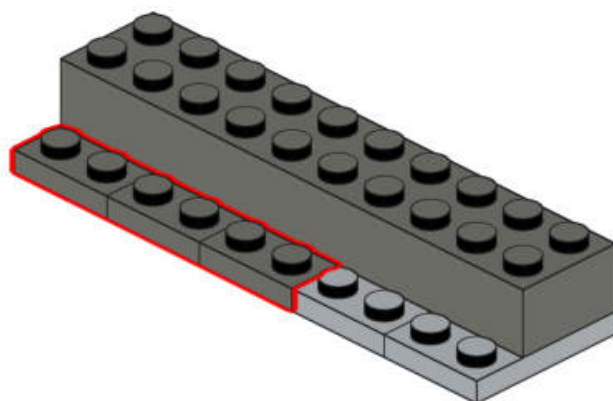
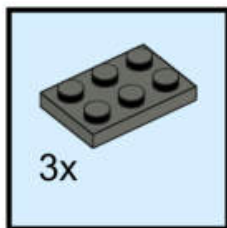



# 111

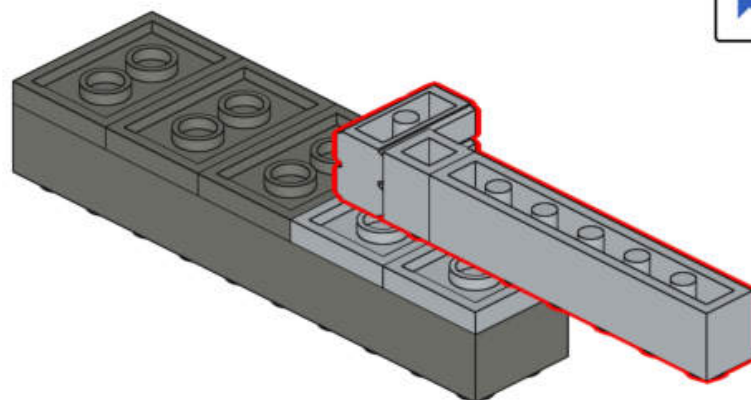
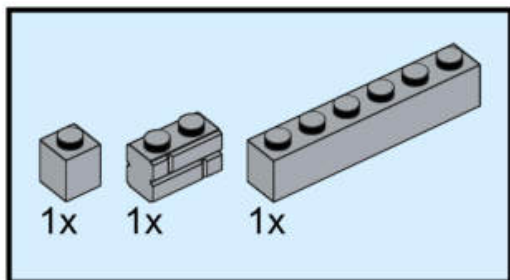



# 112

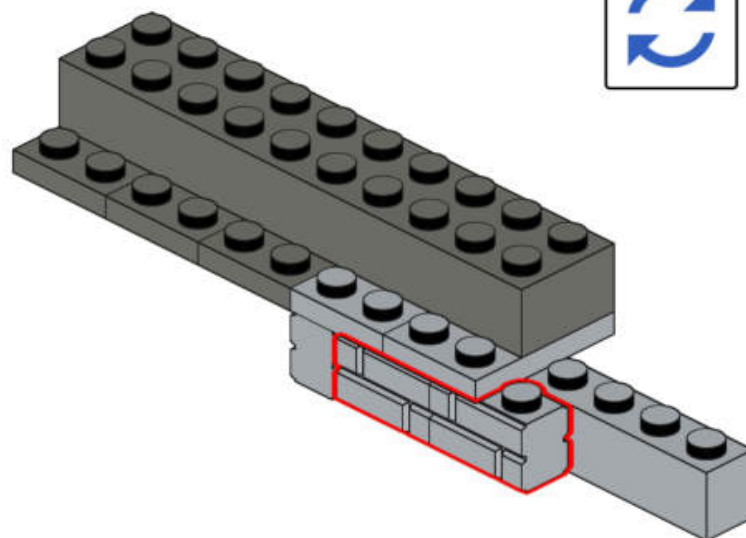
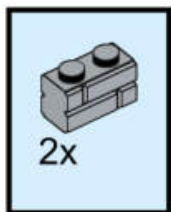



# 113

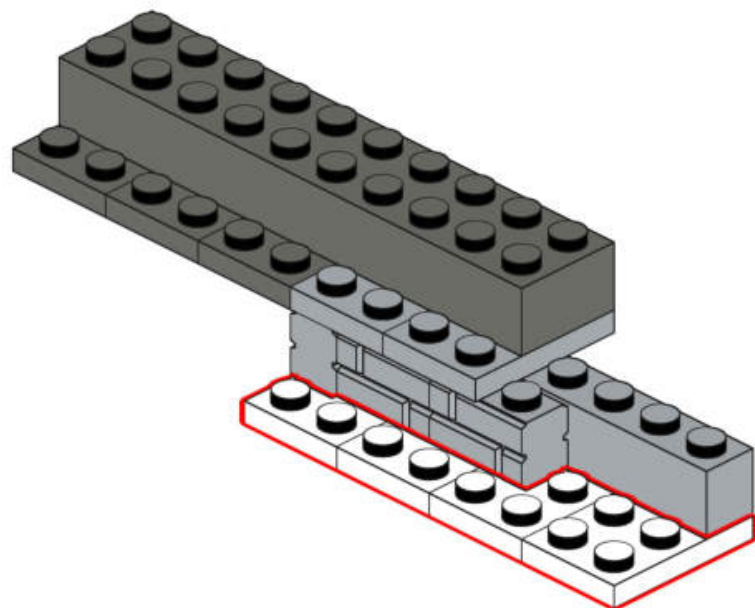
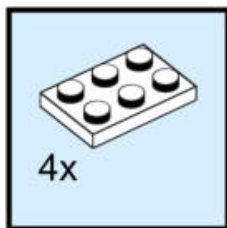



# 114

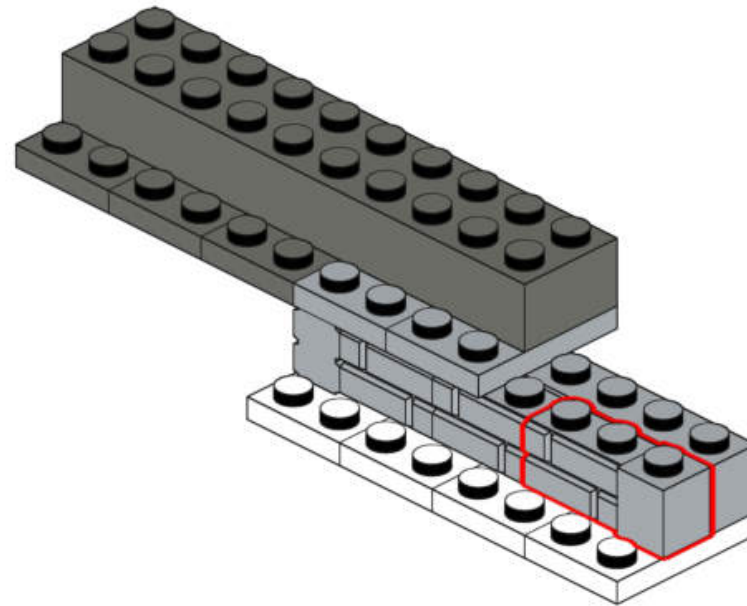
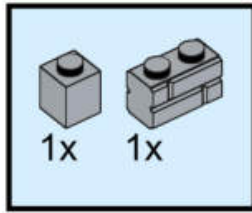



# 115

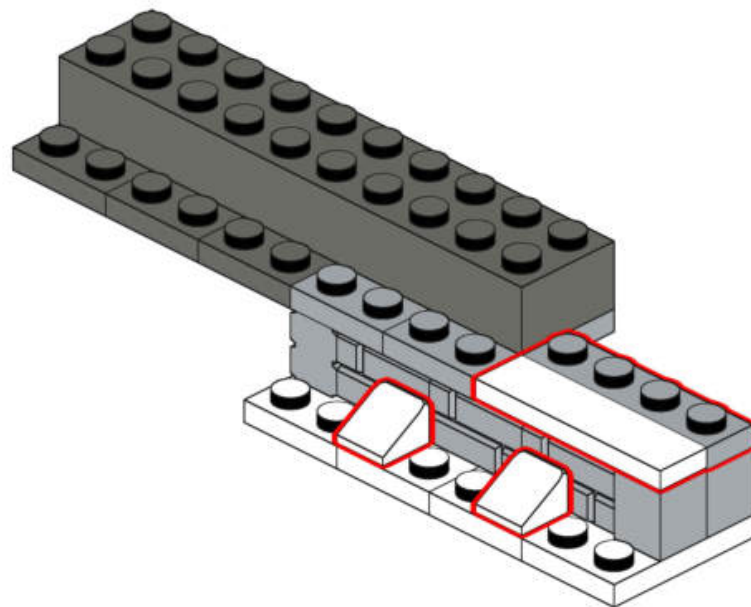
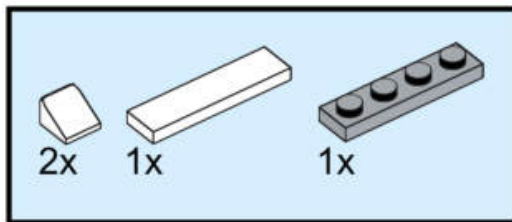



# 116

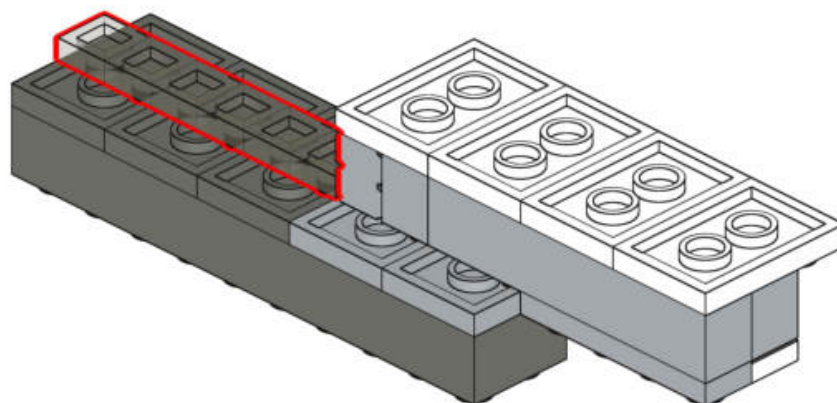
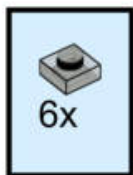



# 117

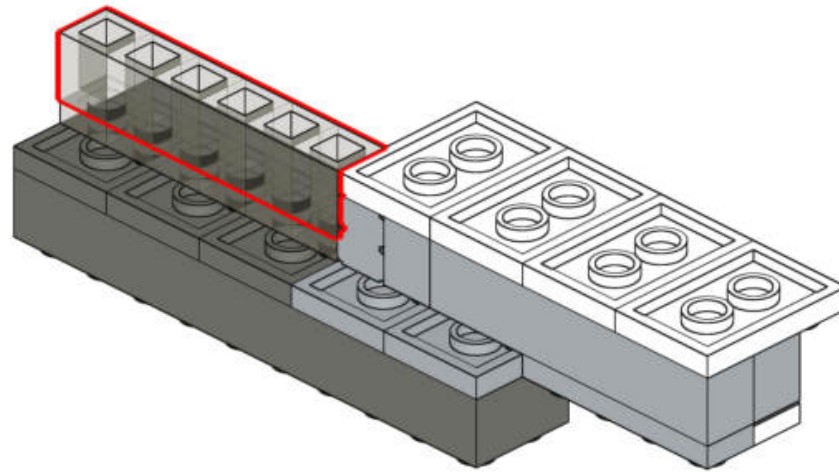
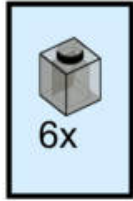



# 118

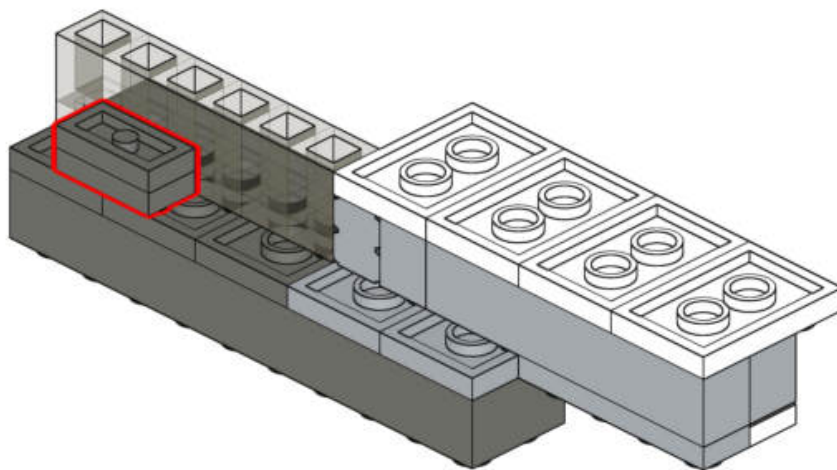
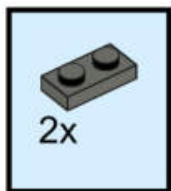



# 119

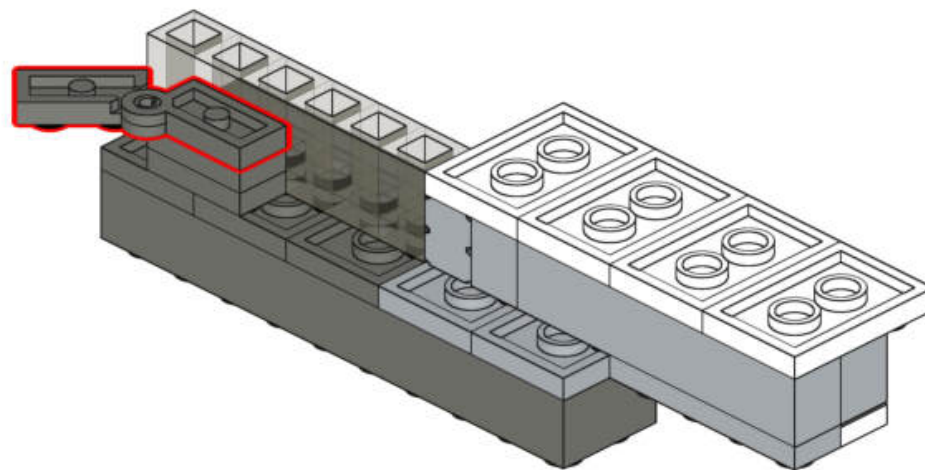
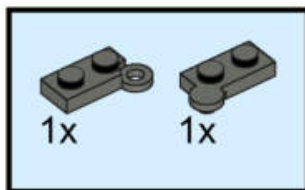



# 120

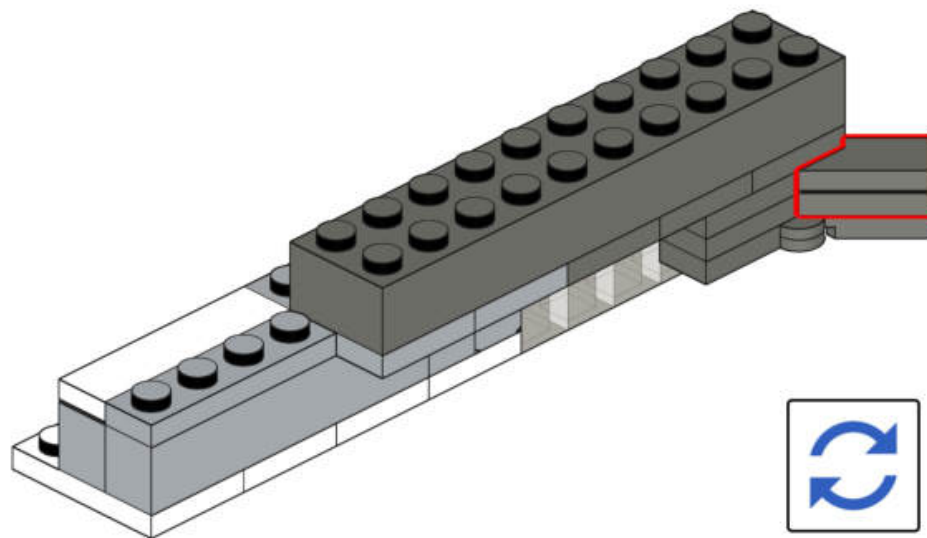
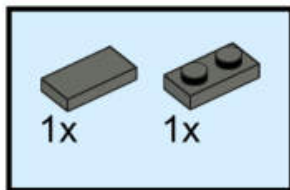

# 121

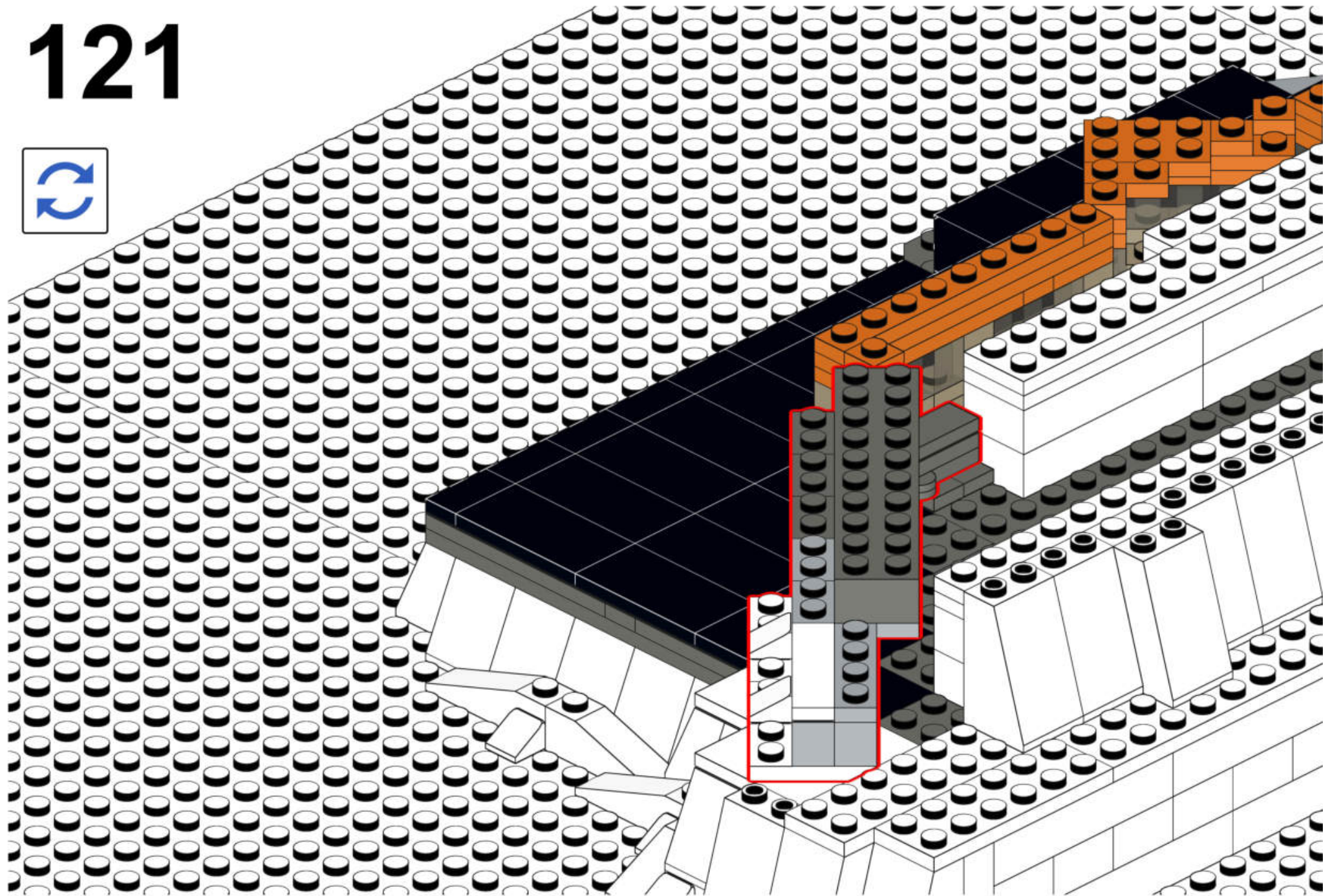



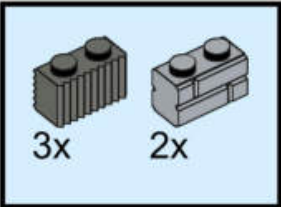

# 122

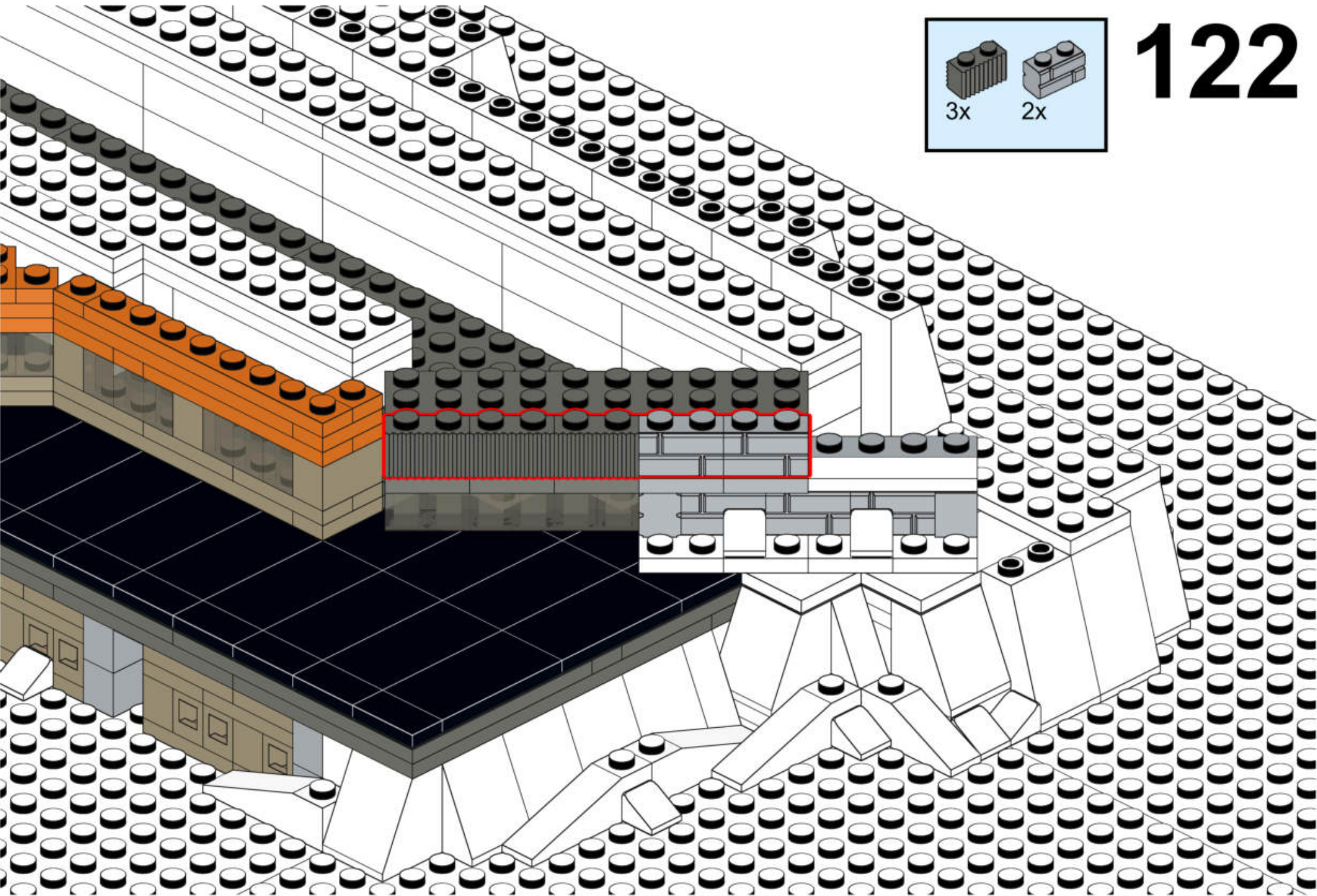



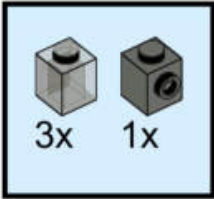

# 123

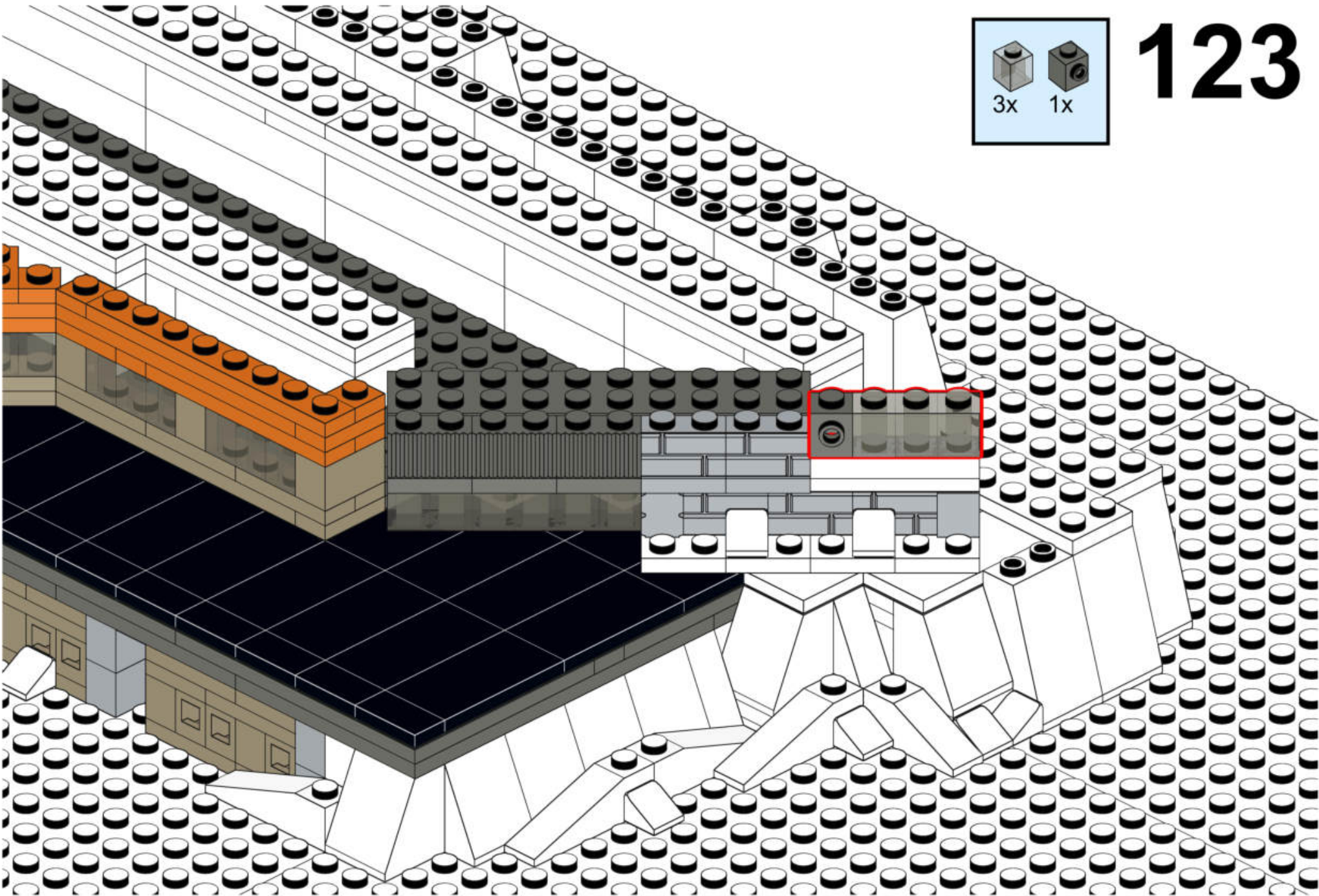



# 124

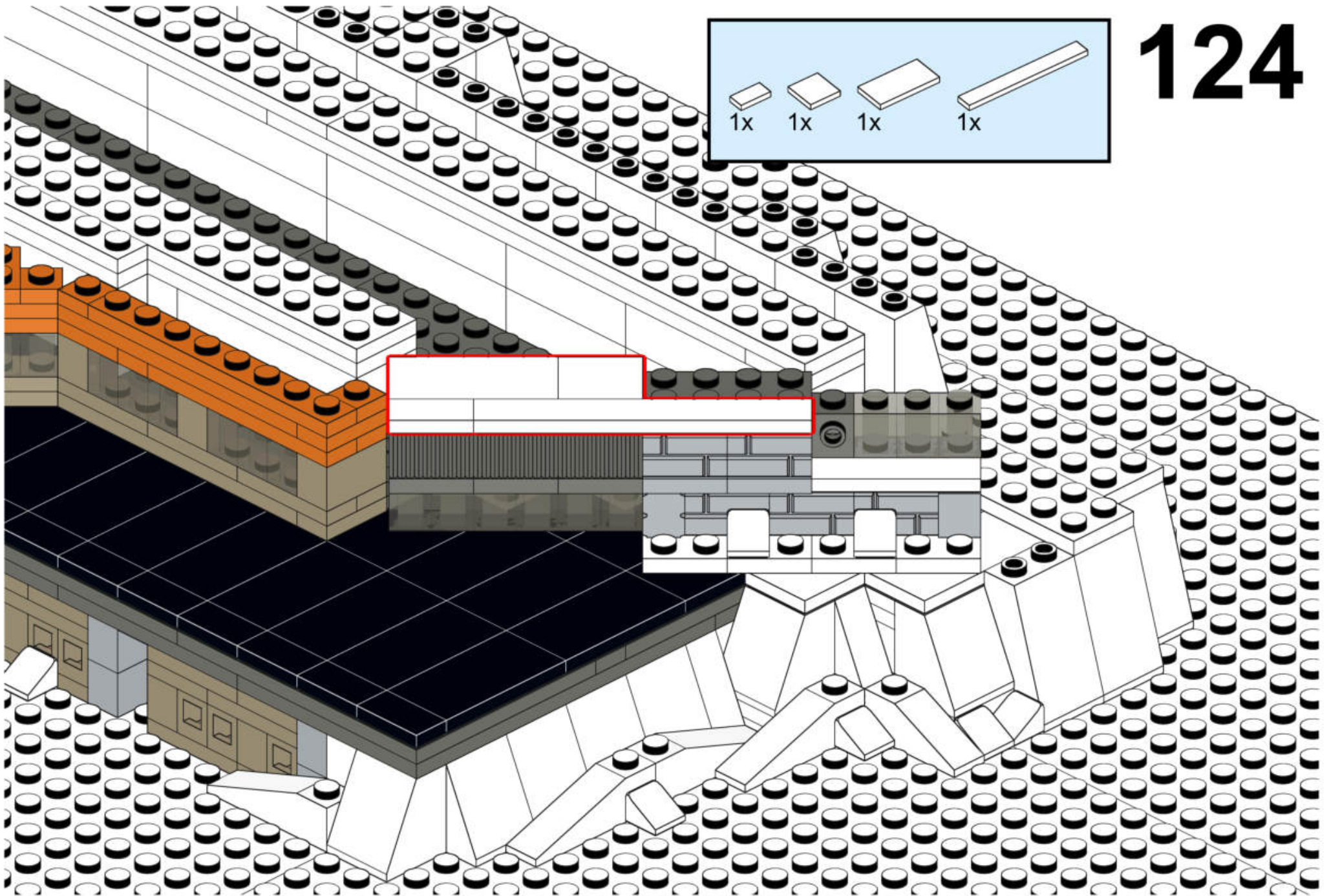
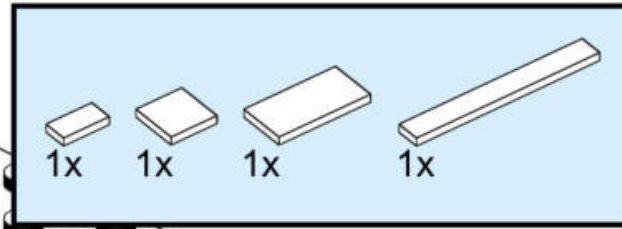



# 125

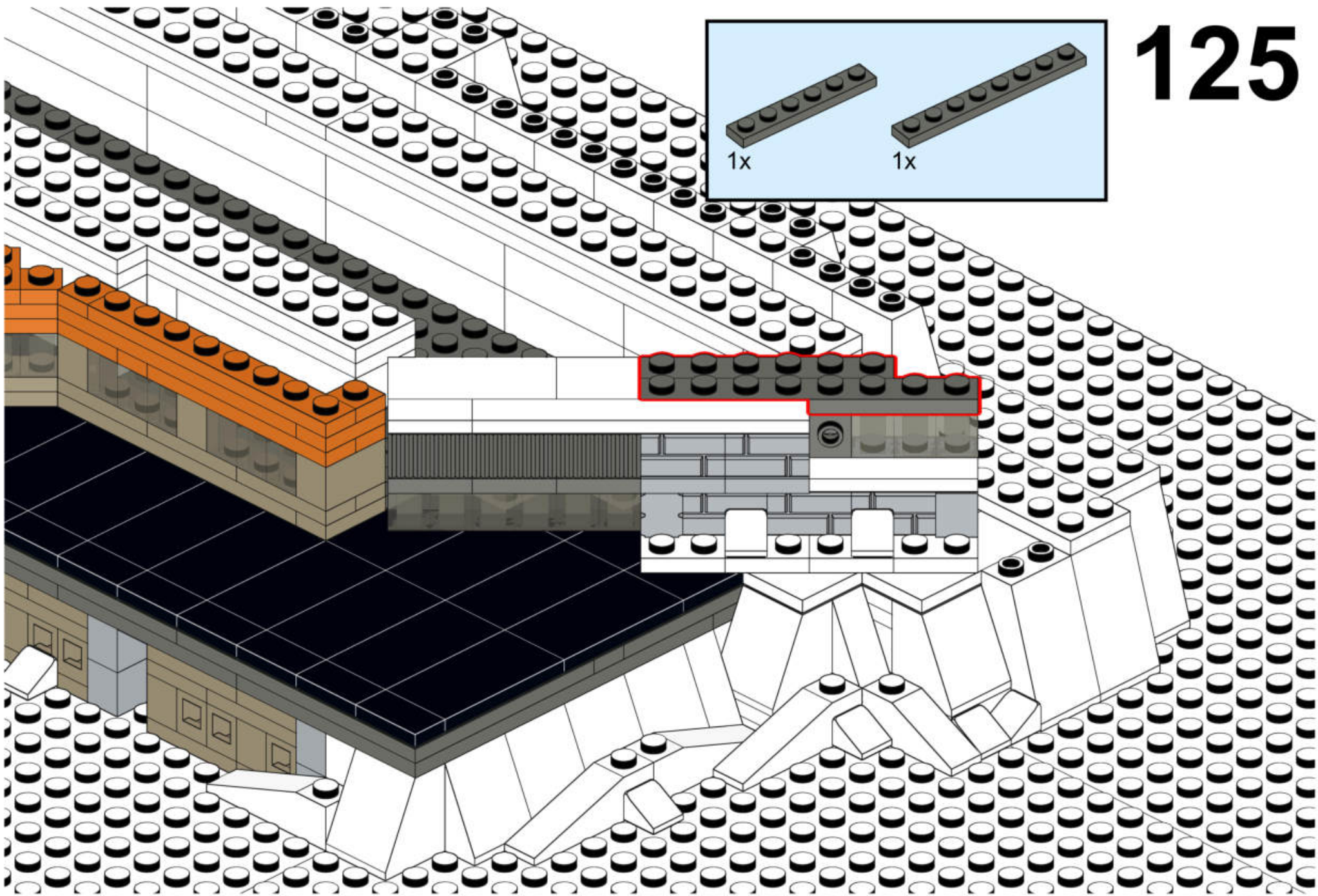
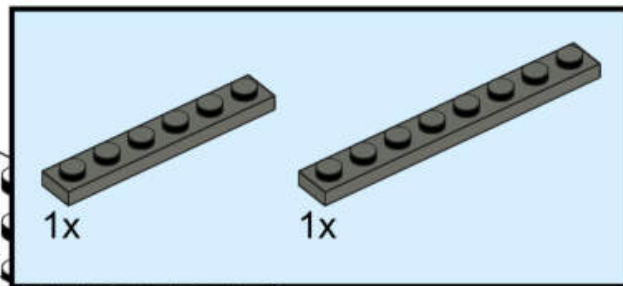



# 126

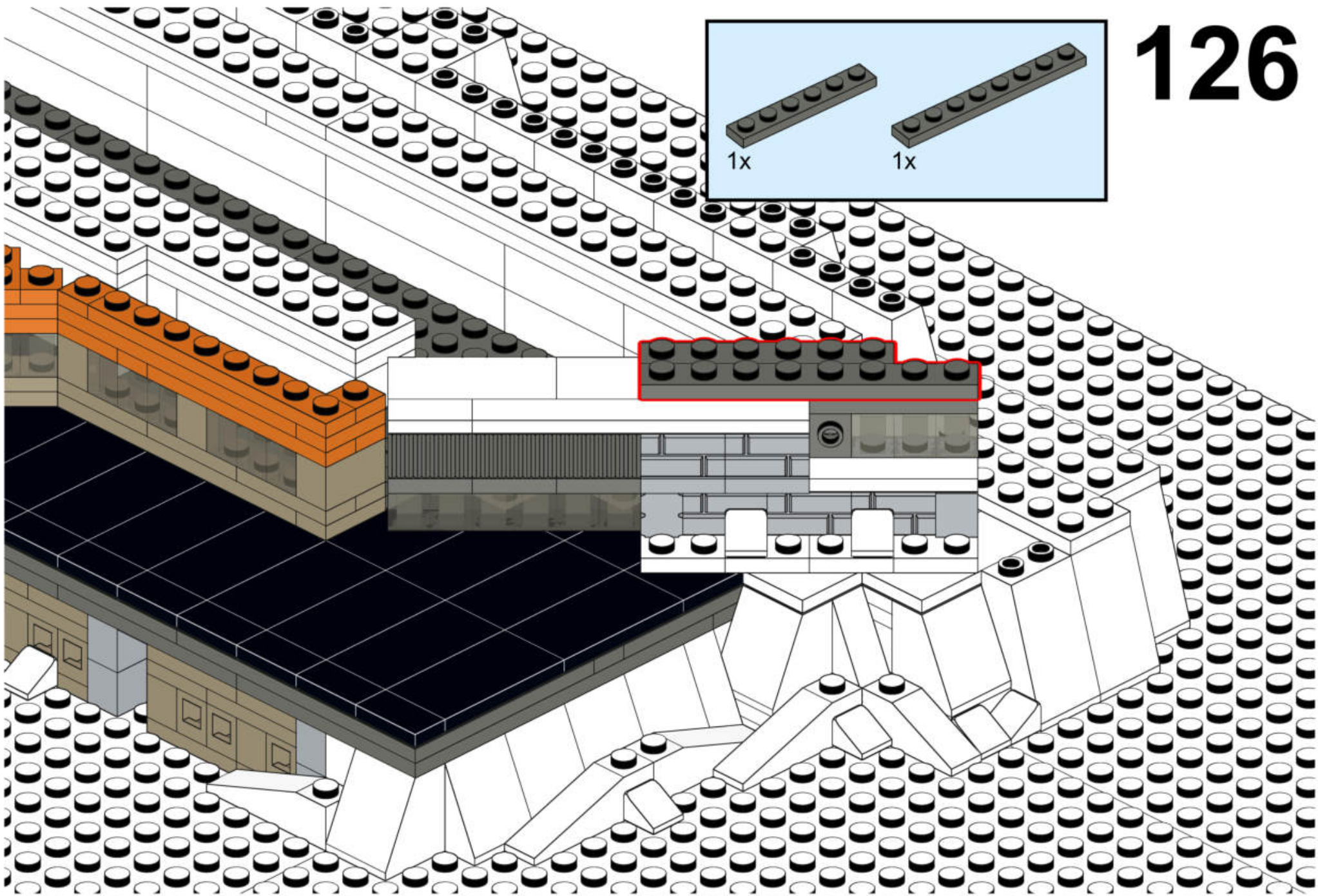
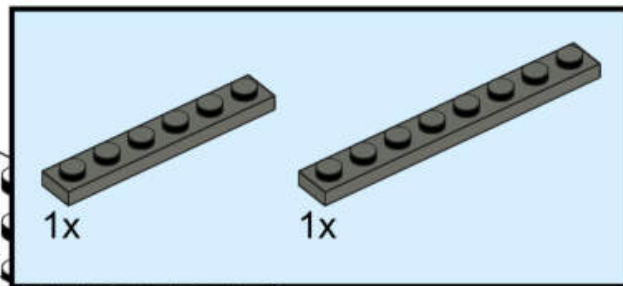



# 127

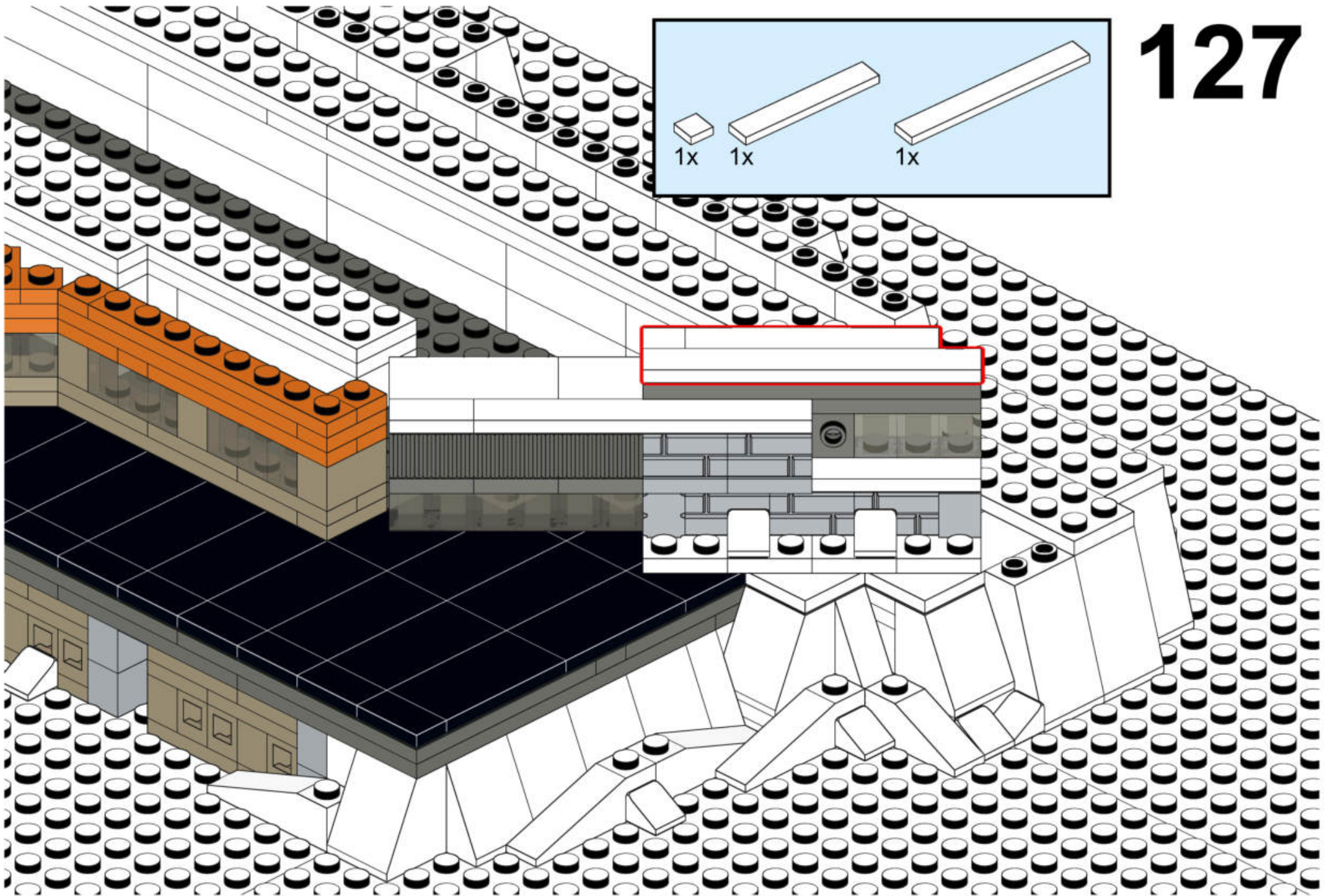
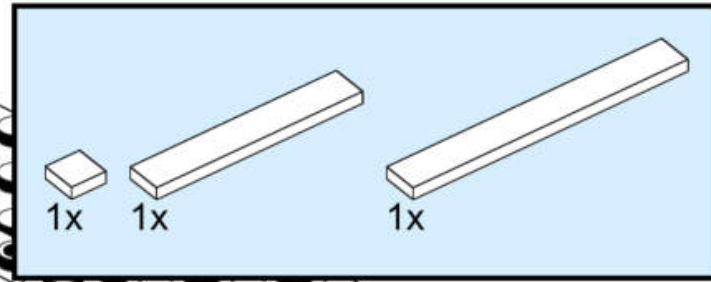



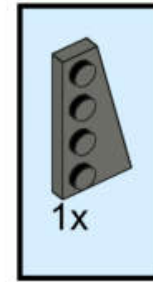

128

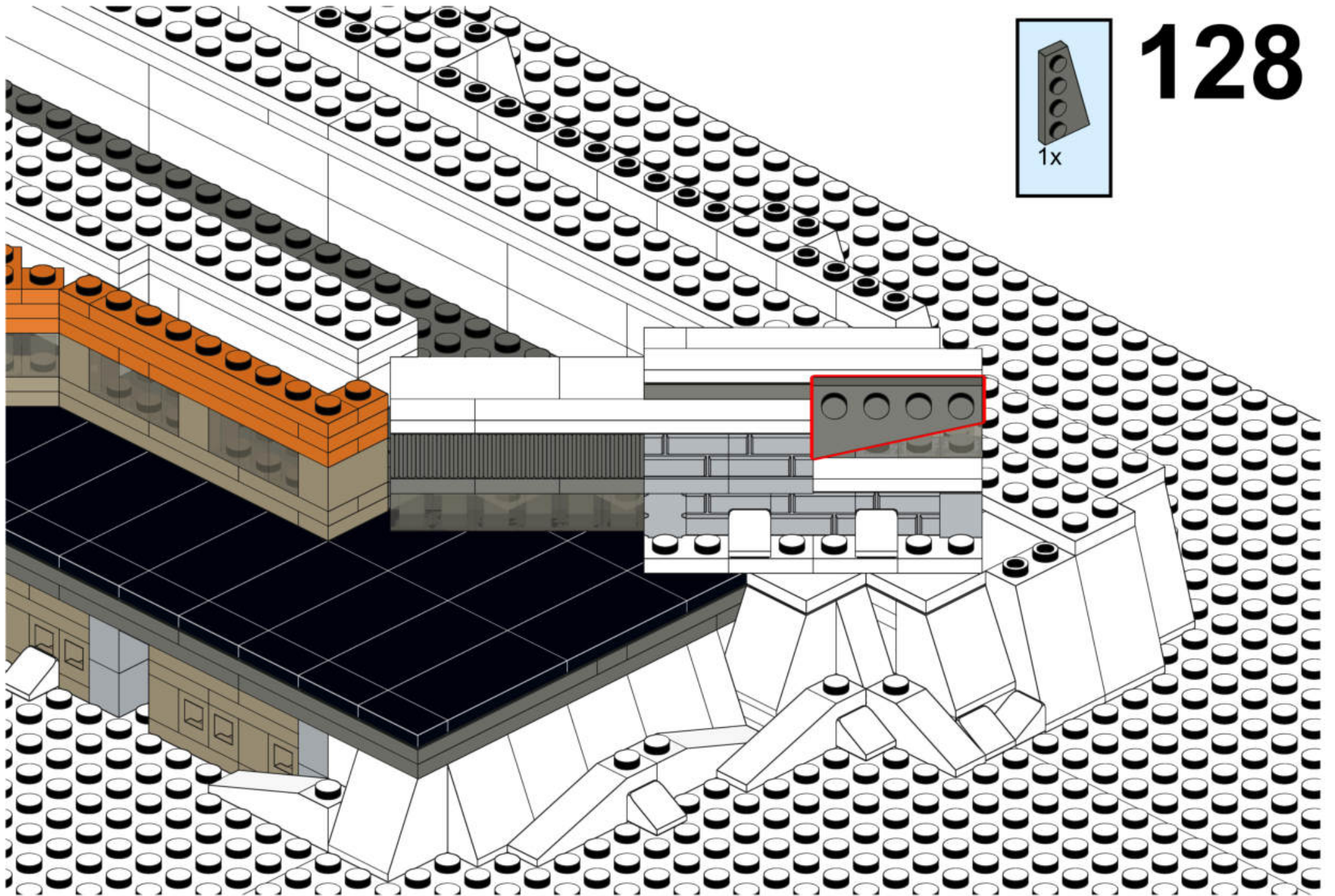



# 129

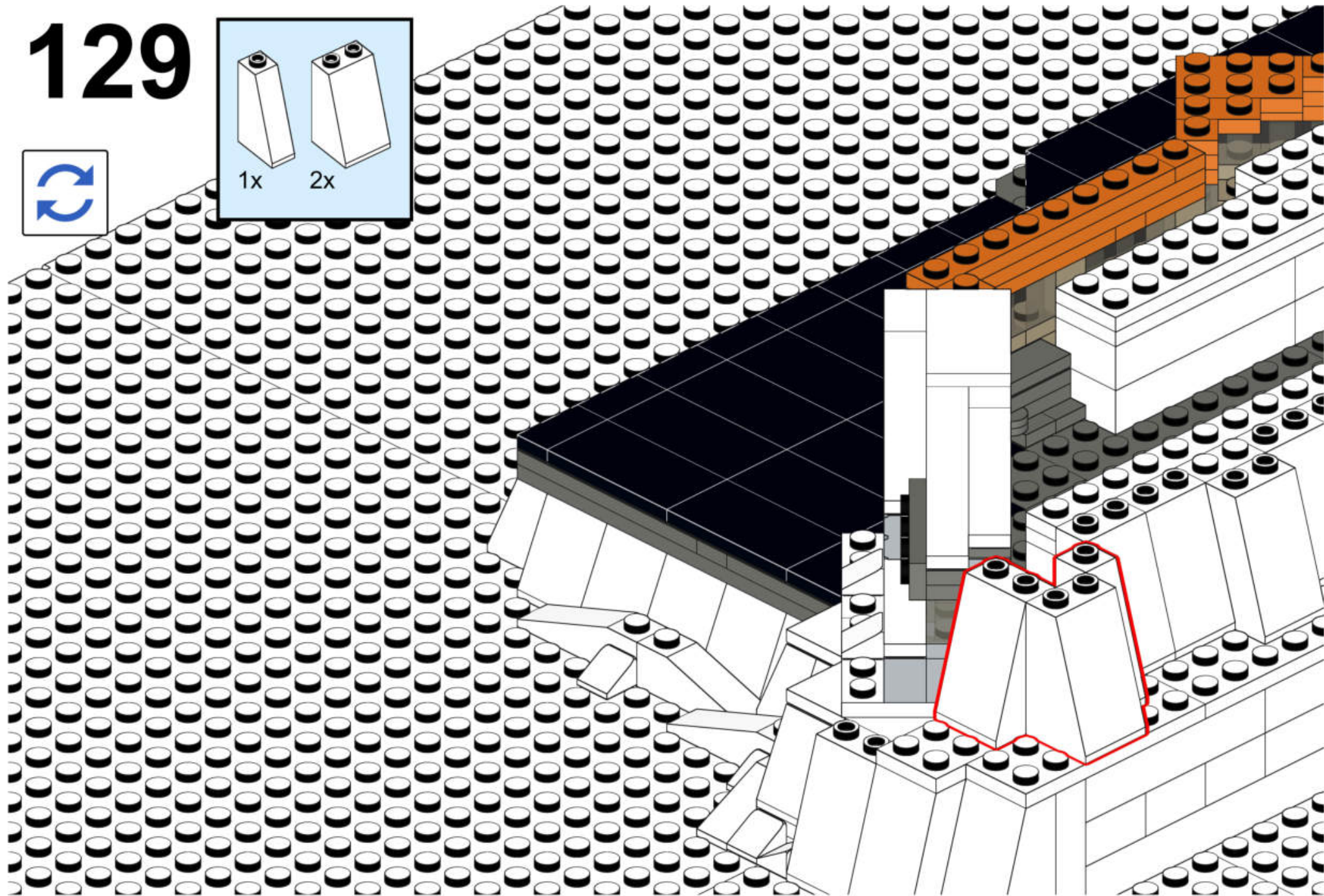
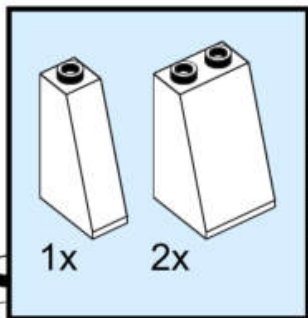



# 130

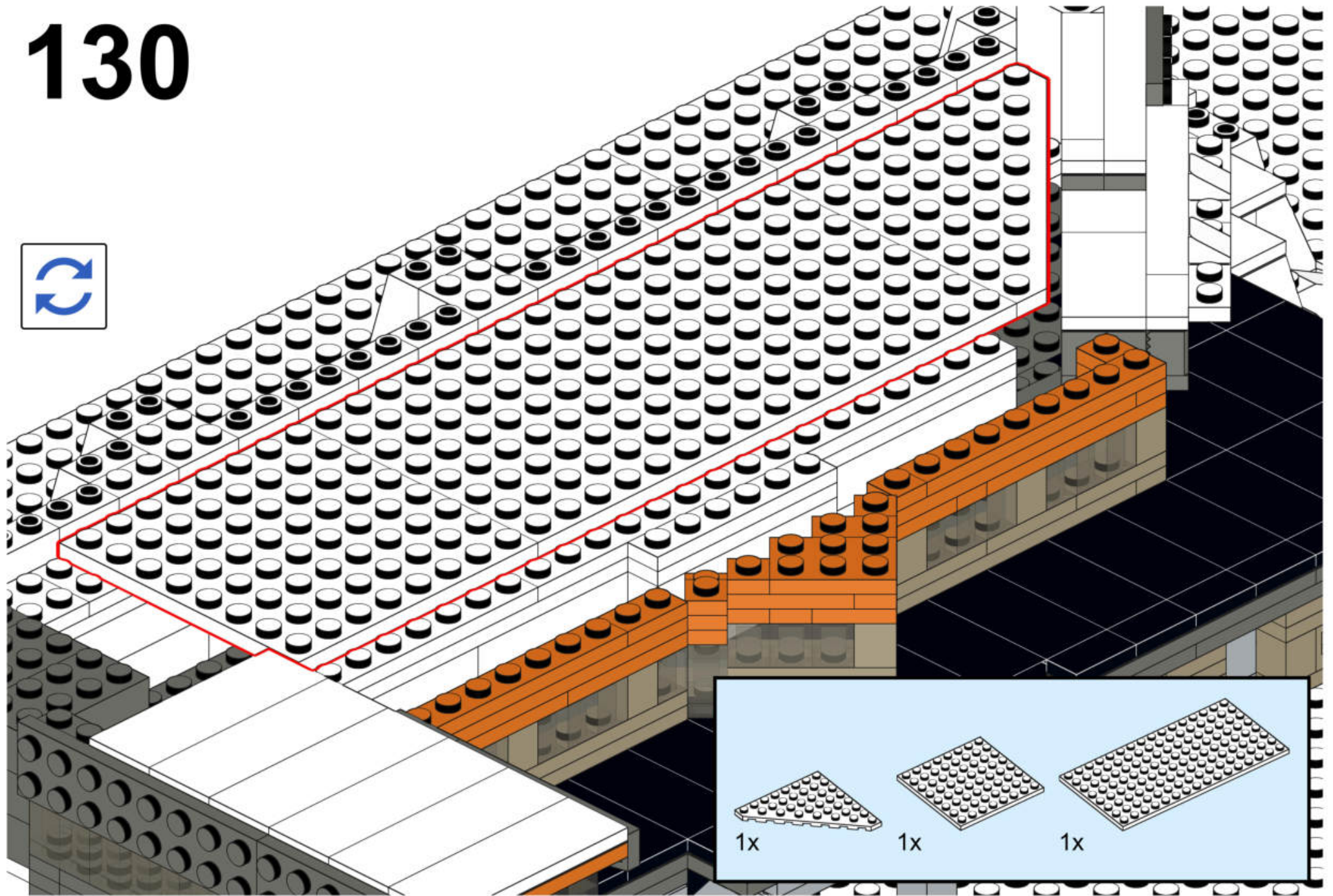

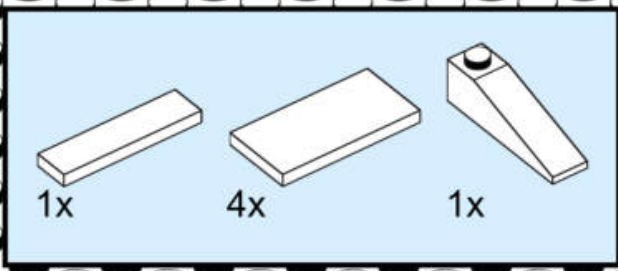

# 131

A light blue rectangular box containing three white LEGO parts. The first is a 1x3 Technic beam with the text '1x' below it. The second is a 1x4 Technic beam with the text '4x' below it. The third is a 1x4 Technic beam with a 1x1 Technic brick on top, with the text '1x' below it.

1x      4x      1x

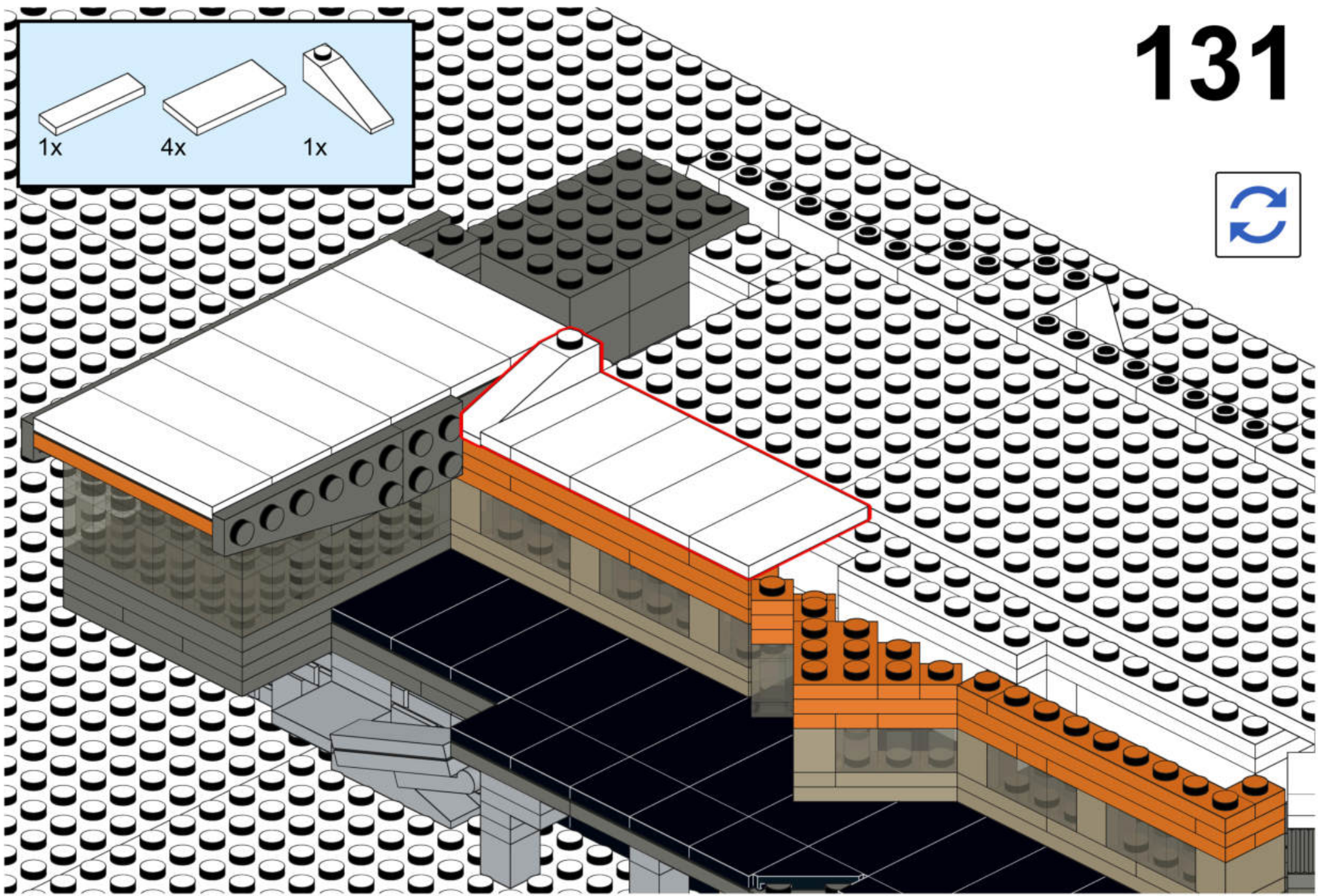



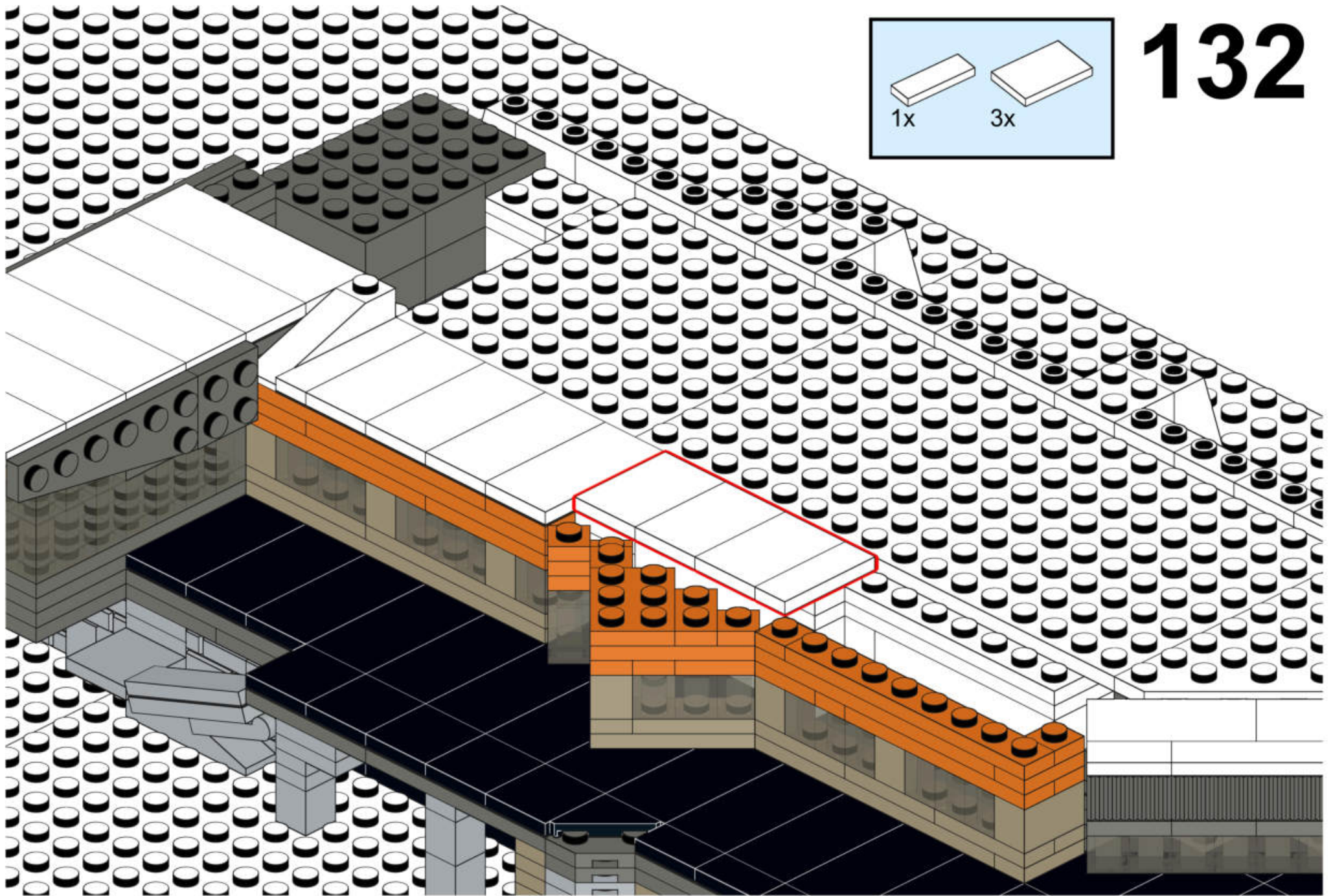



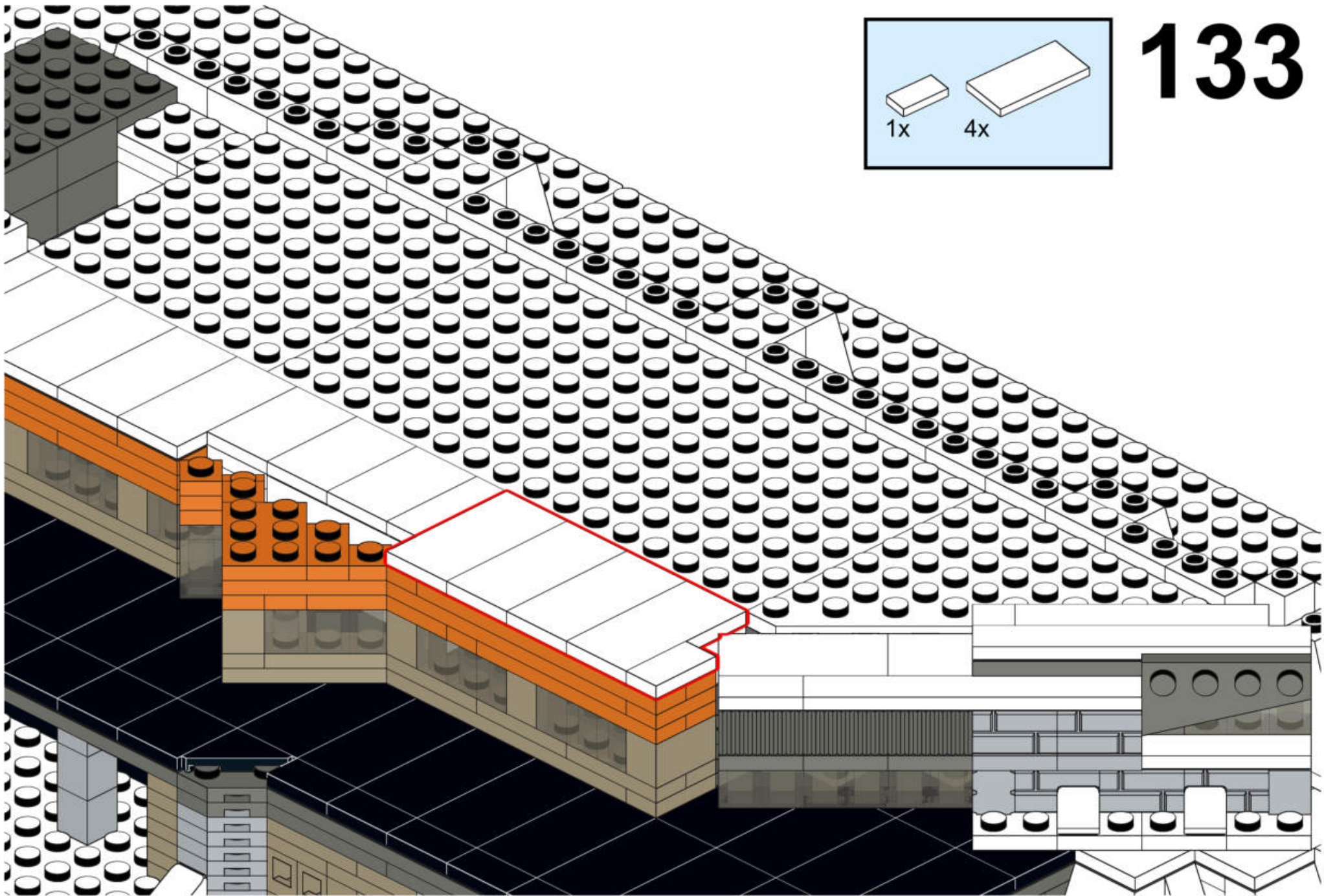



# 134

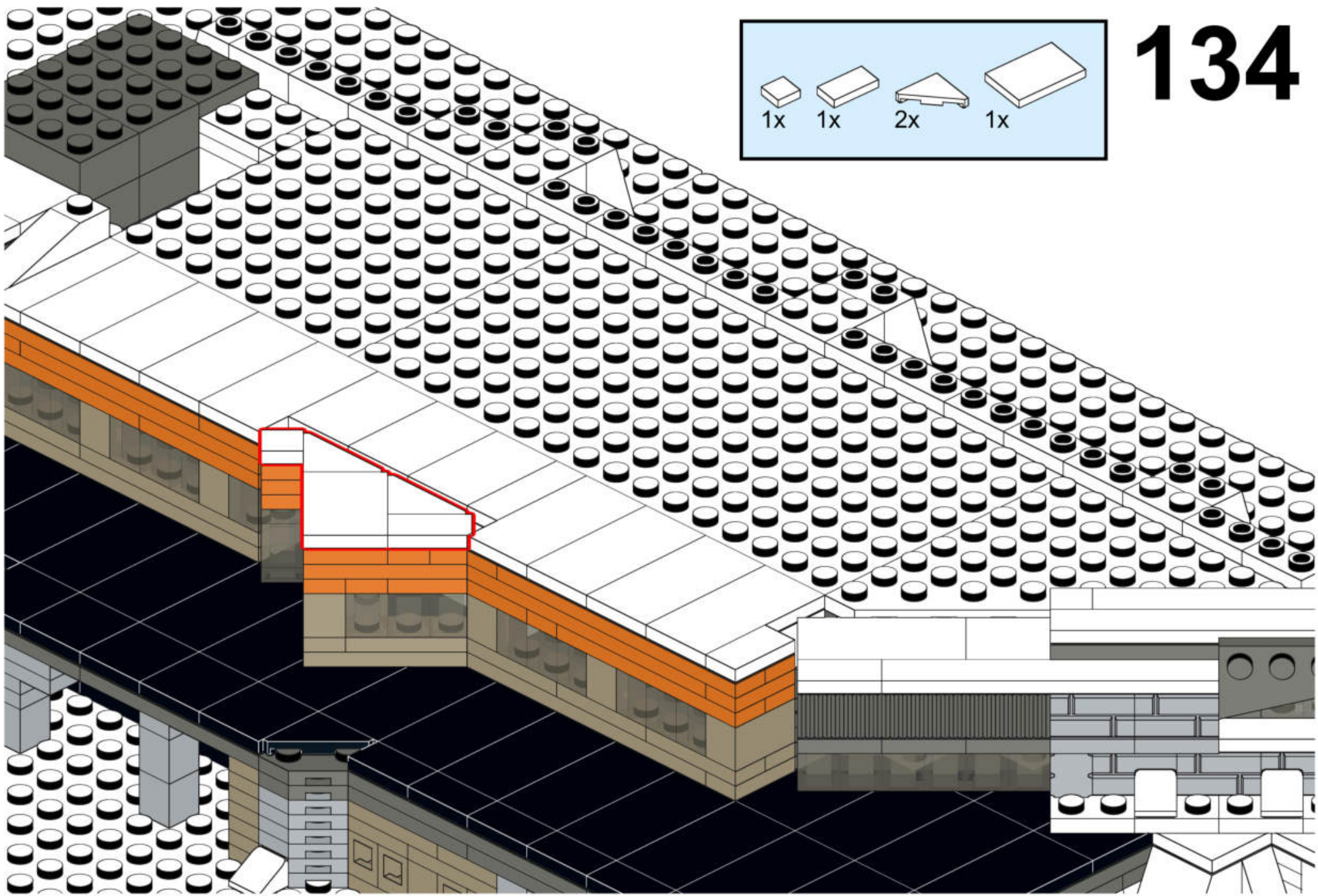
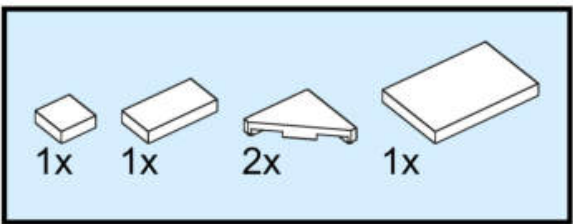



# 135

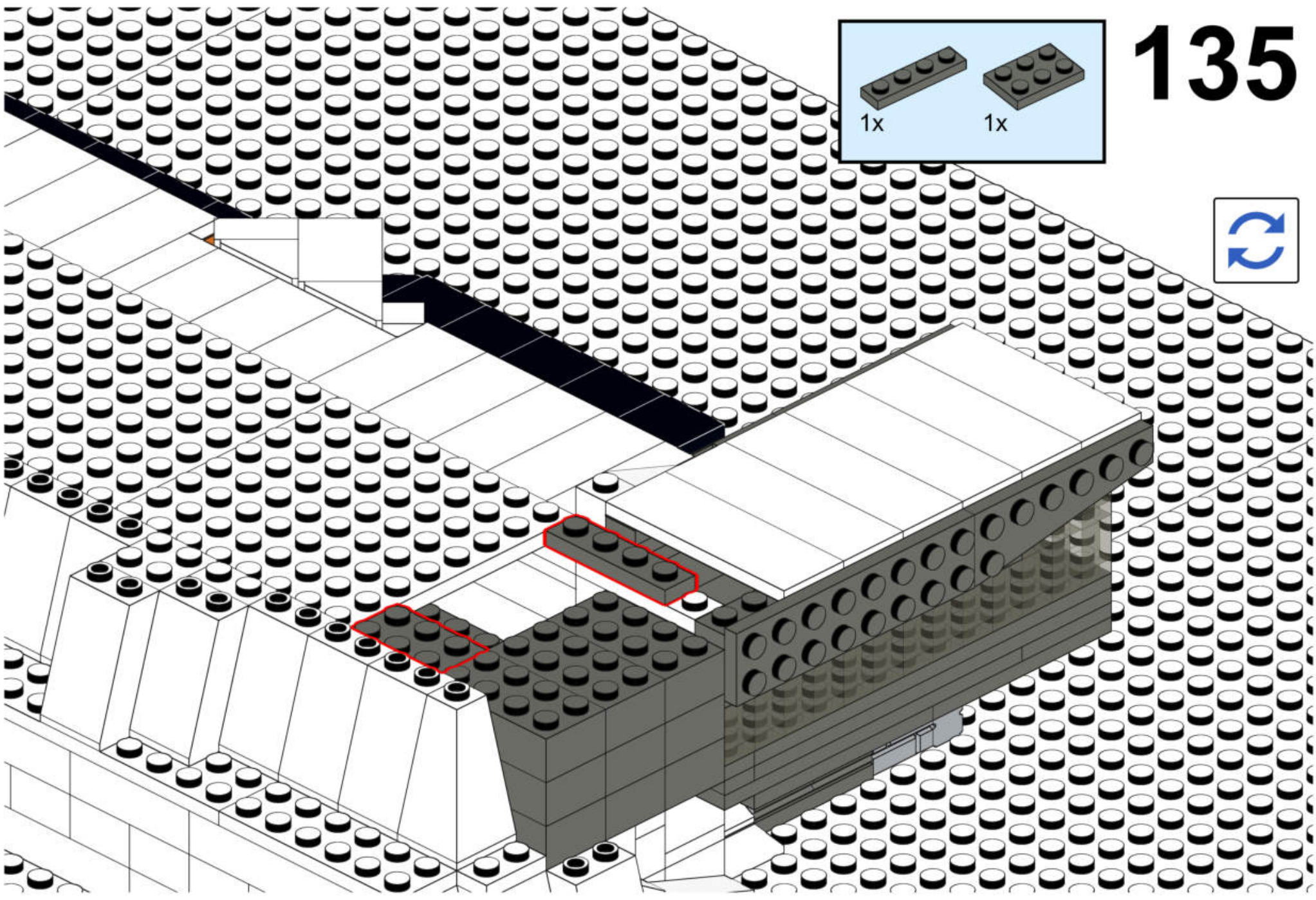
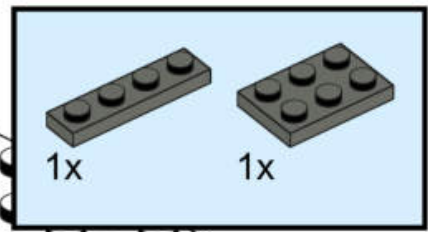



136

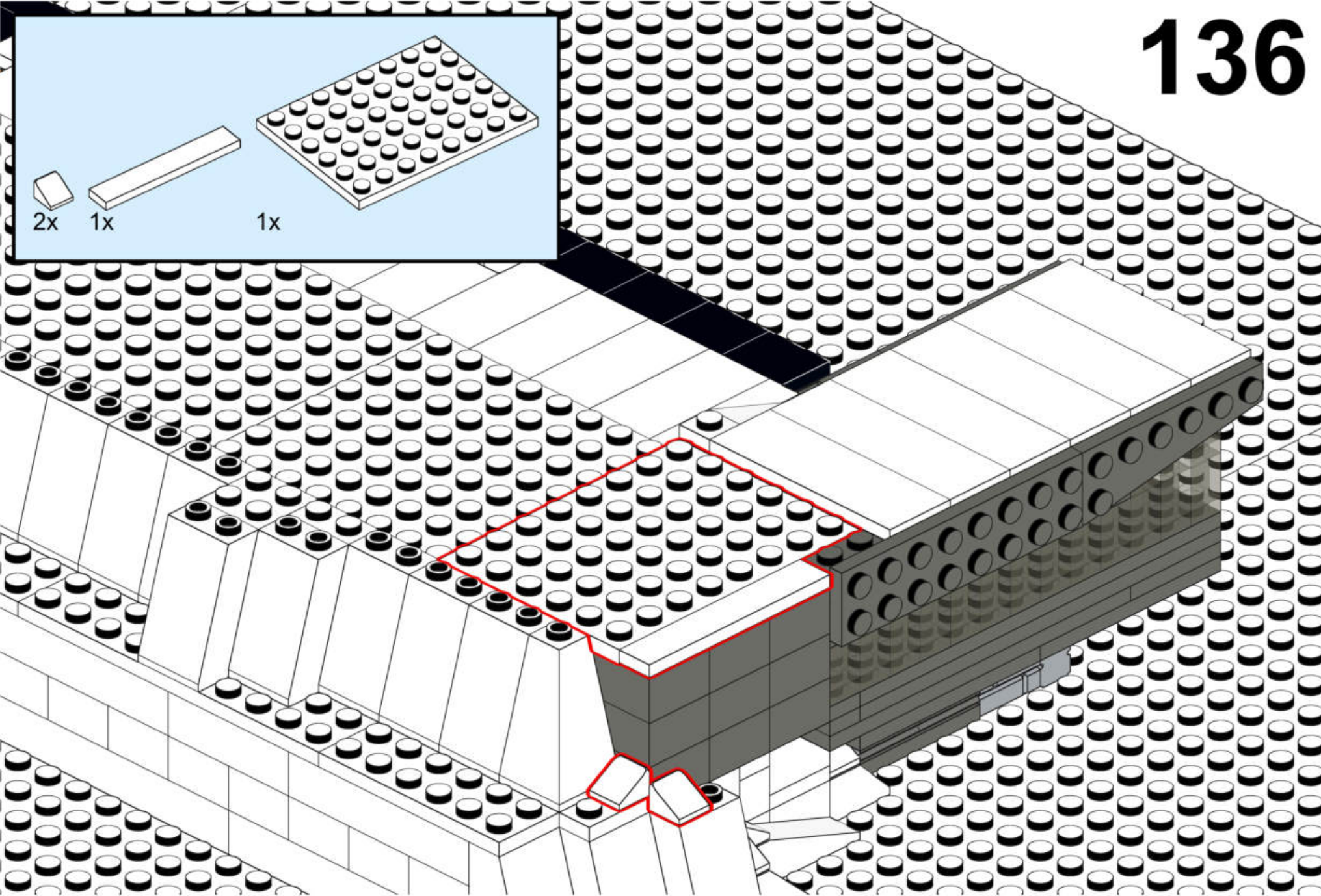



# 137

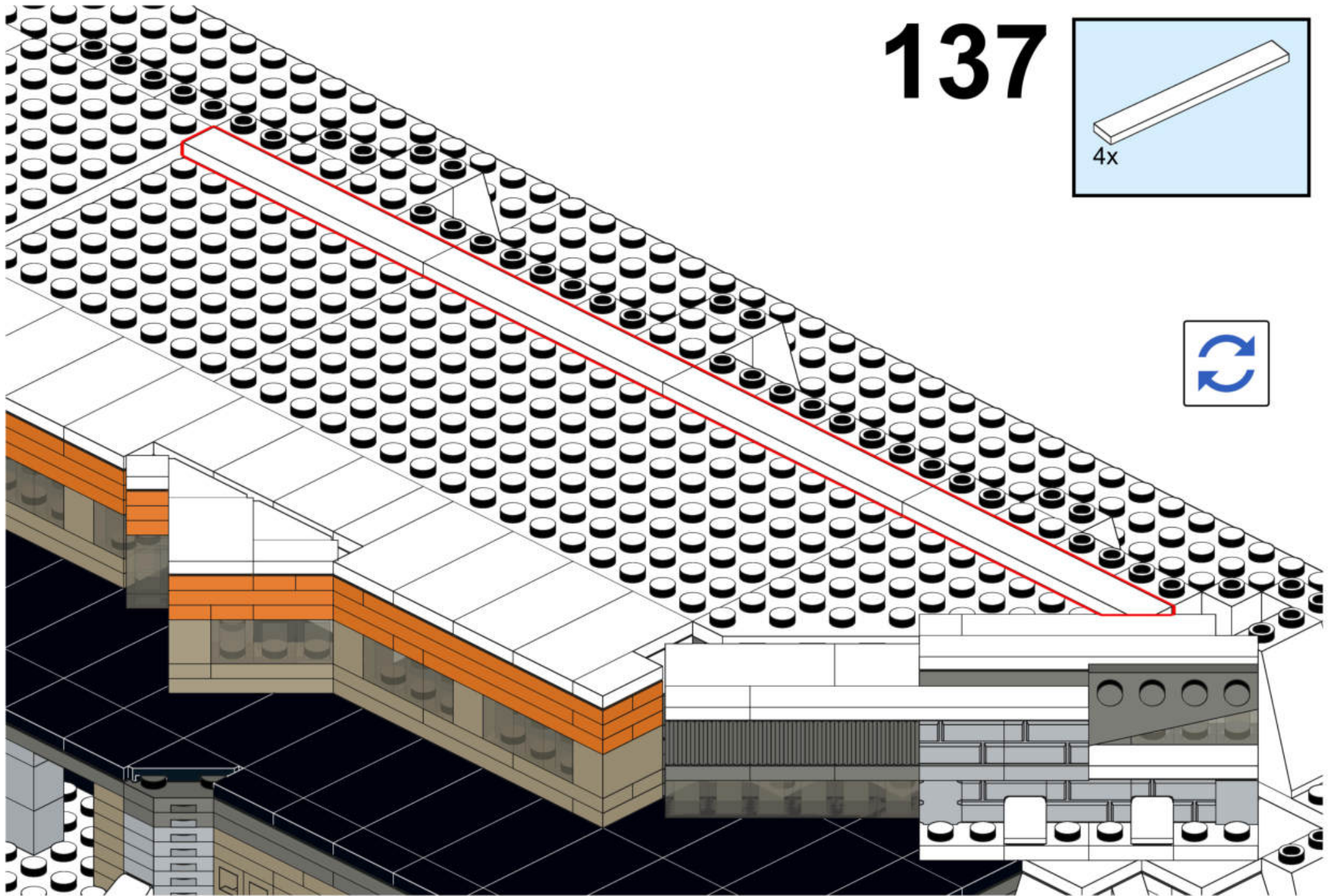
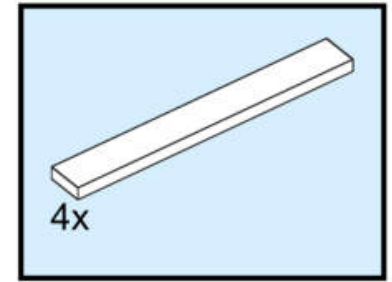



# 138

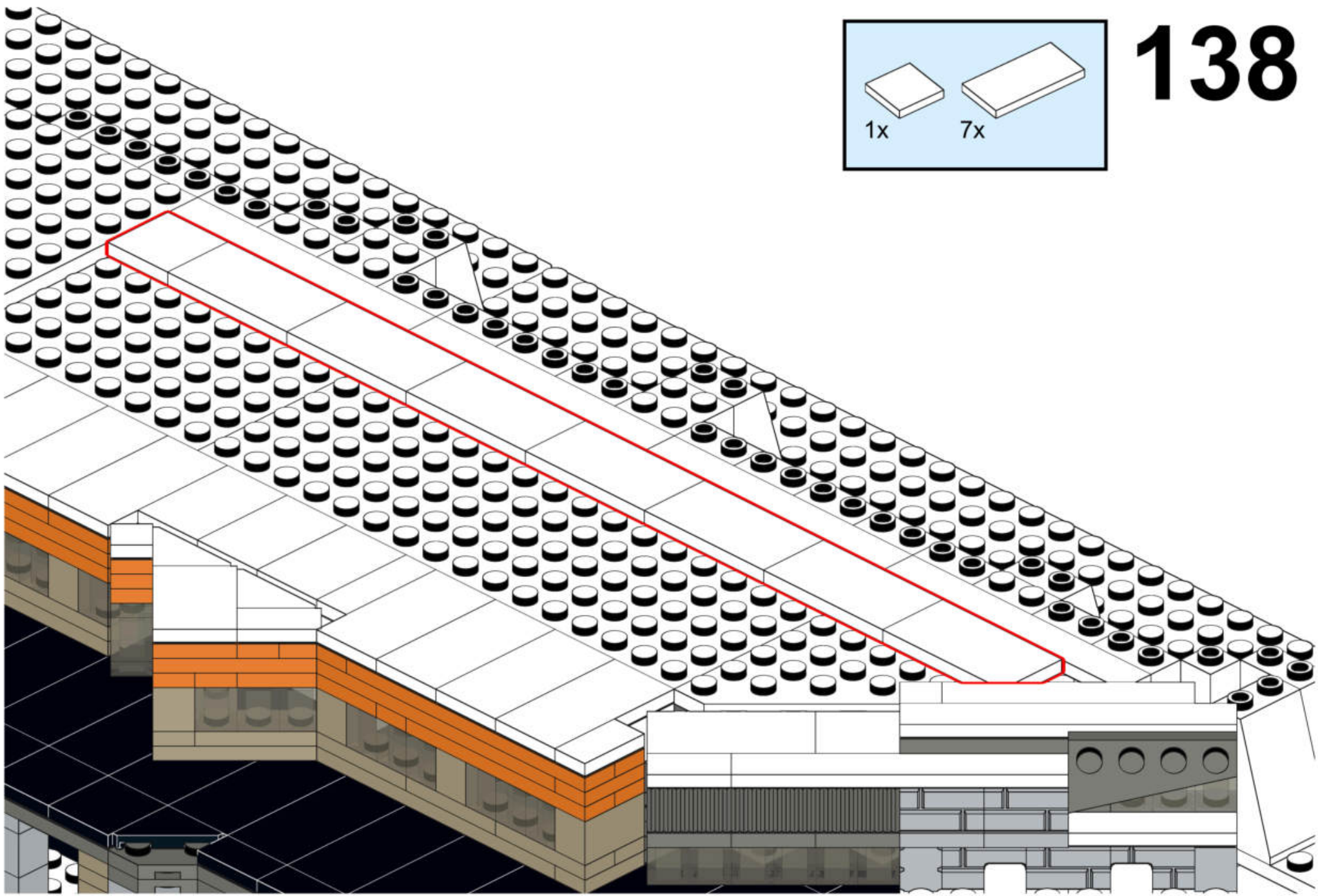
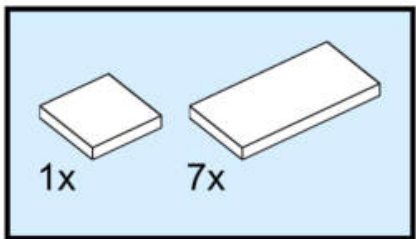



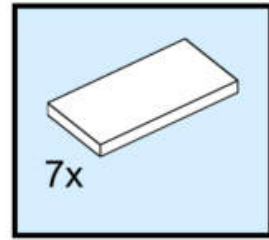
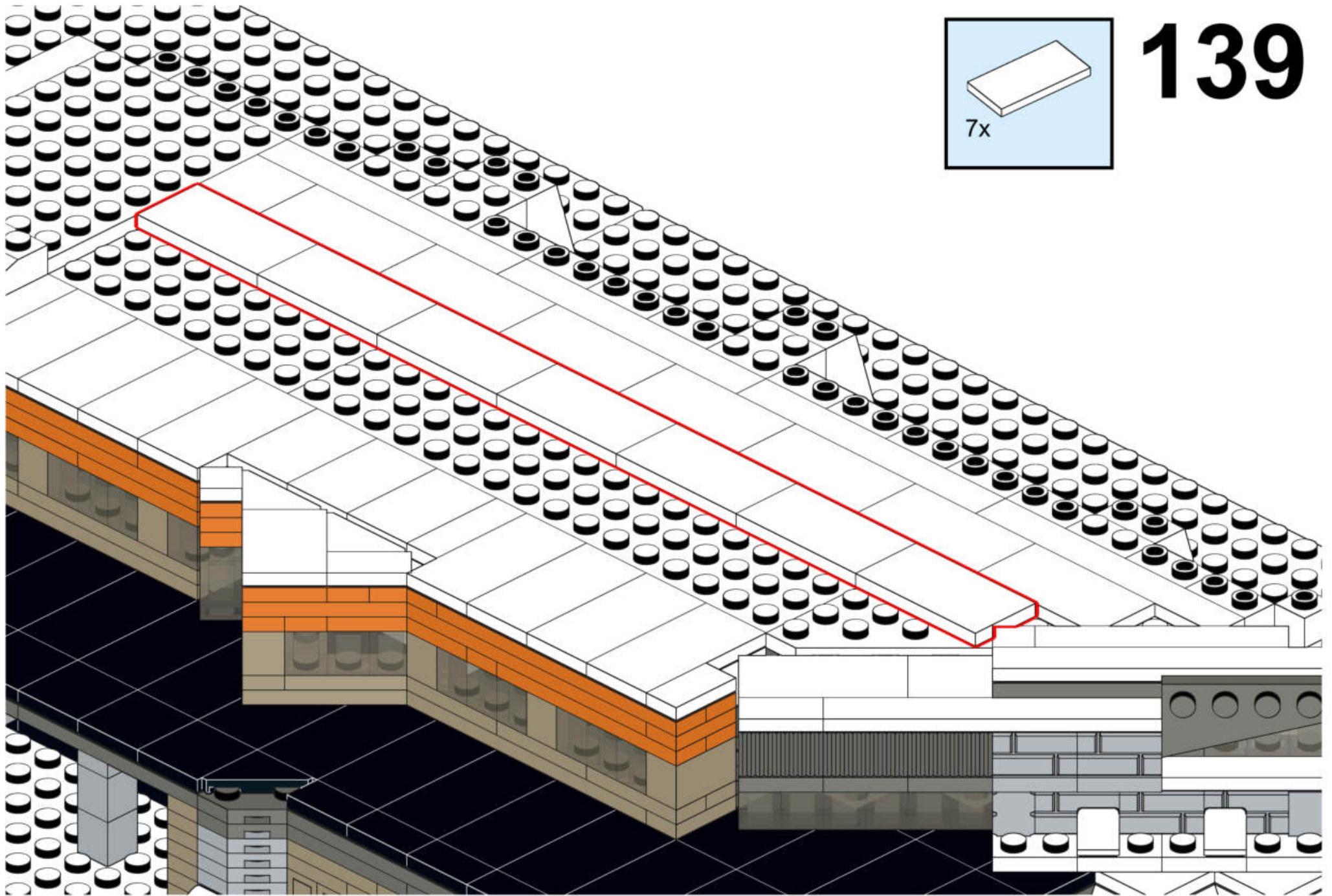

139



# 140

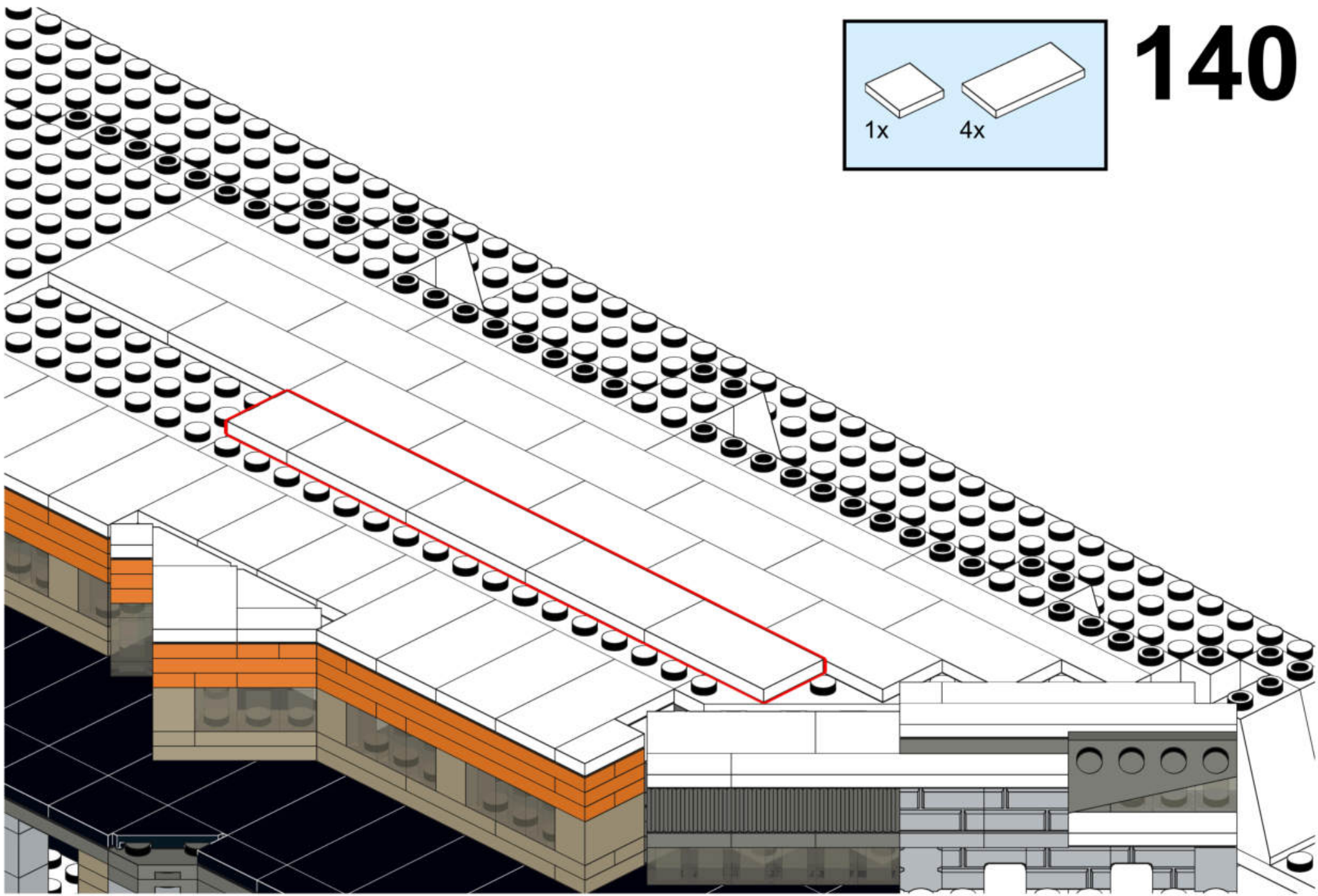
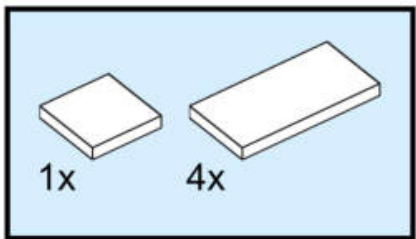



# 141

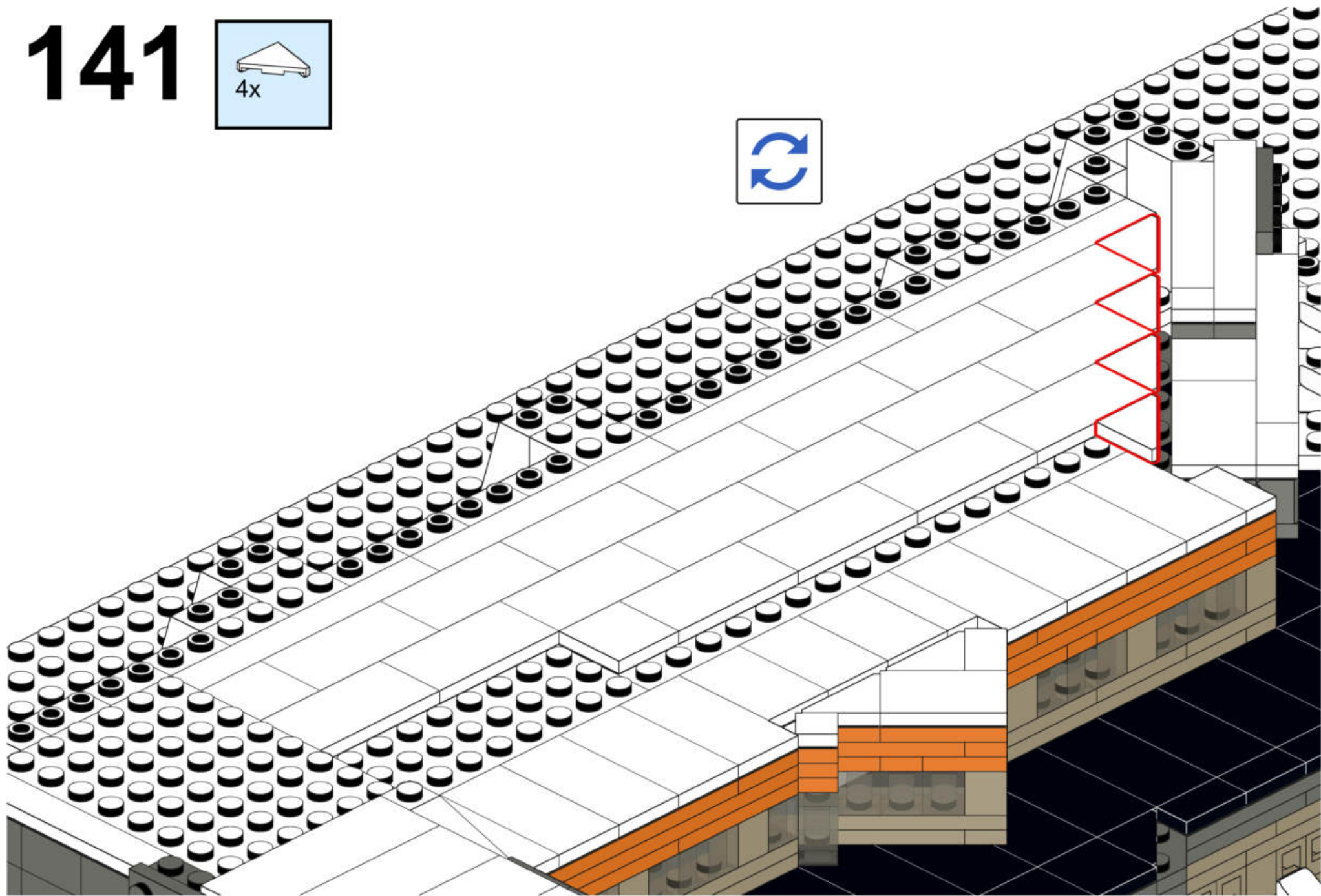
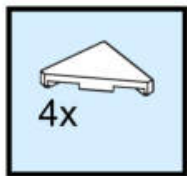



# 142

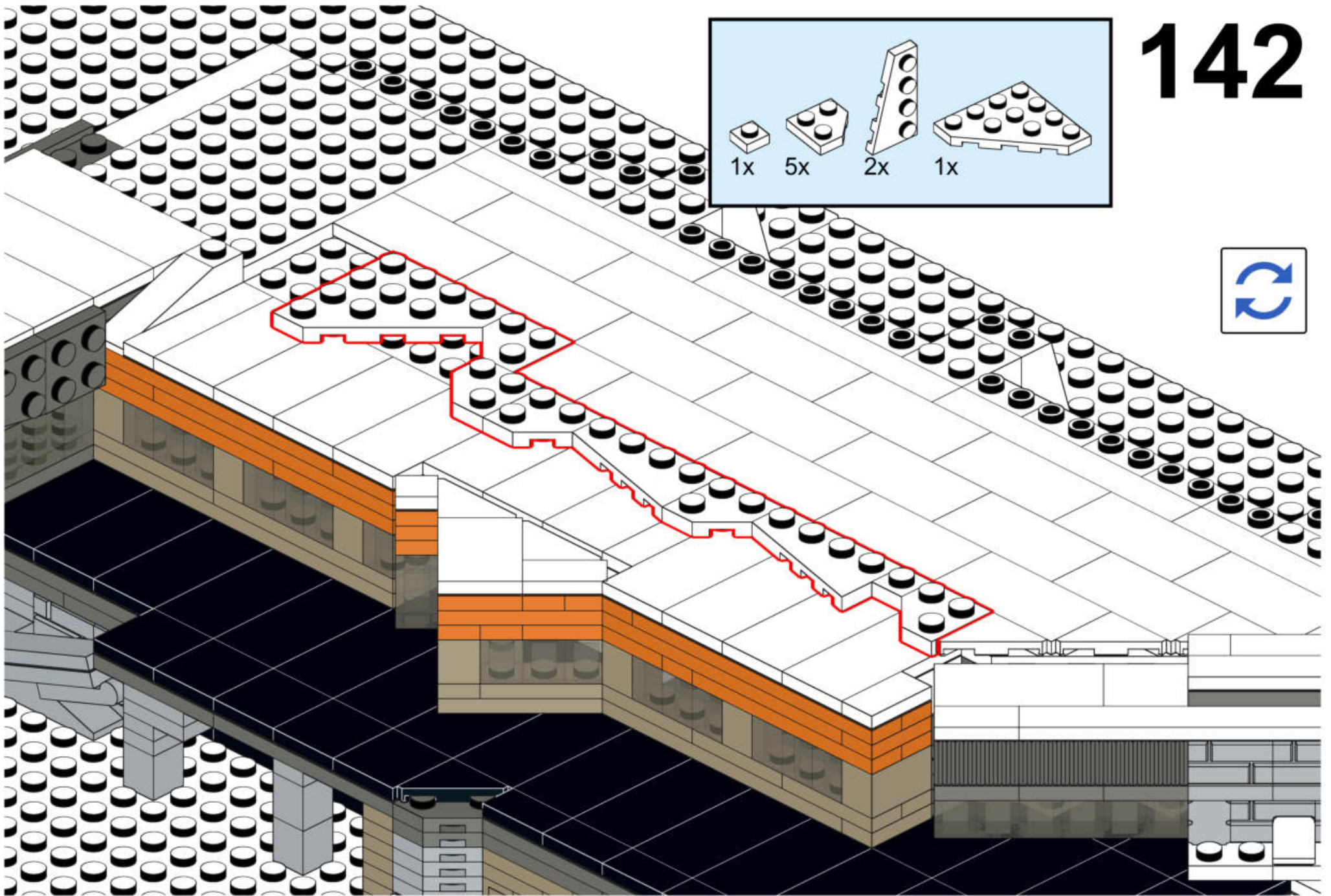
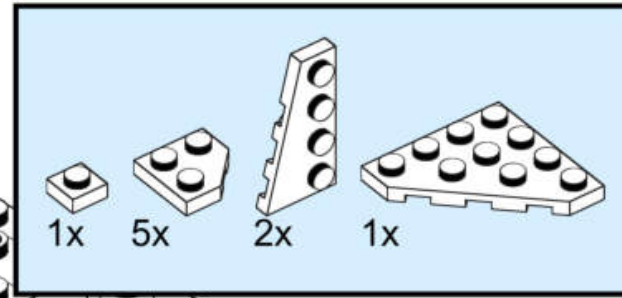



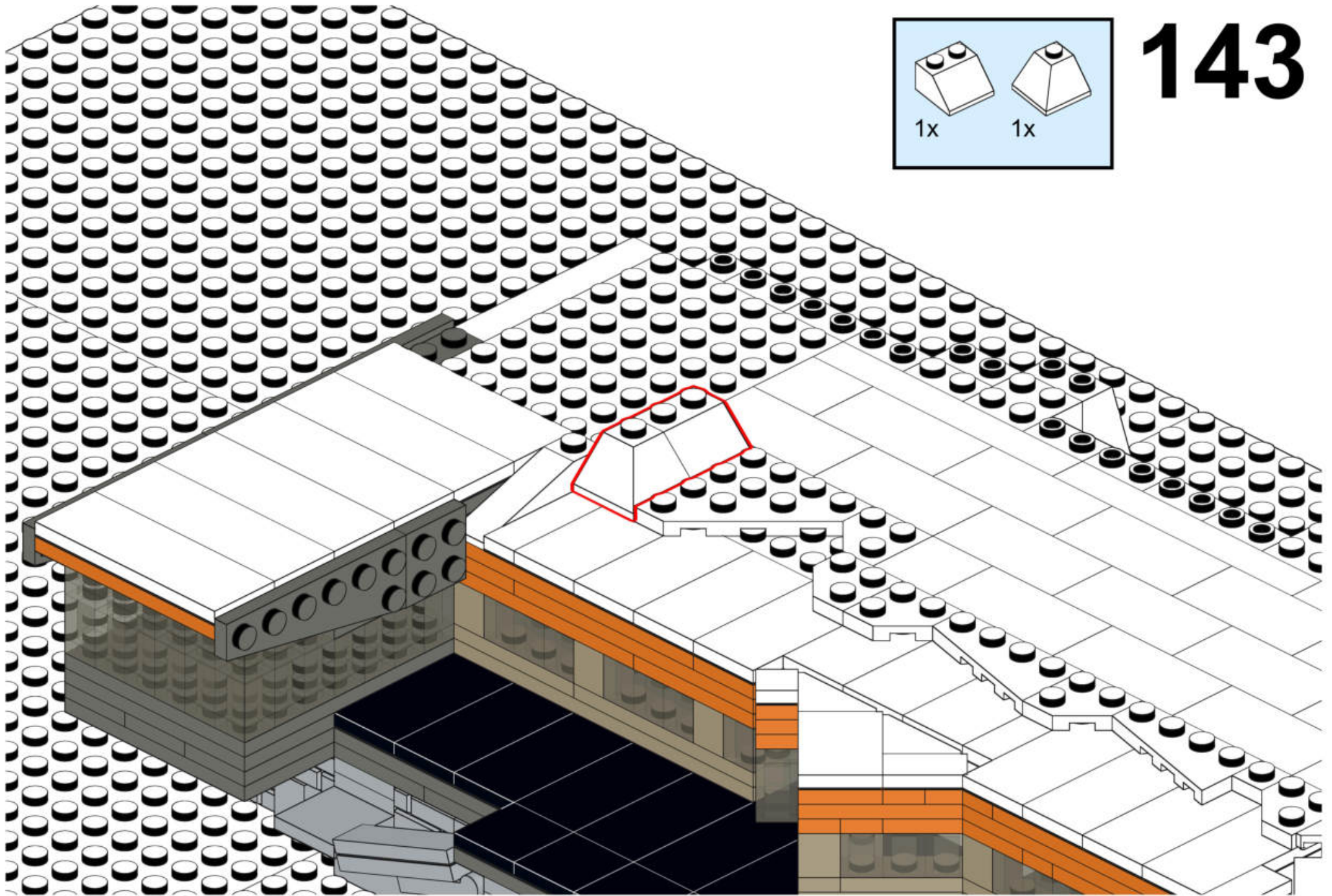



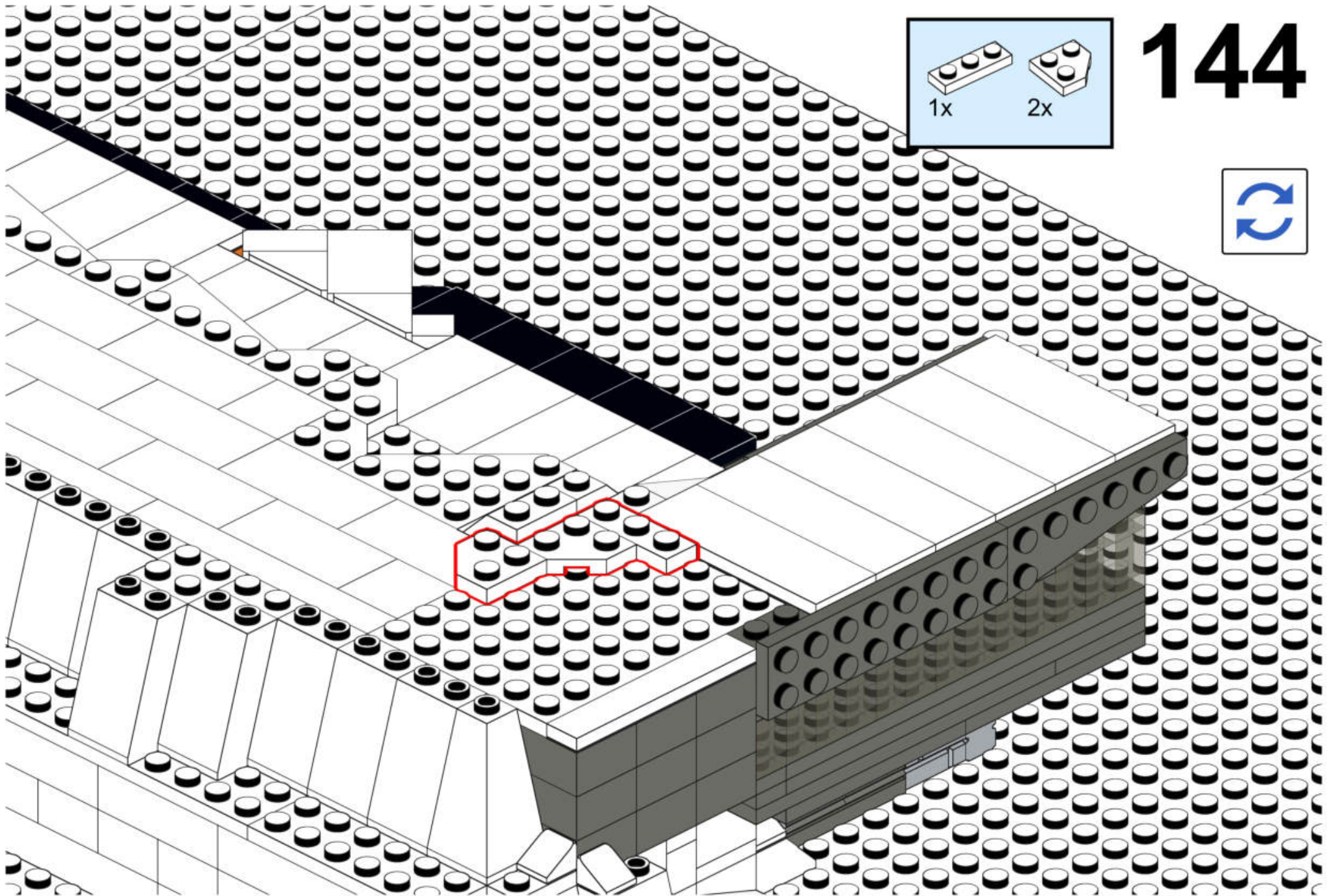



# 145

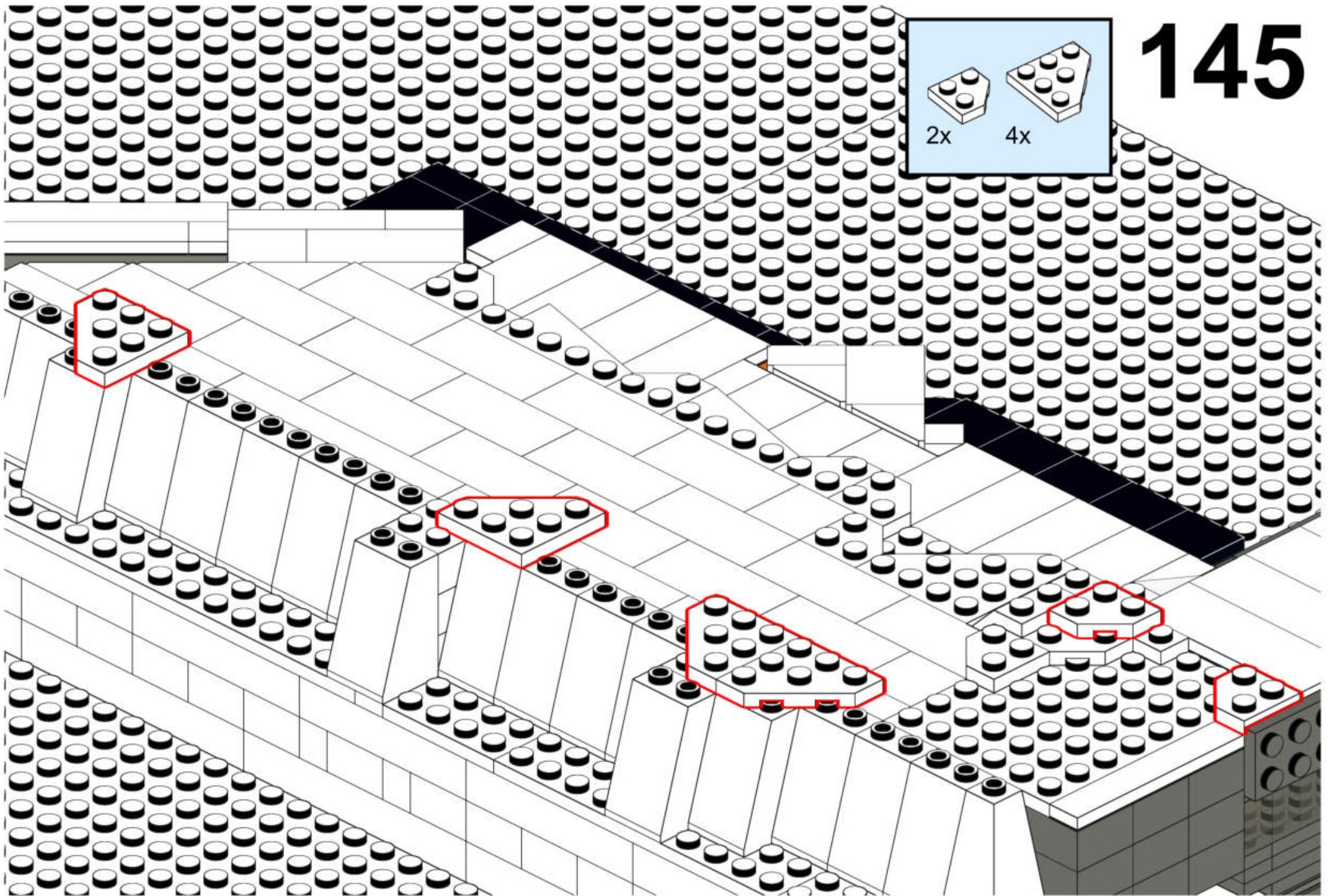
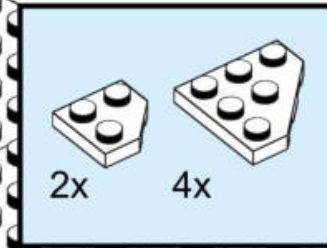



# 146

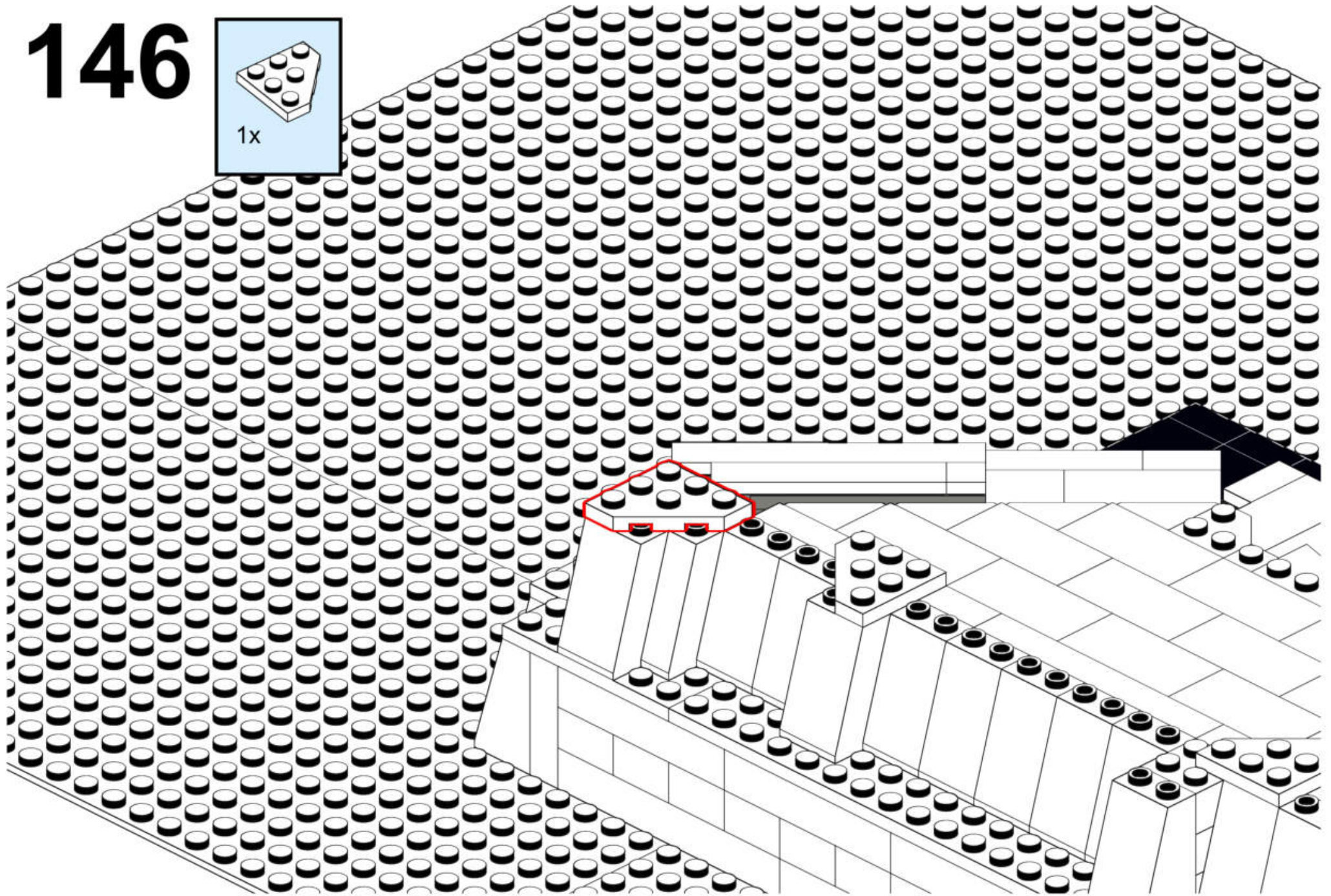
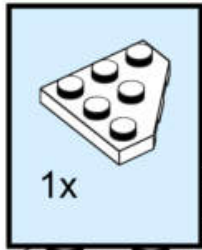



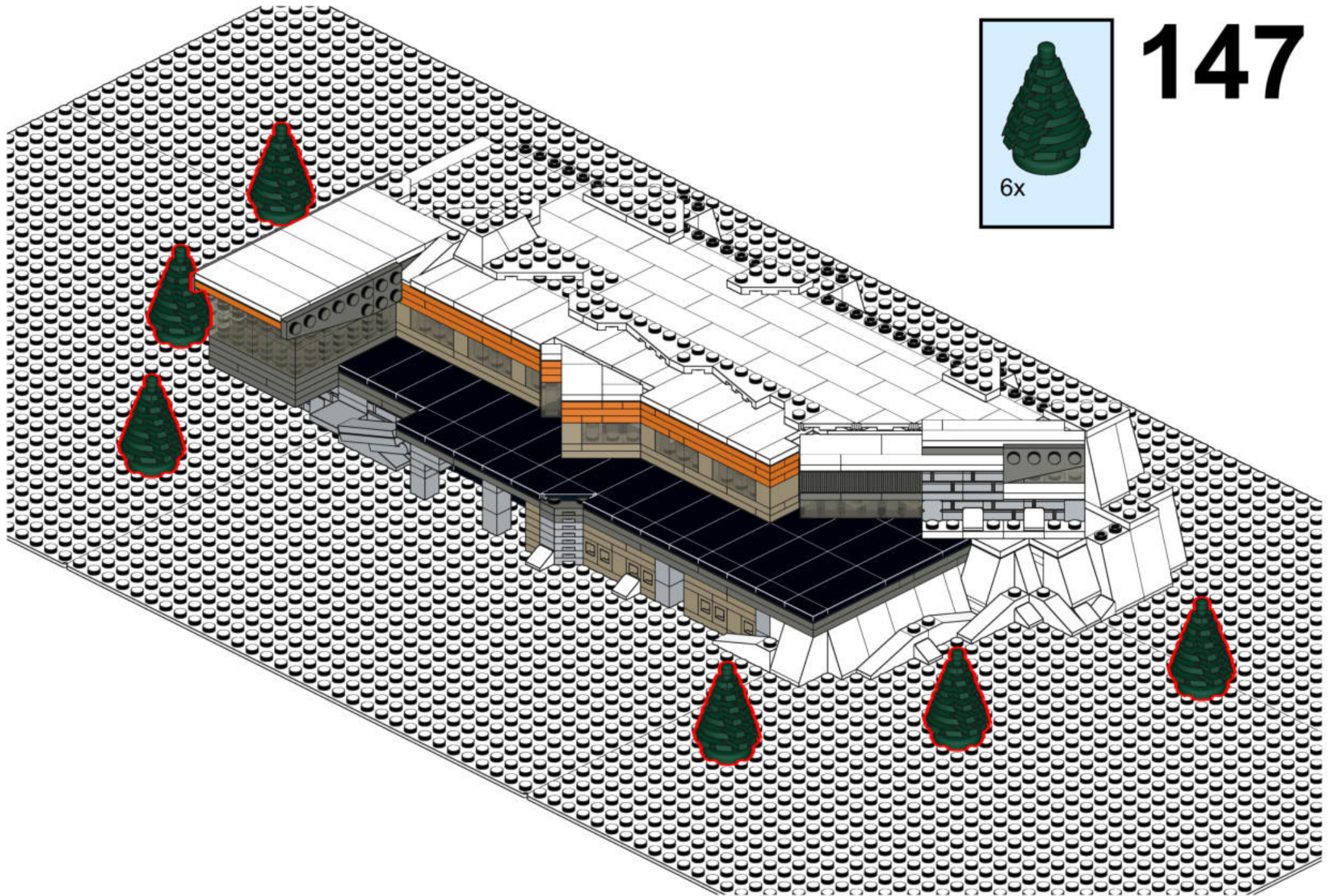

147

